

The Integrated Energy and Communication Systems Architecture

Volume II: Functional Requirements

*Appendix D:
Use Cases (normalized)*

EPRI Project Manager

Joe Hughes

Cosponsor

Electricity Innovation Institute Consortium for Electric Infrastructure to Support a Digital
Society (CEIDS)

DISCLAIMER OF WARRANTIES AND LIMITATION OF LIABILITIES

THIS DOCUMENT WAS PREPARED BY THE ORGANIZATION(S) NAMED BELOW AS AN ACCOUNT OF WORK SPONSORED OR COSPONSORED BY THE ELECTRIC POWER RESEARCH INSTITUTE, INC. (EPRI). NEITHER EPRI, ANY MEMBER OF EPRI, ANY COSPONSOR, THE ORGANIZATION(S) BELOW, NOR ANY PERSON ACTING ON BEHALF OF ANY OF THEM:

(A) MAKES ANY WARRANTY OR REPRESENTATION WHATSOEVER, EXPRESS OR IMPLIED, (I) WITH RESPECT TO THE USE OF ANY INFORMATION, APPARATUS, METHOD, PROCESS, OR SIMILAR ITEM DISCLOSED IN THIS DOCUMENT, INCLUDING MERCHANTABILITY AND FITNESS FOR A PARTICULAR PURPOSE, OR (II) THAT SUCH USE DOES NOT INFRINGE ON OR INTERFERE WITH PRIVATELY OWNED RIGHTS, INCLUDING ANY PARTY'S INTELLECTUAL PROPERTY, OR (III) THAT THIS DOCUMENT IS SUITABLE TO ANY PARTICULAR USER'S CIRCUMSTANCE; OR

(B) ASSUMES RESPONSIBILITY FOR ANY DAMAGES OR OTHER LIABILITY WHATSOEVER (INCLUDING ANY CONSEQUENTIAL DAMAGES, EVEN IF EPRI OR ANY EPRI REPRESENTATIVE HAS BEEN ADVISED OF THE POSSIBILITY OF SUCH DAMAGES) RESULTING FROM YOUR SELECTION OR USE OF THIS DOCUMENT OR ANY INFORMATION, APPARATUS, METHOD, PROCESS, OR SIMILAR ITEM DISCLOSED IN THIS DOCUMENT.

ORGANIZATIONS THAT PREPARED THIS DOCUMENT

General Electric Company led by GE Global Research (Prime Contractor)

Significant Contributions made by

EnerNex Corporation

Hypertek

Lucent Technologies (Partner)

Systems Integration Specialists Company, Inc.

Utility Consulting International (Partner)

ORDERING INFORMATION

Requests for copies of this report should be directed to EPRI Orders and Conferences, 1355 Willow Way, Suite 278, Concord, CA 94520. Toll-free number: 800.313.3774, press 2, or internally x5379; voice: 925.609.9169; fax: 925.609.1310.

Electric Power Research Institute and EPRI are registered service marks of the Electric Power Research Institute, Inc. EPRI. ELECTRIFY THE WORLD is a service mark of the Electric Power Research Institute, Inc. All other trademarks are the property of their respective owners.

Copyright © 2002, 2003, 2004 Electric Power Research Institute, Inc. All rights reserved.

CITATIONS

This document describes research sponsored by EPRI and Electricity Innovation Institute. The publication is a corporate document that should be cited in the literature in the following manner:

THE INTEGRATED ENERGY AND COMMUNICATION SYSTEMS
ARCHITECTURE, EPRI, Palo Alto, CA and Electricity Innovation Institute, Palo Alto,
CA: 2003 {Product ID Number}.

Appendix D – Use Cases (normalized)

This appendix contains a collection of filled-in Domain Templates that are the product of some analysis. The IECSA team normalized these “Use Cases” – that is, the terminology across multiple templates was analyzed and consolidated such that the name of key architectural artifacts is consistent across all templates. Additionally, the requirements for each Use Case step that was analyzed in detail, was added inline to the body of document. The Use Cases are organized and presented here as follows:

CEIDS Portal Project Templates

- D1: Customer Communications Portal Management
- D2: Customer Communications Portal Management – Security Issues
- D3: Customer Communications Portal Management – System Issues
- D4: Customer Communications Portal Management – Telecommunications Issues
- D5: Consumer Portal Scenario P4 Customer Account Move
- D6: Consumer Portal Scenario P5 Customer Sign-up for Demand Reduction Program
- D7: Consumer Portal Scenario P6 Customer Needs Interval Meter
- D8: Consumer Portal Scenario P7
- D9: Consumer Portal Scenario P8
- D10: Consumer Portal Scenario P9

Common Services

- D11: Functional Requirements for Network Management

Consumer

- D12: Demand Response – Utility Commanded Load Control
- D13: Distributed Generation Aggregator
- D14: Permanent Power Quality Measurement
- D15: Power Quality Contracts
- D16: Power Quality Event Notifications
- D17: RTP Baseline Use Case
- D18: RTP – Market Operations Energy Services
- D19: Real-Time Pricing (RTP) Top Level
- D20: RTP – Base RTP Calculation Function
- D21: RTP – Customer’s BAS Optimization
- D22: RTP- DER Management
- D23: Demand Response/Customer Load Control – Non Price Responsive Programs
- D24: RTP - ESP Energy and Ancillary Services Aggregation
- D25: RTP - ESP Customer Specific RTP Calculator
- D26: RTP – Load Forecasting
- D27: RTP – Market Operations Ancillary Services
- D28: Wide-Area Wind Generation Forecasting

DER-ADA

- D29: Functional Requirements for Advanced Distribution Automation with DER (ADA-DER)

D30: Data Acquisition and Control (DAC) Use Case

EDF Engagement

D31: Hours ahead load optimization

Market Operations

D32: Market Operations – Day Ahead Market Operations

D33: Market Operations – Long Term Planning

D34: Market Operations – Medium and Short Term Planning

D35: Market Operations – Overview

Wide Area Measurement and Control

D36: Wide-Area Control System Advanced Auto-Restoration

D37: Wide-Area Monitoring And Control – Automated Control Functions

D38: Contingency Analysis - Baseline

D39: Contingency Analysis - Future

D40: WAMAC Emergency Operations Baseline

D41: Inter-Area Oscillation Damping

D42: System-wide Automatic Voltage Control

D43: Wide Area Control System for the Self-healing Grid (SHG)

D44: Synchro Phasor

D45: Voltage Security

Additional Templates

D46: Market Operations - Post Dispatch

Customer Communications Portal Management

1 Descriptions of Function

Issues confronting an Energy Company's Management Systems responsible for management of Telecommunications and Access Networks to support Customer Communications Portals.

1.1 Function Name

Customer Communications Portal Management

1.2 Function ID

IECSA identification number of the function

C-2.2

1.3 Brief Description

This scenario attempts to describe key issues relevant to the operation of Management Systems in a large Energy Company (Electric and/or Gas and/or Water with several million customers) that provide access to information from and access to control devices located at customer sites. Access to information from devices and access to control one or more devices on the customer premises is provided via Customer Communications Portals.

The key macroscopic issues associated with the management activity are illustrated.

1.4 Narrative

This scenario attempts to describe key issues relevant to the operation of Management Systems in a large Energy Company (Electric and/or Gas and/or Water with several million customers) that provide access to information from and access to control devices located at customer sites. Access to information from devices and access to control one or more devices on the customer premises is provided via Customer Communications Portals.

The entities involved in the communications have separate ownership – meters by distribution companies, power quality information by the customers and the distribution companies, load control devices by the customer and portals by the telecommunications service or other customer site equipment/services provider. Although these owners collaborate on some utility related activities, the nature and purpose of the devices is independent of these applications. For this reason recognition of ownership boundaries and independent management of devices and data needs to be recognized in the management of services that involve their collaboration.

Because some of the information gathered has economic and other consequences, and, since acquisition of information is imperfect, the system needs to accommodate a process of categorization of the quality of data; that categorization may also change over time as data is processed by various entities responsible for using it. A listing of some of the key common macroscopic issues include:

- 1) Recognition of the needs of multiple business entities that need access to Portals, data derived from these portals and related telecommunications and computing infrastructures.
- 2) Ownership of data, i.e., clear identification of who's responsible (Company, person, internal energy business entity or external entity, system) for ensuring that the customer data is correct, and for data that will be used for billing or other business purposes is validated
- 3) Data obtained from customer purposes must be stored and processed in a secure manner with appropriate levels of back up and access control
- 4) Clear identification of business entities (internal energy company or external), applications and individuals that can access data and issue control commands will be established and agreed to by the energy company and the various entities making use of the portals/access networks.
- 5) Access control procedures will be developed and agreed to by the various business entities (internal energy company or external) that obtain data from energy company customer portals or that implement control commands for particular customers or customer classes
- 6) Security Policies will be developed and agreed to by the various business entities (internal energy company or external) that obtain data from energy company customer portals (or databases that store this data) or that implement control commands for particular customers or customer classes. Particular attention should be paid to security requirements either mandated or recommended by both Government and regulatory communities and gleaned from best practices developed by the business community at large.

- 7) Recognition that there may be many existing and future potential Business Models and Business “Standard Practices” for Energy Service provisioning from Regulatory Communities¹. Thus technical requirements for supporting access to Customer Portals and the telecommunications access networks must be flexible enough to accommodate future Energy Services provisioning companies and various entities’ requirements for customer data access.

1.5 Actor (Stakeholder) Roles

Describe all the people (their job), systems, databases, organizations, and devices involved in or affected by the Function (e.g. operators, system administrators, technicians, end users, service personnel, executives, SCADA system, real-time database, RTO, RTU, IED, power system). Typically, these actors are logically grouped by organization or functional boundaries or just for collaboration purpose of this use case. We need to identify these groupings and their relevant roles and understand the constituency. The same actor could play different roles in different Functions, but only one role in one Function. If the same actor (e.g. the same person) does play multiple roles in one Function, list these different actor-roles as separate rows.

<i>Grouping (Community)'</i>		<i>Group Description</i>
<i>Actor Name</i>	<i>Actor Type (person, device, system etc.)</i>	<i>Actor Description</i>

Replicate this table for each logic group.

¹ Requirements will need to be robust for a variety of potential business models since implementation of direct access and other forms of energy industry deregulation are in flux

1.6 Information exchanged

Describe any information exchanged in this template.

<i>Information Object Name</i>	<i>Information Object Description</i>

1.7 Activities/Services

Describe or list the activities and services involved in this Function (in the context of this Function). An activity or service can be provided by a computer system, a set of applications, or manual procedures. These activities/services should be described at an appropriate level, with the understanding that sub-activities and services should be described if they are important for operational issues, automation needs, and implementation reasons. Other sub-activities/services could be left for later analysis.

<i>Activity/Service Name</i>	<i>Activities/Services Provided</i>

1.8 Contracts/Regulations

Identify any overall (human-initiated) contracts, regulations, policies, financial considerations, engineering constraints, pollution constraints, and other environmental quality issues that affect the design and requirements of the Function.

<i>Contract/Regulation</i>	<i>Impact of Contract/Regulation on Function</i>

<i>Policy</i>	<i>From Actor</i>	<i>May</i>	<i>Shall Not</i>	<i>Shall</i>	<i>Description (verb)</i>	<i>To Actor</i>

<i>Constraint</i>	<i>Type</i>	<i>Description</i>	<i>Applies to</i>

2 Step by Step Analysis of Function

Describe steps that implement the function. If there is more than one set of steps that are relevant, make a copy of the following section grouping (Preconditions and Assumptions, Steps normal sequence, and Steps alternate or exceptional sequence, Post conditions)

2.1 Steps to implement function

Name of this sequence.

2.1.1 Preconditions and Assumptions

Describe conditions that must exist prior to the initiation of the Function, such as prior state of the actors and activities

Identify any assumptions, such as what systems already exist, what contractual relations exist, and what configurations of systems are probably in place

Identify any initial states of information exchanged in the steps in the next section. For example, if a purchase order is exchanged in an activity, its precondition to the activity might be 'filled in but unapproved'.

<i>Actor/System/Information/Contract</i>	<i>Preconditions or Assumptions</i>

2.1.2 Steps – Normal Sequence

Describe the normal sequence of events, focusing on steps that identify new types of information or new information exchanges or new interface issues to address. Should the sequence require detailed steps that are also used by other functions, consider creating a new “sub” function, then referring to that “subroutine” in this function. Remember that the focus should be less on the algorithms of the applications and more on the interactions and information flows between “entities”, e.g. people, systems, applications, data bases, etc. There should be a direct link between the narrative and these steps.

The numbering of the sequence steps conveys the order and concurrency and iteration of the steps occur. Using a Dewey Decimal scheme, each level of nested procedure call is separated by a dot ‘.’. Within a level, the sequence number comprises an optional letter and an integer number. The letter specifies a concurrent sequence within the next higher level; all letter sequences are concurrent with other letter sequences. The number specifies the sequencing of messages in a given letter sequence. The absence of a letter is treated as a default ‘main sequence’ in parallel with the lettered sequences.

Sequence 1:

*1.1 - Do step 1
1.2A.1 - In parallel to activity 2 B do step 1
1.2A.2 - In parallel to activity 2 B do step 2
1.2B.1 - In parallel to activity 2 A do step 1
1.2B.2 - In parallel to activity 2 A do step 2
1.3 - Do step 3
1.3.1 - nested step 3.1
1.3.2 - nested step 3.2*

Sequence 2:

*2.1 - Do step 1
2.2 - Do step 2*

#	Event	Primary Actor	Name of Process/Activity	Description of Process/Activity	Information Producer	Information Receiver	Name of Info Exchanged	Additional Notes	IECSA Environments
#	<i>Triggering event? Identify the name of the event.²</i>	<i>What other actors are primarily responsible for the Process/Activity? Actors are defined in section0.</i>	<i>Label that would appear in a process diagram. Use action verbs when naming activity.</i>	<i>Describe the actions that take place in active and present tense. The step should be a descriptive noun/verb phrase that portrays an outline summary of the step. "If ...Then...Else" scenarios can be captured as multiple Actions or as separate steps.</i>	<i>What other actors are primarily responsible for Producing the information? Actors are defined in section0.</i>	<i>What other actors are primarily responsible for Receiving the information? Actors are defined in section0. (Note – May leave blank if same as Primary Actor)</i>	<i>Name of the information object. Information objects are defined in section 1.6</i>	<i>Elaborate architectural issues using attached spreadsheet. Use this column to elaborate details that aren't captured in the spreadsheet.</i>	<i>Reference the applicable IECSA Environment containing this data exchange. Only one environment per step.</i>

2.1.3 Steps – Alternative / Exception Sequences

Describe any alternative or exception sequences that may be required that deviate from the normal course of activities. Note instructions are found in previous table.

#	Event	Primary Actor	Name of Process/Activity	Description of Process/Activity	Information Producer	Information Receiver	Name of Info Exchanged	Additional Notes	IECSA Environments

² Note – A triggering event is not necessary if the completion of the prior step – leads to the transition of the following step.

2.1.4 Post-conditions and Significant Results

Describe conditions that must exist at the conclusion of the Function. Identify significant items similar to that in the preconditions section.

Describe any significant results from the Function

<i>Actor/Activity</i>	<i>Post-conditions Description and Results</i>

2.2 Architectural Issues in Interactions

Elaborate on all architectural issues in each of the steps outlined in each of the sequences above. Reference the Step by number..

2.3 Diagram

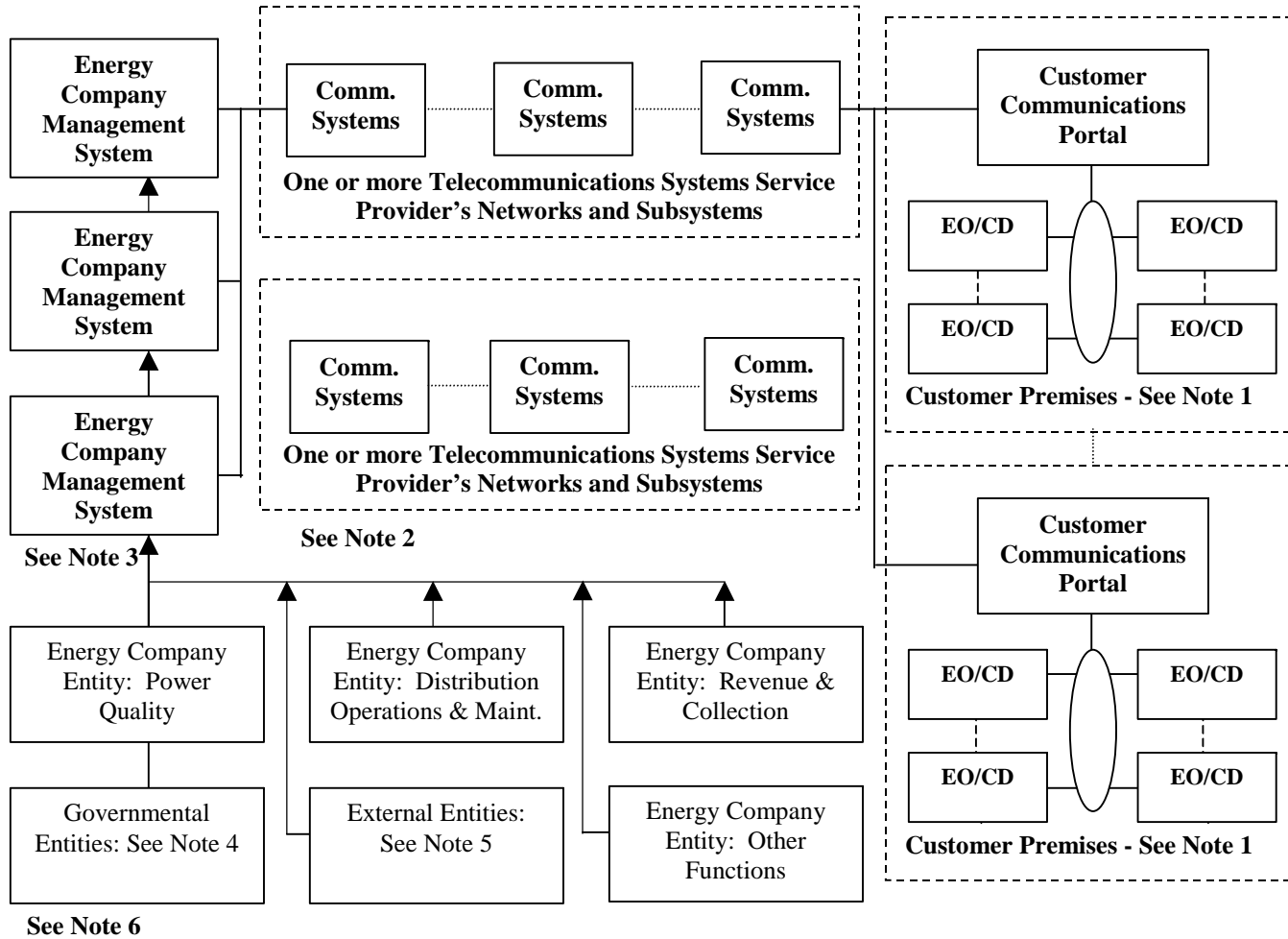

Legend:

EO/CD Energy Company Observable/Controllable Devices
(Systems, Hardware, Software, Applications, etc.)

Notes:

1. EO/CD's may be interconnected to the Customer Communications Portal by various LANs or wired/wireless systems
2. Many diverse Telecommunications Access Networks may be used to connect to Portals
3. Several different Energy Management Systems may be required including an overall "System Manager" (that deals with overall policies, views of various business entities, etc.) a Security Management System (that deals with authorization, security, reporting and related issues) and a Network Management System (that deals with the Customer Portal Access Networks and data communications issues)
4. Several Governmental Entities will need to access certain information that will be obtained via the Customer Communications Portals. Some of these are: PUC's, FERC, FTC, FCC, FBI, DHS, NIST, various State and Local Governmental Agencies, etc.
5. Several Entities outside of the Energy Companies will need to access certain information that will be obtained via the Customer Communications Portals. Some of these are: ISO, RTO, Independent Power Generators, various appliance manufacturers, etc
6. All of the Entities shown in the boxes are routed through the various Key Management Systems. This is meant to signify that the policies, procedures, access control rights, security and other enablers and constraints of these Management Systems will tailor the views of the data that these entities can access and the control messages that they are authorized to initiate. This does not imply that there will actually be individual computer/software systems that these entities must be routed through. The diagram represents a logical view , not a physical view.

3 Auxiliary Issues

3.1 References and contacts

Documents and individuals or organizations used as background to the function described; other functions referenced by this function, or acting as "sub" functions; or other documentation that clarifies the requirements or activities described. All prior work (intellectual property of the company or individual) or proprietary (non-publicly available) work must be so noted.

ID	Title or contact	Reference or contact information
[1]		

[2]		
-----	--	--

3.2 Action Item List

As the function is developed, identify issues that still need clarification, resolution, or other notice taken of them. This can act as an Action Item list.

ID	Description	Status
[1]		
[2]		

3.3 Revision History

For reference and tracking purposes, indicate who worked on describing this function, and what aspect they undertook.

No	Date	Author	Description
0.			

Customer Communications Portal Management – Security Issues

1 Descriptions of Function

Issues confronting an Energy Company's Management Systems responsible for management of Telecommunications and Access Networks to support Customer Communications Portals.

1.1 Function Name

Customer Communications Portal Management: Security Issues

1.2 Function ID

IECSA identification number of the function

C-2.2

1.3 Brief Description

This scenario attempts to describe key issues relevant to the operation of Management Systems in a large Energy Company (Electric and/or Gas and/or Water with several million customers) that provide access to information from and access to control devices located at customer sites. Access to information from devices and access to control one or more devices on the customer premises is provided via Customer Communications Portals.

Here, we focus on security management issues.

1.4 Narrative

The key issue for the development of a security strategy and a set of policies that guide the development of a security plan is to clearly define the risks inherent in developing a network as described in this paper. This networking model is one that provides information and access to control actions involving significant numbers of Customer Communications Portals and many users both internal to the Energy Company and to outside entities.

In order to help frame the description of the security management issues, four major components of security; Confidentiality, Authentication, Nonrepudiation and Data Integrity, along with some examples of how they are pertinent to the Customer Portal environment will be reviewed:

Confidentiality deals with the need to keep information secret, i.e., keeping information from unauthorized users. In the context of the Customer Communications Portal there will be a great deal of information that will need to be kept confidential. For example, a particular customer's (say, a manufacturer of a certain type of widget) energy usage would be of great interest to a competitor as it would be an indication of inventory build up or increased sales of their product, likewise a reduced level of energy consumption could indicate problems. There are many other instances of similar situations. For each of these situations, it is imperative that no one other than the Energy Company, other authorized users and the particular customer should have access to energy usage and/or other information pertaining to that particular Customer. Given that there are many different Access Network components, data storage components, and internal Energy Company networks and perhaps several wireless network components, weakness in each or any of these components might enable someone desiring this information, access to the information.

Authentication in the context of the Customer Communications Portal environment is a mechanism that uniquely identifies who or what entity is trying to access information over the Customer Communications Portal networks and/or related databases. For example, is a Customer who accesses Customer Portal information over the Internet or the Customer Communications Portal Access Network(s) really the individual or entity that is implied by the transaction taking place? Or is it an imposter (perhaps an interested competitor) who is trying to obtain information valuable for his or her own purposes? There are many similar situations in a network and systems as complex as the Customer Communications Portal/Access Networks. Authentication is especially critical in those instances where the users need to access Customer Portal information over the Internet or via connections from another data communications network, as each network has its own security domain, policies and thus, providing a common level of security integration will be a very difficult task. For example a Regulator accessing Customer Communications Portal information initiating a session from an agency network workstation accessing an Energy Company server via the Internet is bridging several networks with varying levels of security. Policies, access control mechanisms and security mechanisms must be in place to enable authenticated users access to the information that they need. But, mechanisms must be in place to ensure that imposters cannot obtain this access. Authentication is a key component of this capability.

Nonrepudiation is a mechanism that provides the means for a third party to verify the integrity and origin of data and the proof of delivery of this data. For example, if an authorized individual representing an ISO requests a large industrial customer to provide a certain level of auxiliary power services, and the customer agrees, the use of nonrepudiation services will provide a record of the request and response and the fact that the transaction took place. Neither the ISO representative nor the customer can at a later date deny that the request and its acceptance was made. In other words, it can be verified that the ISO representative indeed made the

request, the Customer indeed agreed to provide the services and that the request, the individuals were in fact the ones being represented in the transaction and that the requests and response did take place. In order to accomplish this, technologies such as public-key cryptography, digital signatures and digital notary or equivalent must be employed.

Data Integrity is protected if the Security Management System if it ensures that data conveyed over a network is complete and whole and that an unauthorized user or system has not modified it, added to it, or deleted it during its transmission or storage. In the context of the Customer Portal environment the Security Management System Data must ensure that data transmitted over the Customer Portal Access Network or data that has been stored in any Computer System or storage device that is part of associated systems is indeed whole and that it has not been modified or added to in any way. Maintaining Data Integrity is an essential element in the operation of the Customer Communications Portal, Access Network and related computing systems. For example, If there are ISO requests for local generation to meet system needs, it is critical that any records of the transaction, along with data relative to the energy flows, duration, etc. be accurately and transmitted in it's entirety across the network and accurately stored in appropriate databases. It will be essential that the data is complete and whole and that it has not been modified added to or deleted during its transmission and storage. As many of these transactions may be taking place in a semi or fully automated fashion, with little human interaction it is imperative that security mechanisms such as Data Integrity be in place to ensure accuracy and reliability of any critical data transmitted over the Access Data networks and stored in Customer Communications Portal/related databases.

Auditability in the context of the Customer Communications Portal environment is a mechanism that provides records of activities that can attest to the security services. In other words a security audit tool or set of tools will enable logging of any attempted security breach from within or outside of the Energy Company networking environment. The audit trail should include information on the type of breach such as host break-in, network break-in, multiple incorrect passwords and user ID attempts, etc.

A Security System Manager through the use of a Security Management System faces many difficult tasks in order to provide access to Customer Communications Portal data in a manner that ensures that only authorized uses have access to the data, and have the capability to download software or issue commands to Customer Portals. There are several broad concerns and actions the Security Manager must undertake, to initially get the system up and running and then to effectively operate the system on an ongoing basis. The Security Management System must be configured to implement the appropriate operating and security policies as determined and agreed to by the key business entities and as defined in the System Manager by:

- 1) Defining the risks to the Energy Company, external entities, Government Agencies and Regulators and other users of Customer Portal data. Each Energy Company will have different networking and computing environments, so there will be different levels of risk depending on each company's particular environment. Following is a listing of some of the risks that are common to many corporate organizations. It is by no means intended to be a comprehensive listing:

- a) **Data Theft.** Any data stored on a computing device or routed or transmitted through a network (and especially if the data can be accessed via the Internet) is vulnerable to theft. The key issue to consider is how valuable is the data and how much effort and cost is it worth expending to protect this data. In an Energy Company environment data theft can result in significant financial costs, some data is protected by Regulatory statues the disclosure of this data could result in fines or other penalties, competitive advantage could be lost for it's customers and there can be exposure to fraud for both the company and its customers. It is critical that the owner(s) of this data make an evaluation of how valuable the data is to them before developing security plans. Security systems used to implement Authentication and Data Integrity in the Customer Portal systems will help mitigate Data Theft.
 - b) **Data Destruction:** It is possible that data can be deleted through some action of a user. This will require that backup media be scanned to retrieve the data or in a worst-case scenario, that the data must be recreated (if possible). In Energy Company environments data destruction could lead to serious consequences. The key issue again, is how valuable is the data and how much effort and cost is it worth expending to protect this data. Security systems used to implement Authentication and Data Integrity in the Customer Portal systems will also help mitigate Data Destruction.
 - c) **Loss of Network or System integrity:** It is possible that by various means that hackers have at their disposal (Trojan Horse, etc.) the integrity of a key host or other device is compromised or disabled. This can be a very serious problem that can take a significant amount of time to analyze and repair, the cost of which can be quite expensive. There is no one tool that can address these threats. Use of firewalls and other perimeter defense mechanisms, Tools that uncover and disable viruses, worms, Trojan horse software and other attack software are critical to minimizing these risks.
 - d) **Loss of Network or System accessibility and availability:** If key components of the Network are disabled by intruder action or by configuration changes, accessibility and availability of the network and access to the data can be lost for some time. There is no one tool that can address these threats. Use of firewalls and other perimeter defense mechanisms, Tools that uncover and disable viruses, worms, Trojan horse software and other attack software are critical to minimizing these risks. It is critical that access to any controlling software residing in any portion of the Customer Portal Access Networks be restricted to only authorized users. Authentication mechanisms should be employed to enable access. Computing systems should to the extent possible utilize access control mechanisms on any network interface. Auditing tools should be provided on these computing systems as well as integrity checking tools so that any unauthorized activity can be quickly identified.
- 2) **Assigning and managing Access Classes and authorization levels that reflect the policies defined by the System Manager, including but not limited to the following tasks:**
 - a) **Assigning User Identifications and Passwords and monitor password usage to ensure that they are changed on a periodic basis by all users,**

- b) Ensuring that application log-in procedures are followed by all users,
 - c) Ensuring that appropriate encryption mechanisms (Triple DES, AES, Private Key, etc) are employed on a per entity, per user and application basis
 - d) Implement a Security Key Management system for those situations that make it appropriate to utilize Public Key Encryption in order to meet the security requirements defined by the System Manager.
 - i) Provide mechanisms to recover lost keys. This could take the form of a Key Escrow System where several parties hold portions of specific encryption keys. For example if data from a Customer Portal is especially sensitive and it was encrypted and the Customer Key was lost, then the parties that held portions of the key can be enlisted to provide their portions of the key in order to ensure that the Customer's data can be recovered. The portions of the key held by other parties would not be sufficient to individually decrypt the data, but when combined the key and the encrypted data can be recovered. Note that this is only an example of what mechanisms might be employed to cover this type of contingency.
- 3) Implementing firewalls and building perimeter protection systems that will block unauthorized users from gaining access to networks, databases and other resources that may impair the operation of the Customer Portal System and integrity of the data. Note this is a task that cannot be predefined, in any given Energy Company environment there may be several computer systems and databases that must be protected from unauthorized access from both internal and external entities and individuals. Unfortunately, the more segmentation the higher the engineering and maintenance costs.
- 4) Implementing Virtual Private Network connectivity for outside entities and individuals Regulators, Governmental Agencies, etc. outside of the Energy Company networking environment to enable access to data they are authorized to obtain. Authentication mechanisms will need to be used in many cases to enable adequate levels of security protection.

1.5 Actor (Stakeholder) Roles

Describe all the people (their job), systems, databases, organizations, and devices involved in or affected by the Function (e.g. operators, system administrators, technicians, end users, service personnel, executives, SCADA system, real-time database, RTO, RTU, IED, power system). Typically, these actors are logically grouped by organization or functional boundaries or just for collaboration purpose of this use case. We need to identify these groupings and their relevant roles and understand the constituency. The same actor could play different roles in different Functions, but only one role in one Function. If the same actor (e.g. the same person) does play multiple roles in one Function, list these different actor-roles as separate rows.

<i>Grouping (Community)</i>		<i>Group Description</i>
<i>Actor Name</i>	<i>Actor Type (person, device, system etc.)</i>	<i>Actor Description</i>

Replicate this table for each logic group.

1.6 Information exchanged

Describe any information exchanged in this template.

<i>Information Object Name</i>	<i>Information Object Description</i>

1.7 Activities/Services

Describe or list the activities and services involved in this Function (in the context of this Function). An activity or service can be provided by a computer system, a set of applications, or manual procedures. These activities/services should be described at an appropriate level, with the understanding that sub-activities and services should be described if they are important for operational issues, automation needs, and implementation reasons. Other sub-activities/services could be left for later analysis.

<i>Activity/Service Name</i>	<i>Activities/Services Provided</i>

1.8 Contracts/Regulations

Identify any overall (human-initiated) contracts, regulations, policies, financial considerations, engineering constraints, pollution constraints, and other environmental quality issues that affect the design and requirements of the Function.

<i>Contract/Regulation</i>	<i>Impact of Contract/Regulation on Function</i>

<i>Policy</i>	<i>From Actor</i>	<i>May</i>	<i>Shall Not</i>	<i>Shall</i>	<i>Description (verb)</i>	<i>To Actor</i>

<i>Constraint</i>	<i>Type</i>	<i>Description</i>	<i>Applies to</i>

2 Step by Step Analysis of Function

Describe steps that implement the function. If there is more than one set of steps that are relevant, make a copy of the following section grouping (Preconditions and Assumptions, Steps normal sequence, and Steps alternate or exceptional sequence, Post conditions)

2.1 Steps to implement function

Name of this sequence.

2.1.1 Preconditions and Assumptions

Describe conditions that must exist prior to the initiation of the Function, such as prior state of the actors and activities

Identify any assumptions, such as what systems already exist, what contractual relations exist, and what configurations of systems are probably in place

Identify any initial states of information exchanged in the steps in the next section. For example, if a purchase order is exchanged in an activity, its precondition to the activity might be 'filled in but unapproved'.

<i>Actor/System/Information/Contract</i>	<i>Preconditions or Assumptions</i>

2.1.2 Steps – Normal Sequence

Describe the normal sequence of events, focusing on steps that identify new types of information or new information exchanges or new interface issues to address. Should the sequence require detailed steps that are also used by other functions, consider creating a new “sub” function, then referring to that “subroutine” in this function. Remember that the focus should be less on the algorithms of the applications and more on the interactions and information flows between “entities”, e.g. people, systems, applications, data bases, etc. There should be a direct link between the narrative and these steps.

The numbering of the sequence steps conveys the order and concurrency and iteration of the steps occur. Using a Dewey Decimal scheme, each level of nested procedure call is separated by a dot ‘.’. Within a level, the sequence number comprises an optional letter and an integer number. The letter specifies a concurrent sequence within the next higher level; all letter sequences are concurrent with other letter sequences. The number specifies the sequencing of messages in a given letter sequence. The absence of a letter is treated as a default ‘main sequence’ in parallel with the lettered sequences.

Sequence 1:

*1.1 - Do step 1
1.2A.1 - In parallel to activity 2 B do step 1
1.2A.2 - In parallel to activity 2 B do step 2
1.2B.1 - In parallel to activity 2 A do step 1
1.2B.2 - In parallel to activity 2 A do step 2
1.3 - Do step 3
1.3.1 - nested step 3.1
1.3.2 - nested step 3.2*

Sequence 2:

*2.1 - Do step 1
2.2 - Do step 2*

#	Event	Primary Actor	Name of Process/Activity	Description of Process/Activity	Information Producer	Information Receiver	Name of Info Exchanged	Additional Notes	IECSA Environments
#	<i>Triggering event? Identify the name of the event.¹</i>	<i>What other actors are primarily responsible for the Process/Activity? Actors are defined in section0.</i>	<i>Label that would appear in a process diagram. Use action verbs when naming activity.</i>	<i>Describe the actions that take place in active and present tense. The step should be a descriptive noun/verb phrase that portrays an outline summary of the step. "If ...Then...Else" scenarios can be captured as multiple Actions or as separate steps.</i>	<i>What other actors are primarily responsible for Producing the information? Actors are defined in section0.</i>	<i>What other actors are primarily responsible for Receiving the information? Actors are defined in section0. (Note – May leave blank if same as Primary Actor)</i>	<i>Name of the information object. Information objects are defined in section 1.6</i>	<i>Elaborate architectural issues using attached spreadsheet. Use this column to elaborate details that aren't captured in the spreadsheet.</i>	<i>Reference the applicable IECSA Environment containing this data exchange. Only one environment per step.</i>

2.1.3 Steps – Alternative / Exception Sequences

Describe any alternative or exception sequences that may be required that deviate from the normal course of activities. Note instructions are found in previous table.

#	Event	Primary Actor	Name of Process/Activity	Description of Process/Activity	Information Producer	Information Receiver	Name of Info Exchanged	Additional Notes	IECSA Environments

¹ Note – A triggering event is not necessary if the completion of the prior step – leads to the transition of the following step.

2.1.4 Post-conditions and Significant Results

Describe conditions that must exist at the conclusion of the Function. Identify significant items similar to that in the preconditions section.

Describe any significant results from the Function

<i>Actor/Activity</i>	<i>Post-conditions Description and Results</i>

2.2 Architectural Issues in Interactions

Elaborate on all architectural issues in each of the steps outlined in each of the sequences above. Reference the Step by number..

2.3 Diagram

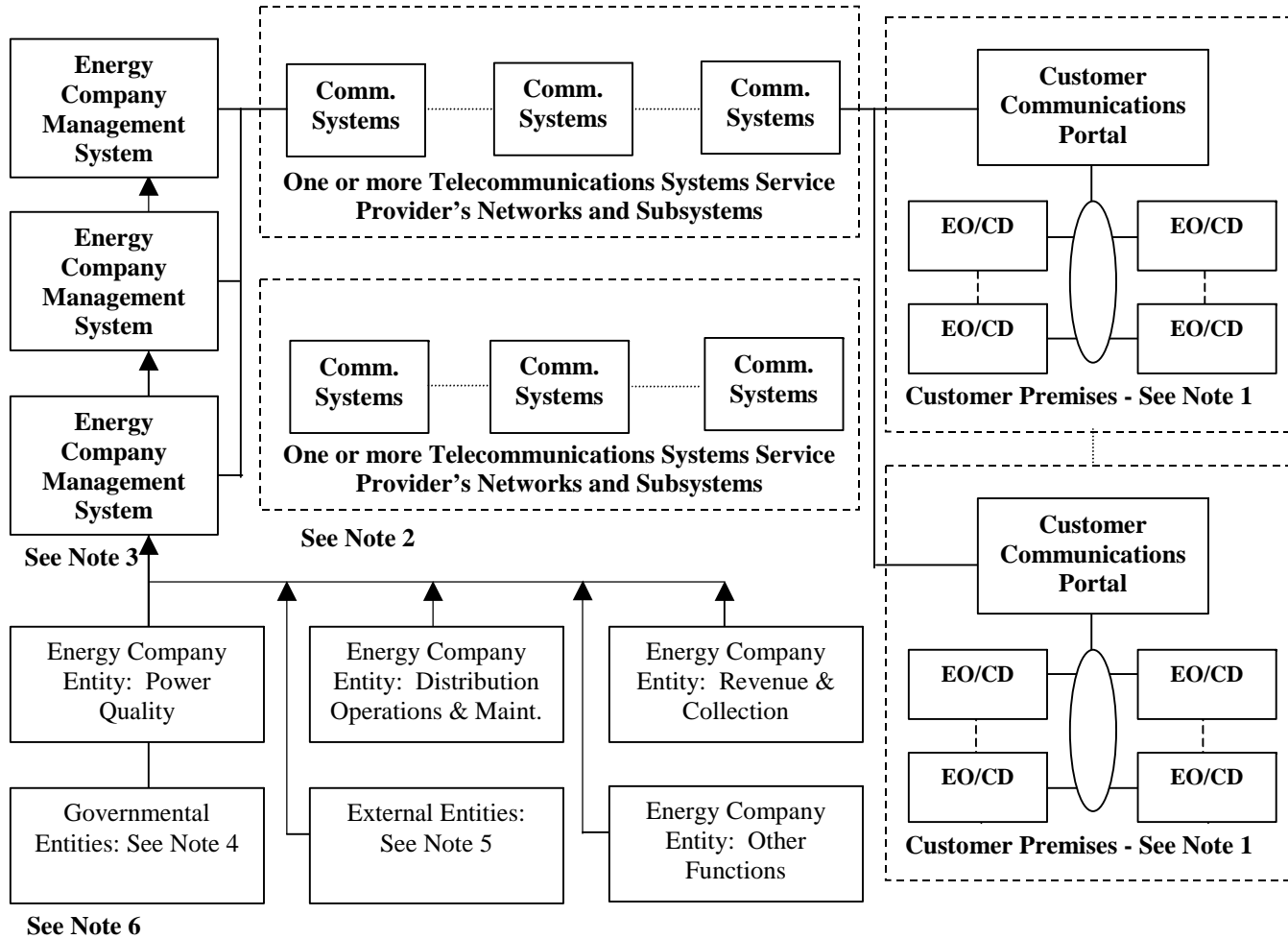

Legend:

EO/CD Energy Company Observable/Controllable Devices
(Systems, Hardware, Software, Applications, etc.)

Notes:

1. EO/CD's may be interconnected to the Customer Communications Portal by various LANs or wired/wireless systems
2. Many diverse Telecommunications Access Networks may be used to connect to Portals
3. Several different Energy Management Systems may be required including an overall "System Manager" (that deals with overall policies, views of various business entities, etc.) a Security Management System (that deals with authorization, security, reporting and related issues) and a Network Management System (that deals with the Customer Portal Access Networks and data communications issues)
4. Several Governmental Entities will need to access certain information that will be obtained via the Customer Communications Portals. Some of these are: PUC's, FERC, FTC, FCC, FBI, DHS, NIST, various State and Local Governmental Agencies, etc.
5. Several Entities outside of the Energy Companies will need to access certain information that will be obtained via the Customer Communications Portals. Some of these are: ISO, RTO, Independent Power Generators, various appliance manufacturers, etc
6. All of the Entities shown in the boxes are routed through the various Key Management Systems. This is meant to signify that the policies, procedures, access control rights, security and other enablers and constraints of these Management Systems will tailor the views of the data that these entities can access and the control messages that they are authorized to initiate. This does not imply that there will actually be individual computer/software systems that these entities must be routed through. The diagram represents a logical view , not a physical view.

3 Auxiliary Issues

3.1 References and contacts

Documents and individuals or organizations used as background to the function described; other functions referenced by this function, or acting as "sub" functions; or other documentation that clarifies the requirements or activities described. All prior work (intellectual property of the company or individual) or proprietary (non-publicly available) work must be so noted.

ID	Title or contact	Reference or contact information
[1]		

[2]		
-----	--	--

3.2 Action Item List

As the function is developed, identify issues that still need clarification, resolution, or other notice taken of them. This can act as an Action Item list.

ID	Description	Status
[1]		
[2]		

3.3 Revision History

For reference and tracking purposes, indicate who worked on describing this function, and what aspect they undertook.

No	Date	Author	Description
0.			

This page intentionally left blank.

Customer Communications Portal Management – System Issues

1 Descriptions of Function

Issues confronting an Energy Company's Management Systems responsible for management of Telecommunications and Access Networks to support Customer Communications Portals.

1.1 Function Name

Customer Communications Portal Management – System Issues

1.2 Function ID

IECSA identification number of the function

C-2.2

1.3 Brief Description

This scenario attempts to describe key issues relevant to the operation of Management Systems in a large Energy Company (Electric and/or Gas and/or Water with several million customers) that provide access to information from and access to control devices located at customer sites. Access to information from devices and access to control one or more devices on the customer premises is provided via Customer Communications Portals.

Here, we focus on system management issues.

1.4 Narrative

The management of many facets of obtaining data from and sending commands or sending data to the Customer Communications Portals/Devices is a necessary and very important undertaking from a data protection, access control, security and network management perspective. There are several key elements that must be managed; issues and assumptions for these diverse areas will be covered separately. The first area to be covered will be System Management, the second Network Management and lastly, Security

Management. There are no assumptions made as to how these management systems will be implemented; there may be one, two, three or many separate computing systems or many distributed systems to accomplish these management tasks. What is important is that the principal issues are identified and that essential tasks are defined well enough to understand what must be done to manage the Customer Communications Portals and the access networks.

System Management functions are functions that deal with the highest-level issues that are required in order to effectively manage the Customer Communications Portals and the access networks. Many of these functions are critical, e.g., addressing of all Customer Communications Portals, devices supported by the portals and indeed every access network system, subsystem or functional element. The ability to access any of these devices is necessary in order to be able to communicate with the device as to its status, to obtain stored data, to download software upgrades and patches, to change set points, read registers, etc. Without a unique address for each device this becomes a very difficult task, if not unmanageable task. It would seem on the surface that unique addresses would be supplied by vendors of these products, however, many vendors have proprietary addressing schemes, or feel that addresses should be unique only on sub networks, i.e., replicate addresses for different networks, etc. Thus one of the first critical steps that need to be taken by a System Manger is to ensure that there are indeed unique addresses for every element of the Customer Communications Portal and access network that requires any form of intercommunications.

In order to support the many users of data within the Energy company as well as Customers and external entities, regulators and Governmental entities many different computer applications will be employed in the gathering of data, management of data and applications that provide needed functionality in the Customer Portals and Devices. Many of these applications will be written and supported by the Energy Company, others will be commercially available applications, and third parties will develop others. In all of these cases it is essential from an operational perspective to ensure that applications are functioning correctly, have the latest revisions running, are up to date in terms of security and other patches and are accessible only by business entities, other applications and individuals authorized to utilize them.

A key function that is needed to ensure efficient operation of a large distributed network such as the Customer Communications Portal network is the use of a common digital clock. The clock should be referenced to a highly stable and accurate clock such as ones maintained and operated by the National Institute of Standards and Technology (NIST). This will ensure that each Portal and Device is synchronized to an accurate time reference and enable any event occurring (equipment fault, alarm, component switching, etc) on the network to be accurately logged and any command issued to a Portal/Device to be accurately time stamped. This is also necessary as a means of analyzing data from many devices on the network to investigate operational anomalies and for resolving complex maintenance problems that might occur.

In addition to the utilization of a common clock there is a clear need for identifying the location of each Portal, Devices and key Communications Access systems and subsystems. Indeed there are many Energy Company applications (such as Customer Information Systems [CIS], and Geographic Information Systems [GIS]) that have location information by customer, some electrical elements (such as distribution transformers) etc. Other Energy company systems, including Outage Detection / Service Restoral Systems, may in fact make use of some CIS or GIS information to aid in the rapid location of outages so that service may be restored quickly. Given that Customer Communications Portals may be extensively deployed, it is essential that a universal means of defining locations of the portals, devices and key communications systems components be developed that can be utilized for Customer Portal identification and applications serving them and which can also be applied to existing applications such as CIS and GIS.

- 1) Addressing of all Customer Communications Portals, EO/CDs and Communications Systems observable and controllable elements, applications and management entities must be unique and identified in a consistent manner
- 2) Management Integration: Since there will be many different types of communications systems and subsystems used to interconnect the Energy Company to Customer Communications Portals, there will be many different Network Management Systems used by the Communications service providers. It is critical that the “Energy Company Management Systems” be capable of communicating and interacting with the Communications Service provider Network Management Systems and especially with their “Network users management application entity” (software in communications subsystems and devices providing network management services) in a consistent manner¹.
- 3) Use of a consistent clock that is referenced to a primary time source. It is absolutely critical that all communications systems, subsystems, Customer Communications Portals and customer premises devices be linked to this clock.
 - a) All transactions, communications messages, alarms, control actions, network management system messages and control actions must be time stamped
 - b) Different levels of time synchronization with consumer and energy systems may need to be established depending on the requirements of the applications. Categories may include the definition of operating environments linked to time management requirements. Possible categories include:
 - i) “X” time range at the remote device (Tight Phasor Measurement Quality). The exact deviation from the reference clock will be determined by the requirements of the particular device. For example, measuring phase differences of a Transmission Line voltage or current at two different locations for protection purposes will require the highest level of synchronization with respect to a reference clock.
 - ii) “Y” time range at the remote device (PQ event Measurement Quality).
 - iii) “Z” time range at the remote device (Transaction Management Quality)

¹ Service providers Network Management Systems will not allow users to directly access and control their various systems and subsystems, but they will generally enable large users to access information from their systems and many cases their subsystems. As generally the protocols used in these Network Management Systems (especially the protocols used to interconnect to subsystems and devices in the communications network) are proprietary, substantial effort will be required to adequately implement Energy Company access to service provider telecommunications networks in a consistent manner.

- iv) “V” Other
- 4) All transactions, communications messages, alarms, control actions, network management system messages and control actions must be logged
 - a) Since several diverse Energy Company Management Systems may be used to manage different aspects of communicating with Customer Communications Portals (e.g., Energy Conservation/Load Control Systems, Telecommunications Network Management System, Security Management System, etc) “log data” from diverse logging systems must be either merged, or applications developed to intelligently audit and manage various data sent to or received from the Customer Communications Portals and/or the various telecommunications networks used to connect with the Portals.
- 5) The location of all Customer Communications Portals (and for major customers, critical devices), critical communications system components and subsystems must be uniquely identified.
 - a) The method used to identify the location of the Customer Communications Portals, communications systems and devices must be compatible with or easily mapped to the method used by Energy Company
 - i) Geographical Information Systems.
 - ii) Customer Information Systems
 - iii) Outage Detection and Work Management Systems
 - iv) Transmission (electric and gas) and Distribution (electric and gas) SCADA Systems

1.5 Actor (Stakeholder) Roles

Describe all the people (their job), systems, databases, organizations, and devices involved in or affected by the Function (e.g. operators, system administrators, technicians, end users, service personnel, executives, SCADA system, real-time database, RTO, RTU, IED, power system). Typically, these actors are logically grouped by organization or functional boundaries or just for collaboration purpose of this use case. We need to identify these groupings and their relevant roles and understand the constituency. The same actor could play different roles in different Functions, but only one role in one Function. If the same actor (e.g. the same person) does play multiple roles in one Function, list these different actor-roles as separate rows.

<i>Grouping (Community)</i>		<i>Group Description</i>
<i>Actor Name</i>	<i>Actor Type (person, device, system etc.)</i>	<i>Actor Description</i>

<i>Grouping (Community)</i>		<i>Group Description</i>
<i>Actor Name</i>	<i>Actor Type (person, device, system etc.)</i>	<i>Actor Description</i>

Replicate this table for each logic group.

1.6 Information exchanged

Describe any information exchanged in this template.

<i>Information Object Name</i>	<i>Information Object Description</i>

1.7 Activities/Services

Describe or list the activities and services involved in this Function (in the context of this Function). An activity or service can be provided by a computer system, a set of applications, or manual procedures. These activities/services should be described at an appropriate level, with the understanding that sub-activities and services should be described if they are important for operational issues, automation needs, and implementation reasons. Other sub-activities/services could be left for later analysis.

<i>Activity/Service Name</i>	<i>Activities/Services Provided</i>

<i>Activity/Service Name</i>	<i>Activities/Services Provided</i>

1.8 Contracts/Regulations

Identify any overall (human-initiated) contracts, regulations, policies, financial considerations, engineering constraints, pollution constraints, and other environmental quality issues that affect the design and requirements of the Function.

<i>Contract/Regulation</i>	<i>Impact of Contract/Regulation on Function</i>

<i>Policy</i>	<i>From Actor</i>	<i>May</i>	<i>Shall Not</i>	<i>Shall</i>	<i>Description (verb)</i>	<i>To Actor</i>

<i>Constraint</i>	<i>Type</i>	<i>Description</i>	<i>Applies to</i>

2 Step by Step Analysis of Function

Describe steps that implement the function. If there is more than one set of steps that are relevant, make a copy of the following section grouping (Preconditions and Assumptions, Steps normal sequence, and Steps alternate or exceptional sequence, Post conditions)

2.1 Steps to implement function

Name of this sequence.

2.1.1 Preconditions and Assumptions

Describe conditions that must exist prior to the initiation of the Function, such as prior state of the actors and activities

Identify any assumptions, such as what systems already exist, what contractual relations exist, and what configurations of systems are probably in place

Identify any initial states of information exchanged in the steps in the next section. For example, if a purchase order is exchanged in an activity, its precondition to the activity might be 'filled in but unapproved'.

<i>Actor/System/Information/Contract</i>	<i>Preconditions or Assumptions</i>

2.1.2 Steps – Normal Sequence

Describe the normal sequence of events, focusing on steps that identify new types of information or new information exchanges or new interface issues to address. Should the sequence require detailed steps that are also used by other functions, consider creating a new “sub” function, then referring to that “subroutine” in this function. Remember that the focus should be less on the algorithms of the applications and more on the interactions and information flows between “entities”, e.g. people, systems, applications, data bases, etc. There should be a direct link between the narrative and these steps.

The numbering of the sequence steps conveys the order and concurrency and iteration of the steps occur. Using a Dewey Decimal scheme, each level of nested procedure call is separated by a dot ‘.’. Within a level, the sequence number comprises an optional letter and an integer number. The letter specifies a concurrent sequence within the next higher level; all letter sequences are concurrent with other letter sequences. The number specifies the sequencing of messages in a given letter sequence. The absence of a letter is treated as a default ‘main sequence’ in parallel with the lettered sequences.

Sequence 1:

*1.1 - Do step 1
1.2A.1 - In parallel to activity 2 B do step 1
1.2A.2 - In parallel to activity 2 B do step 2
1.2B.1 - In parallel to activity 2 A do step 1
1.2B.2 - In parallel to activity 2 A do step 2
1.3 - Do step 3
1.3.1 - nested step 3.1
1.3.2 - nested step 3.2*

Sequence 2:

*2.1 - Do step 1
2.2 - Do step 2*

#	Event	Primary Actor	Name of Process/Activity	Description of Process/Activity	Information Producer	Information Receiver	Name of Info Exchanged	Additional Notes	IECSA Environments
#	<i>Triggering event? Identify the name of the event.²</i>	<i>What other actors are primarily responsible for the Process/Activity? Actors are defined in section0.</i>	<i>Label that would appear in a process diagram. Use action verbs when naming activity.</i>	<i>Describe the actions that take place in active and present tense. The step should be a descriptive noun/verb phrase that portrays an outline summary of the step. "If ...Then...Else" scenarios can be captured as multiple Actions or as separate steps.</i>	<i>What other actors are primarily responsible for Producing the information? Actors are defined in section0.</i>	<i>What other actors are primarily responsible for Receiving the information? Actors are defined in section0. (Note – May leave blank if same as Primary Actor)</i>	<i>Name of the information object. Information objects are defined in section 1.6</i>	<i>Elaborate architectural issues using attached spreadsheet. Use this column to elaborate details that aren't captured in the spreadsheet.</i>	<i>Reference the applicable IECSA Environment containing this data exchange. Only one environment per step.</i>

2.1.3 Steps – Alternative / Exception Sequences

Describe any alternative or exception sequences that may be required that deviate from the normal course of activities. Note instructions are found in previous table.

#	Event	Primary Actor	Name of Process/Activity	Description of Process/Activity	Information Producer	Information Receiver	Name of Info Exchanged	Additional Notes	IECSA Environments

² Note – A triggering event is not necessary if the completion of the prior step – leads to the transition of the following step.

2.1.4 Post-conditions and Significant Results

Describe conditions that must exist at the conclusion of the Function. Identify significant items similar to that in the preconditions section.

Describe any significant results from the Function

<i>Actor/Activity</i>	<i>Post-conditions Description and Results</i>

2.2 Architectural Issues in Interactions

Elaborate on all architectural issues in each of the steps outlined in each of the sequences above. Reference the Step by number..

2.3 Diagram

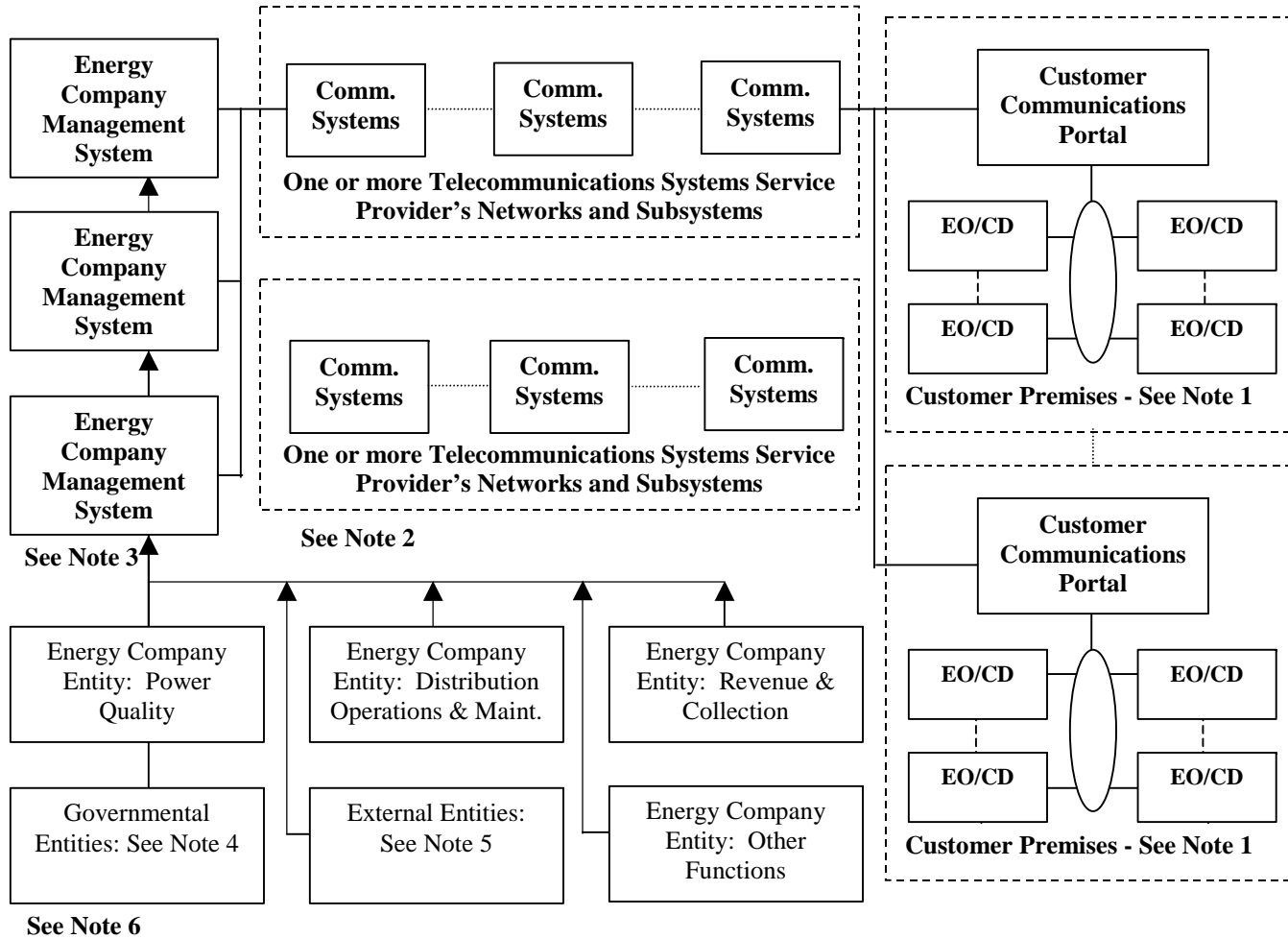

Legend:

EO/CD Energy Company Observable/Controllable Devices
(Systems, Hardware, Software, Applications, etc.)

Notes:

1. EO/CD's may be interconnected to the Customer Communications Portal by various LANs or wired/wireless systems
2. Many diverse Telecommunications Access Networks may be used to connect to Portals
3. Several different Energy Management Systems may be required including an overall "System Manager" (that deals with overall policies, views of various business entities, etc.) a Security Management System (that deals with authorization, security, reporting and related issues) and a Network Management System (that deals with the Customer Portal Access Networks and data communications issues)
4. Several Governmental Entities will need to access certain information that will be obtained via the Customer Communications Portals. Some of these are: PUC's, FERC, FTC, FCC, FBI, DHS, NIST, various State and Local Governmental Agencies, etc.
5. Several Entities outside of the Energy Companies will need to access certain information that will be obtained via the Customer Communications Portals. Some of these are: ISO, RTO, Independent Power Generators, various appliance manufacturers, etc
6. All of the Entities shown in the boxes are routed through the various Key Management Systems. This is meant to signify that the policies, procedures, access control rights, security and other enablers and constraints of these Management Systems will tailor the views of the data that these entities can access and the control messages that they are authorized to initiate. This does not imply that there will actually be individual computer/software systems that these entities must be routed through. The diagram represents a logical view , not a physical view.

3 Auxiliary Issues

3.1 References and contacts

Documents and individuals or organizations used as background to the function described; other functions referenced by this function, or acting as "sub" functions; or other documentation that clarifies the requirements or activities described. All prior work (intellectual property of the company or individual) or proprietary (non-publicly available) work must be so noted.

ID	Title or contact	Reference or contact information
[1]		

[2]		
-----	--	--

3.2 Action Item List

As the function is developed, identify issues that still need clarification, resolution, or other notice taken of them. This can act as an Action Item list.

ID	Description	Status
[1]		
[2]		

3.3 Revision History

For reference and tracking purposes, indicate who worked on describing this function, and what aspect they undertook.

No	Date	Author	Description
0.			

Customer Communications Portal Management – Telecommunications Issues

1 Descriptions of Function

Issues confronting an Energy Company's Management Systems responsible for management of Telecommunications and Access Networks to support Customer Communications Portals.

1.1 Function Name

Customer Communications Portal Management – Telecommunications issues

1.2 Function ID

IECSA identification number of the function

C-4

1.3 Brief Description

This scenario attempts to describe key issues relevant to the operation of Management Systems in a large Energy Company (Electric and/or Gas and/or Water with several million customers) that provide access to information from and access to control devices located at customer sites. Access to information from devices and access to control one or more devices on the customer premises is provided via Customer Communications Portals.

Here, we focus on telecommunications issues.

1.4 Narrative

Many Energy companies have extensive internal telecommunications networks, leased telecommunications systems and the Internet, which are utilized for a variety of operational and administrative business purposes. The extensive deployment of Customer Communications Portals will significantly expand telecommunications networking use and thus both existing and new networks must be effectively managed to ensure that they meet the needs of the Customer Communications Portal applications, external entities requiring access to specific customer data and the Energy Company and its customers. Many existing telecommunications networks utilized have their own proprietary management systems, which are specific to their domain. As the complexity of the networks

grow, a more integrated approach is required that can utilize information from many diverse sources including the existing and new Customer Communications Portals and associated access networks as well as information from components and systems utilizing the internet.

There are several key components that are required in order to ensure effective management of networking systems and attached components; knowledge of applications that are utilized by Customer Communications Portals and associated devices, access network performance and operational metrics (data traffic patterns, usage by application, network anomalies, performance degradation, etc.) usage patterns of the users that make use of the data obtained along with many other components. Specific attributes of the applications must be known in order to ascertain if it is being used by individuals or other applications authorized to utilize it. In addition the type of transactions that are being performed by the application must be known so that the type of traffic expected can be supported. The usage patterns of many diverse users and applications must also be known on a statistical basis in order to ensure that the network is adequately configured to support the traffic and the response times needed by the applications and users.

Privacy needs of business entities, Governmental Agencies, Regulatory Agencies, Energy Company users and other users of the retrieved data and resources of the telecommunications access network must be assured. In order to satisfy these needs several issues must be addressed in the Telecommunications Network Management System; The policies determined by the various business entities for access control and security must be clearly identified and recognized by the Telecommunications Network Management System (TNMS) (this does not mean that the TNMS will implement these policies, but that it is aware of these policies and that the policies are taken into account in the operational configuration of the networks and that the TNMS will be aware of any breach of the policies and log any discrepancies, provide alarms of any breach and take corrective actions if possible.

In order to manage the operational aspects of the Customer Communications Portal, devices and Access Networks tools will be part of the TNMS to monitor the network for health, performance, availability and its capability to meet service level agreements negotiated with the various users of the network. These tools will also provide data, which can be used by management to ensure rapid reconfiguration of Access Network resources to restore service during any disruptions and to reconfigure network resources as needed to meet user needs. These tools are indispensable in the current business and technical networking environment where human resources are limited and near perfect reliability and availability of the network is almost a given.

- 1) Every application supported or enabled by the Customer Communications Portal and Energy Company Computer systems communicating with the Portals must be formally identified and recognized by the Network Management System
 - a) The purpose of the application and what it is intended to accomplish must be clearly identified and recognized by the Network Management System
 - b) The Status of the application and the version release must be recognized
 - c) The type of data communications required by each application must be recognized, i.e.,
 - i) Retrieval of batch data,
 - ii) Interactive inquiry/response data,
 - iii) Downloading of application updates to Portals and Devices
 - d) The Energy Company and other (Government, ISO/RTO's and various regulatory bodies) users of the data must be clearly identified and recognized

- 2) The overall data load must be recognized by the Network Management System for each application, including:
 - i) Average data uploaded from each Portal
 - ii) Average data download to each Portal
 - iii) Peak data load in each direction
 - iv) The number of transactions per day, hour, etc
 - v) The transaction message size in bytes in each direction
- 3) The privacy and security requirements for each application must be identified and recognized by the Network Management System. Note this does not imply that the Network Management System will have the capability to set or change any security or privacy settings or levels, only that the Network Management System knows what the application and user security requirements are.
 - a) The location of each Portal and supported devices that make use of each application must be known so that the topology of the various system components on an application basis is recognized
- 4) Service Level data must be collected and logged, by application and by user in order to ensure that service level agreements made with the internal and external users of the data and the Energy Company Customers is maintained. If any significant deviation is revealed by the data obtained controlling actions on the telecommunications access network, or components must be taken (note that some action will take place in an automated basis, but in other cases design changes must be undertaken)
- 5) Continuous data relative to the health of the network components must be obtained from each major element of the telecommunications access network in order to ensure that any downtime of the network or of sub network components is kept to a minimum. This is also necessary in order to ensure that problem resolution activities are quickly implemented and escalation of problems is kept to a minimum
 - a) Diagnostic tools will be an integral part of the Network Management System in order to support the problem determination portion of the system and to help evaluate the statistics obtained from the network
 - b) Preventative maintenance procedure development will be based on evaluation of data obtained
- 6) Network testing must be executed on a regularly scheduled basis to ensure that each major component of the telecommunications network is functioning properly and within design parameters (even though alarm systems will notify the Network Management System of component failures partial failures or performance degradations may not trigger alarms).

- 7) Network recovery procedures must be in place to ensure that any telecommunications access network failures will not impact receipt of data from the Customer Communications Portals and associated devices.
 - a) Note that this function must be performed in an automated fashion and must be consistent with the need as defined by the application and service level agreements made with the users and Energy Company customers.
- 8) Configuration management procedures will be enabled in order to:
 - i) Maintain the proper service level agreements by application, users and customers
 - ii) Appropriate utilization of telecommunications network access resources
 - iii) Ensure that alternate routing is available for critical services
 - iv) Defective components are bypassed
- 9) Telecommunication Access Network, Customer Communications Portal and Customer Device activation, deactivation and connection set up tools will be an integral component of the Network Management System

1.5 Actor (Stakeholder) Roles

Describe all the people (their job), systems, databases, organizations, and devices involved in or affected by the Function (e.g. operators, system administrators, technicians, end users, service personnel, executives, SCADA system, real-time database, RTO, RTU, IED, power system). Typically, these actors are logically grouped by organization or functional boundaries or just for collaboration purpose of this use case. We need to identify these groupings and their relevant roles and understand the constituency. The same actor could play different roles in different Functions, but only one role in one Function. If the same actor (e.g. the same person) does play multiple roles in one Function, list these different actor-roles as separate rows.

<i>Grouping (Community)</i>		<i>Group Description</i>
<i>Actor Name</i>	<i>Actor Type (person, device, system etc.)</i>	<i>Actor Description</i>

<i>Grouping (Community)</i>		<i>Group Description</i>
<i>Actor Name</i>	<i>Actor Type (person, device, system etc.)</i>	<i>Actor Description</i>

Replicate this table for each logic group.

1.6 Information exchanged

Describe any information exchanged in this template.

<i>Information Object Name</i>	<i>Information Object Description</i>

1.7 Activities/Services

Describe or list the activities and services involved in this Function (in the context of this Function). An activity or service can be provided by a computer system, a set of applications, or manual procedures. These activities/services should be described at an appropriate level, with the understanding that sub-activities and services should be described if they are important for operational issues, automation needs, and implementation reasons. Other sub-activities/services could be left for later analysis.

<i>Activity/Service Name</i>	<i>Activities/Services Provided</i>

<i>Activity/Service Name</i>	<i>Activities/Services Provided</i>

1.8 Contracts/Regulations

Identify any overall (human-initiated) contracts, regulations, policies, financial considerations, engineering constraints, pollution constraints, and other environmental quality issues that affect the design and requirements of the Function.

<i>Contract/Regulation</i>	<i>Impact of Contract/Regulation on Function</i>

<i>Policy</i>	<i>From Actor</i>	<i>May</i>	<i>Shall Not</i>	<i>Shall</i>	<i>Description (verb)</i>	<i>To Actor</i>

<i>Constraint</i>	<i>Type</i>	<i>Description</i>	<i>Applies to</i>

2 Step by Step Analysis of Function

Describe steps that implement the function. If there is more than one set of steps that are relevant, make a copy of the following section grouping (Preconditions and Assumptions, Steps normal sequence, and Steps alternate or exceptional sequence, Post conditions)

2.1 Steps to implement function

Name of this sequence.

2.1.1 Preconditions and Assumptions

Describe conditions that must exist prior to the initiation of the Function, such as prior state of the actors and activities

Identify any assumptions, such as what systems already exist, what contractual relations exist, and what configurations of systems are probably in place

Identify any initial states of information exchanged in the steps in the next section. For example, if a purchase order is exchanged in an activity, its precondition to the activity might be 'filled in but unapproved'.

<i>Actor/System/Information/Contract</i>	<i>Preconditions or Assumptions</i>

2.1.2 Steps – Normal Sequence

Describe the normal sequence of events, focusing on steps that identify new types of information or new information exchanges or new interface issues to address. Should the sequence require detailed steps that are also used by other functions, consider creating a new “sub” function, then referring to that “subroutine” in this function. Remember that the focus should be less on the algorithms of the applications and more on the interactions and information flows between “entities”, e.g. people, systems, applications, data bases, etc. There should be a direct link between the narrative and these steps.

The numbering of the sequence steps conveys the order and concurrency and iteration of the steps occur. Using a Dewey Decimal scheme, each level of nested procedure call is separated by a dot ‘.’. Within a level, the sequence number comprises an optional letter and an integer number. The letter specifies a concurrent sequence within the next higher level; all letter sequences are concurrent with other letter sequences. The number specifies the sequencing of messages in a given letter sequence. The absence of a letter is treated as a default ‘main sequence’ in parallel with the lettered sequences.

Sequence 1:

*1.1 - Do step 1
1.2A.1 - In parallel to activity 2 B do step 1
1.2A.2 - In parallel to activity 2 B do step 2
1.2B.1 - In parallel to activity 2 A do step 1
1.2B.2 - In parallel to activity 2 A do step 2
1.3 - Do step 3
1.3.1 - nested step 3.1
1.3.2 - nested step 3.2*

Sequence 2:

*2.1 - Do step 1
2.2 - Do step 2*

#	Event	Primary Actor	Name of Process/Activity	Description of Process/Activity	Information Producer	Information Receiver	Name of Info Exchanged	Additional Notes	IECSA Environments
#	<i>Triggering event? Identify the name of the event.¹</i>	<i>What other actors are primarily responsible for the Process/Activity? Actors are defined in section0.</i>	<i>Label that would appear in a process diagram. Use action verbs when naming activity.</i>	<i>Describe the actions that take place in active and present tense. The step should be a descriptive noun/verb phrase that portrays an outline summary of the step. "If ...Then...Else" scenarios can be captured as multiple Actions or as separate steps.</i>	<i>What other actors are primarily responsible for Producing the information? Actors are defined in section0.</i>	<i>What other actors are primarily responsible for Receiving the information? Actors are defined in section0. (Note – May leave blank if same as Primary Actor)</i>	<i>Name of the information object. Information objects are defined in section 1.6</i>	<i>Elaborate architectural issues using attached spreadsheet. Use this column to elaborate details that aren't captured in the spreadsheet.</i>	<i>Reference the applicable IECSA Environment containing this data exchange. Only one environment per step.</i>

2.1.3 Steps – Alternative / Exception Sequences

Describe any alternative or exception sequences that may be required that deviate from the normal course of activities. Note instructions are found in previous table.

#	Event	Primary Actor	Name of Process/Activity	Description of Process/Activity	Information Producer	Information Receiver	Name of Info Exchanged	Additional Notes	IECSA Environments

¹ Note – A triggering event is not necessary if the completion of the prior step – leads to the transition of the following step.

2.1.4 Post-conditions and Significant Results

Describe conditions that must exist at the conclusion of the Function. Identify significant items similar to that in the preconditions section.

Describe any significant results from the Function

<i>Actor/Activity</i>	<i>Post-conditions Description and Results</i>

2.2 Architectural Issues in Interactions

Elaborate on all architectural issues in each of the steps outlined in each of the sequences above. Reference the Step by number..

2.3 Diagram

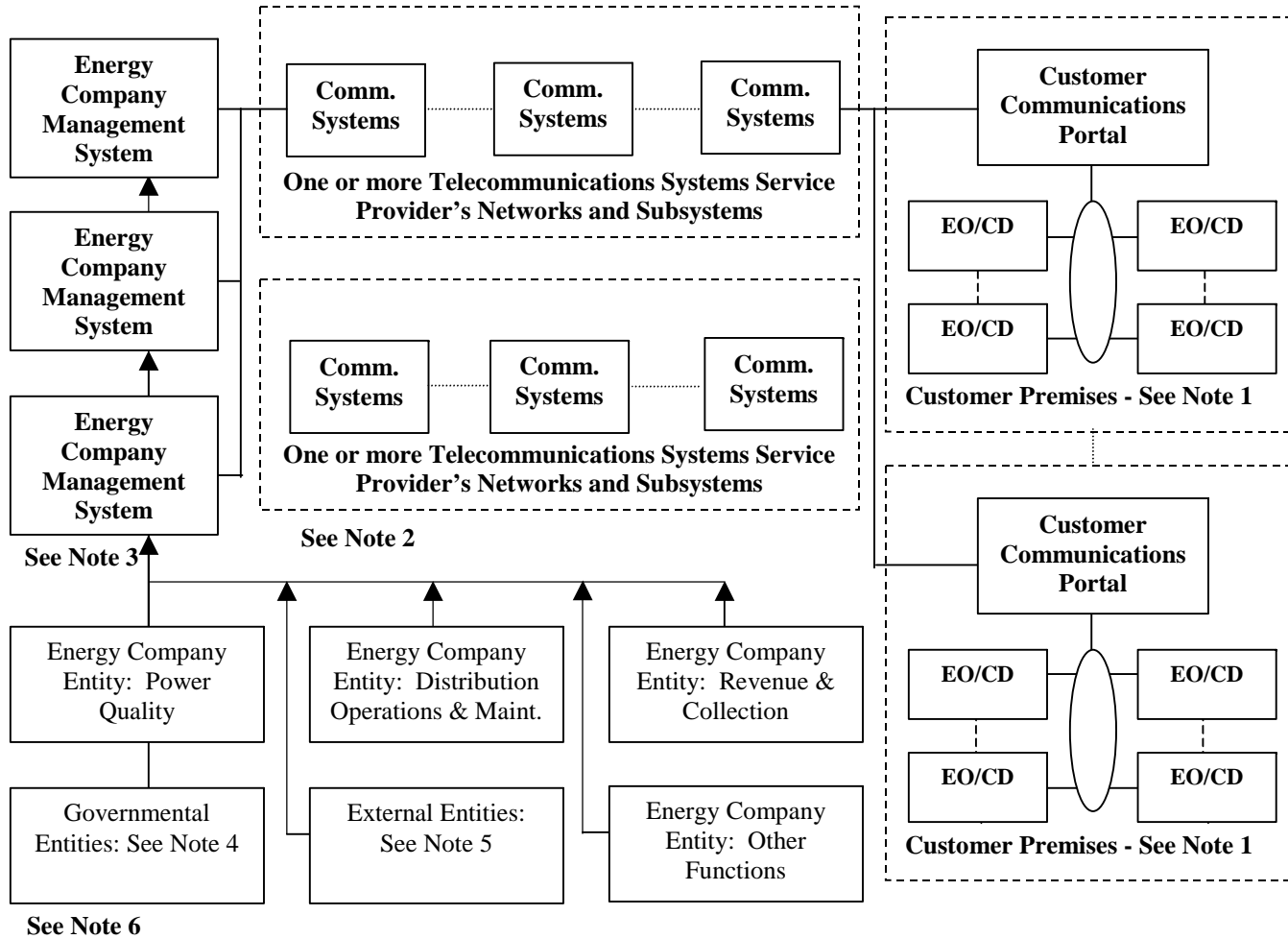

Legend:

EO/CD Energy Company Observable/Controllable Devices
(Systems, Hardware, Software, Applications, etc.)

Notes:

1. EO/CD's may be interconnected to the Customer Communications Portal by various LANs or wired/wireless systems
2. Many diverse Telecommunications Access Networks may be used to connect to Portals
3. Several different Energy Management Systems may be required including an overall "System Manager" (that deals with overall policies, views of various business entities, etc.) a Security Management System (that deals with authorization, security, reporting and related issues) and a Network Management System (that deals with the Customer Portal Access Networks and data communications issues)
4. Several Governmental Entities will need to access certain information that will be obtained via the Customer Communications Portals. Some of these are: PUC's, FERC, FTC, FCC, FBI, DHS, NIST, various State and Local Governmental Agencies, etc.
5. Several Entities outside of the Energy Companies will need to access certain information that will be obtained via the Customer Communications Portals. Some of these are: ISO, RTO, Independent Power Generators, various appliance manufacturers, etc
6. All of the Entities shown in the boxes are routed through the various Key Management Systems. This is meant to signify that the policies, procedures, access control rights, security and other enablers and constraints of these Management Systems will tailor the views of the data that these entities can access and the control messages that they are authorized to initiate. This does not imply that there will actually be individual computer/software systems that these entities must be routed through. The diagram represents a logical view , not a physical view.

3 Auxiliary Issues

3.1 References and contacts

Documents and individuals or organizations used as background to the function described; other functions referenced by this function, or acting as "sub" functions; or other documentation that clarifies the requirements or activities described. All prior work (intellectual property of the company or individual) or proprietary (non-publicly available) work must be so noted.

ID	Title or contact	Reference or contact information
[1]		

[2]		
-----	--	--

3.2 Action Item List

As the function is developed, identify issues that still need clarification, resolution, or other notice taken of them. This can act as an Action Item list.

ID	Description	Status
[1]		
[2]		

3.3 Revision History

For reference and tracking purposes, indicate who worked on describing this function, and what aspect they undertook.

No	Date	Author	Description
0.			

Consumer Portal Scenario P4 Customer Account Move

1 Descriptions of Function

All prior work (intellectual property of the company or individual) or proprietary (non-publicly available) work should be so noted.

1.1 Function Name

Name of Function: Customer account move

1.2 Function ID

IECSA identification number of the function

C-2.2

1.3 Brief Description

Describe briefly the scope, objectives, and rationale of the Function

An existing customer wants to close out his existing account and transfer that to his new residence, along with all applicable utility service and billing account information. This transfer is to be accomplished as an one-stop service in which the customer makes one call to the power company whose service representative handles all of the actions.

1.4 Narrative

A complete narrative of the Function from a Domain Expert's point of view, describing what occurs when, why, how, and under what conditions. This will be a separate document, but will act as the basis for identifying the Steps in Section 2.

A western utility has a residential customer base of 1 million meters. The meters are installed in single-family detached housing (SFD), single-family attached housing (SFA), apartment buildings and mobile homes. The utility has a high residential turnover rate as customers come to and leave the service area more frequently than typical utilities.

The utility has demand relief requirements and has multiple demand response programs in place. It additionally supports active residential conservation programs as well as residential alternate, renewable and distributed generation.

The results of all of these efforts are reported to the Sate PUC as part of their requirements to receive credit in rate base.

On Monday morning a residential customer of utility X calls Customer Service and requests that their power be turned off because they are moving from their SFD home in the suburbs to a condo in town. They want to simplify their lives. They advise the utility that they already have the condo purchased and wondered if they could transfer their utility bill to the new address and pay on the same monthly schedule as they now have. They also ask if the electric utility can facilitate the shut-off and/or transfer of all of their utilities including gas, water, trash collection, cable TV service and telephone.

The progressive utility assures the customer that they can provide one-stop service and in fact can take care of everything. The Customer Service representative (CSR) calls up the customer's account information and forwards the entire request, along with the information to a "relocation specialist" (RS) while the customer is still on the line. The relocation specialist opens up a regional web-hosted database and using the electric utility's identification number, calls up all utility services that the client has signed up for. By placing in the moving data and relocation information, the database software automatically notifies all other utilities of the pending move. Each utility can then provide final billing information on the old residence and set up the services at the new residence. The residential customer receives a transaction report, much like a stock market purchase/sell order, that identifies all utilities, all accounts, dates and transitions the customer to a new residence and sets up new account information. The transition invoice lists services provided up to the transition date as cost "X" and starts new billing information (on the same monthly invoice) that delineates costs for services provided at the new residence for the remaining days of the month.

The residential customer moves to the new home and all utilities are in service and they receive a monthly invoice at the usual time that includes old house and new house billing information. The process is seamless, transparent to the customer, and of value to the utilities involved.

1.5 Actor (Stakeholder) Roles

Describe all the people (their job), systems, databases, organizations, and devices involved in or affected by the Function (e.g. operators, system administrators, technicians, end users, service personnel, executives, SCADA system, real-time database, RTO, RTU, IED, power system). Typically, these actors are logically grouped by organization or functional boundaries or just for collaboration purpose of this use case. We need to identify these groupings and their relevant roles and understand the constituency. The same actor could play different roles in different Functions, but only one role in one Function. If the same actor (e.g. the same person) does play multiple roles in one Function, list these different actor-roles as separate rows.

<i>Grouping (Community)'</i>		<i>Group Description</i>
<i>Customer Site</i>		<i>Those entities that are located at customer's premises</i>
<i>Actor Name</i>	<i>Actor Type (person, device, system etc.)</i>	<i>Actor Description</i>
Customer	Person	One requesting the account move.
CustomerCommunicationPortal	System	Device handling communications function at customer's premises

Replicate this table for each logic group.

<i>Grouping (Community)'</i>		<i>Group Description</i>
<i>Power Company Customer Service</i>		<i>Those entities that are charged with handling customer service functions for the power company</i>
<i>Actor Name</i>	<i>Actor Type (person, device, system etc.)</i>	<i>Actor Description</i>
ServiceProviderEnergyServiceProvider	Organizations	Participating power companies and service providers
Power Company	System	Power company communications system that handles customer call center services
CSR	Person	Customer Service Representative (CSR), Person who interfaces with the customer initially for the power company
CRS	Person	Customer Relocation Specialist (CRS), Person who handles relocation-related

<i>Grouping (Community)</i>		<i>Group Description</i>
<i>Power Company Customer Service</i>		<i>Those entities that are charged with handling customer service functions for the power company</i>
<i>Actor Name</i>	<i>Actor Type (person, device, system etc.)</i>	<i>Actor Description</i>
		services for the customer
CustomerInformationDatabase	System	System that contains information about customer accounts of the power company
RegionalCustomerInformationDatabase	System	System that contains information about all of the services related customer accounts [e.g., such as power, gas, water, phone, TV, Internet, etc] keyed to a common customer id
CustomerBillingSystem	System	System that handles generation of bills for the services provided to the customer
CustomerId	Device	A common customer identification key that is used by service providers authorized by the customer to identify all of their service accounts
ServiceConnect-CustomerDisconnectSystem	System	System that handles turning on/off of specific customer services; in this case, it refers to the system for turning on/off power to the customer premises

<i>Grouping (Community)</i>		<i>Group Description</i>
<i>Others</i>		
<i>Actor Name</i>	<i>Actor Type (person, device, system etc.)</i>	<i>Actor Description</i>
Energy Service Provider		
ServiceProvider		

1.6 Information exchanged

Describe any information exchanged in this template.

<i>Information Object Name</i>	<i>Information Object Description</i>
Customer Account Change Request	Signifies that a customer account request call has been received from the customer asking for service for making changes on the account
Account Change	Information on specific changes to be made to the account [in this case, turn off service at current location and turn on services at the new location]
Account Confirmation	Information confirming the changes made to the account based on the customer call

1.7 Activities/Services

Describe or list the activities and services involved in this Function (in the context of this Function). An activity or service can be provided by a computer system, a set of applications, or manual procedures. These activities/services should be described at an appropriate level, with the

understanding that sub-activities and services should be described if they are important for operational issues, automation needs, and implementation reasons. Other sub-activities/services could be left for later analysis.

<i>Activity/Service Name</i>	<i>Activities/Services Provided</i>
Turn Off Current Services	Initiate actions by the service provider[s] to turn off service to the customer’s current location on the date specified by the customer
Generate Final Billing Information	Initiate actions to generate final billing information for the services being turned off
Set Up New Location Account Information	Initiate actions to set up the customer account with the new location information
Transfer Old Account Billing Information to New Account	Initiate actions to transfer the final billing information to the new account for inclusion in the first bill of the new account
Turn On New Location Services	Initiate actions to turn on requested services to the customer’s new location on the date specified by the customer
Generate New Location Billing Information	Initiate actions to generate regular billing to the customer for the services provided at the new location

1.8 Contracts/Regulations

Identify any overall (human-initiated) contracts, regulations, policies, financial considerations, engineering constraints, pollution constraints, and other environmental quality issues that affect the design and requirements of the Function.

<i>Contract/Regulation</i>	<i>Impact of Contract/Regulation on Function</i>
Service Delivery	Turn on/off services delivery to customer

<i>Contract/Regulation</i>		<i>Impact of Contract/Regulation on Function</i>				
<i>Policy</i>	<i>From Actor</i>	<i>May</i>	<i>Shall Not</i>	<i>Shall</i>	<i>Description (verb)</i>	<i>To Actor</i>
Provide Services	ServiceProvider			X	Provide specified service	Customer
Deny Energy	Energy Service Provider		X		Turn off power	Customer
Deny Services	ServiceProvider		X		Turn off specified service	Customer

<i>Constraint</i>	<i>Type</i>	<i>Description</i>	<i>Applies to</i>
<i>Account Status</i>	<i>Active</i>	<i>Customer account at location is active</i>	<i>Delivery of power and services to customer account location</i>
<i>Account Status</i>	<i>Inactive</i>	<i>Customer account at location is inactive</i>	<i>Turn off power and services to customer account location</i>

2 Step by Step Analysis of Function

Describe steps that implement the function. If there is more than one set of steps that are relevant, make a copy of the following section grouping (Preconditions and Assumptions, Steps normal sequence, and Steps alternate or exceptional sequence, Post conditions)

2.1 Steps to implement function

Name of this sequence.

2.1.1 Preconditions and Assumptions

Describe conditions that must exist prior to the initiation of the Function, such as prior state of the actors and activities

Identify any assumptions, such as what systems already exist, what contractual relations exist, and what configurations of systems are probably in place

Identify any initial states of information exchanged in the steps in the next section. For example, if a purchase order is exchanged in an activity, its precondition to the activity might be 'filled in but unapproved'.

<i>Actor/System/Information/Contract</i>	<i>Preconditions or Assumptions</i>
Customer id	Assumes that a common customer id is used by all service providers
Common customer services database	Assumes that an integrated regional database exists that contains information about all services provided to the customer keyed to the common customer id
Service delivery contract	Assumes that a service contract exists that permits the utility company to make changes to customer service delivery, accounts and billing information
CustomerCommunicationPortal	Assumes that the CustomerCommunicationPortal is installed in the customer location that will permit final meter reading for account closing and collect similar information for the other services on account closing

2.1.2 Steps – Normal Sequence

Describe the normal sequence of events, focusing on steps that identify new types of information or new information exchanges or new interface issues to address. Should the sequence require detailed steps that are also used by other functions, consider creating a new “sub” function, then referring to that “subroutine” in this function. Remember that the focus should be less on the algorithms of the applications and more on the interactions and information flows between “entities”, e.g. people, systems, applications, data bases, etc. There should be a direct link between the narrative and these steps.

The numbering of the sequence steps conveys the order and concurrency and iteration of the steps occur. Using a Dewey Decimal scheme, each level of nested procedure call is separated by a dot ‘.’. Within a level, the sequence number comprises an optional letter and an integer number. The letter specifies a concurrent sequence within the next higher level; all letter sequences are concurrent with other letter sequences. The number specifies the sequencing of messages in a given letter sequence. The absence of a letter is treated as a default ‘main sequence’ in parallel with the lettered sequences.

Sequence 1:

*1.1 - Do step 1
1.2A.1 - In parallel to activity 2 B do step 1
1.2A.2 - In parallel to activity 2 B do step 2
1.2B.1 - In parallel to activity 2 A do step 1
1.2B.2 - In parallel to activity 2 A do step 2
1.3 - Do step 3
1.3.1 - nested step 3.1
1.3.2 - nested step 3.2*

Sequence 2:

*2.1 - Do step 1
2.2 - Do step 2*

#	Event	Primary Actor	Name of Process/Activity	Description of Process/Activity	Information Producer	Information Receiver	Name of Info Exchanged	Additional Notes	IECSA Environments
#	<i>Triggering event? Identify the name of the event.¹</i>	<i>What other actors are primarily responsible for the Process/Activity? Actors are defined in section1.5.</i>	<i>Label that would appear in a process diagram. Use action verbs when naming activity.</i>	<i>Describe the actions that take place in active and present tense. The step should be a descriptive noun/verb phrase that portrays an outline summary of the step. "If ...Then...Else" scenarios can be captured as multiple Actions or as separate steps.</i>	<i>What other actors are primarily responsible for Producing the information? Actors are defined in section1.5.</i>	<i>What other actors are primarily responsible for Receiving the information? Actors are defined in section1.5. (Note – May leave blank if same as Primary Actor)</i>	<i>Name of the information object. Information objects are defined in section 1.6</i>	<i>Elaborate architectural issues using attached spreadsheet. Use this column to elaborate details that aren't captured in the spreadsheet.</i>	<i>Reference the applicable IECSA Environment containing this data exchange. Only one environment per step.</i>
1.0	Customer calls utility	Customer	Request account change	Customer calls utility to request account change	Customer	CSR	Customer account information		Customer / ESP
1.1	Customer call received by CSR	CSR	Identifies Customer Account	Customer service representative (CSR) identifies customer account	CustomerInformationDatabase	CSR	Customer account information	?	Customer / ESP
1.2	Customer request account change	Customer	Service Request Type	CSR determine nature of service request [in this case, account change]	Customer	CSR	Service Request Type		Customer / ESP
1.3		CustomerInformationDatabase	Customer account change	Transfer call to Customer Relocation Specialist	CustomerInformationDatabase	CRS	Customer account change		Customer / ESP
2.1	Customer call	Customer	Request	Customer Relocation	Customer	CRS	Account close		Customer /

¹ Note – A triggering event is not necessary if the completion of the prior step – leads to the transition of the following step.

#	Event	Primary Actor	Name of Process/Activity	Description of Process/Activity	Information Producer	Information Receiver	Name of Info Exchanged	Additional Notes	IECSA Environments
	to utility		Close out current location services	Specialist determines when services to current location are to be turned off			date		ESP
2.2.0	Closing service at current Customer location	CustomerInformationDatabase	Initiate Close out current location services	Customer Relocation Specialist initiates action to turn off power to current location on specified date	CustomerInformationDatabase	CustomerCommunicationPortal	Power turn off command to current location		Customer / ESP
2.2.1	Power Turn-Off Request	CustomerInformationDatabase	Transmit final reading	Customer Relocation Specialist instructs CustomerCommunicationPortal to transmit final reading on service turn off	CustomerInformationDatabase, CustomerCommunicationPortal	Customer billing system	Final reading at current location		Customer / ESP
2.3	Request for Final Billing	Customer billing system	Identify current service provider	CRS accesses regional database to identify services provided to customer at current location using the common customer id	CustomerInformationDatabase, Regional CustomerInformationDatabase	CRS	List of services and service providers to the customer at the current location		Customer / ESP
2.3.1	Customer moving out, Identified current service provider	CRS	Close out current location services	CRS instructs each of the service provider to turn service off to location on specified date	CustomerInformationDatabase, Regional CustomerInformationDatabase, CRS	Customer billing system, Regional CustomerInformationDatabase, CustomerCommunication	Service turn off command to current location		Customer / ESP

#	Event	Primary Actor	Name of Process/Activity	Description of Process/Activity	Information Producer	Information Receiver	Name of Info Exchanged	Additional Notes	IECSA Environments
						Portal, ServiceProviderEnergyServiceProvider			
2.3.2	Customer moving out, request for final billing	Customer billing system, CRS, CustomerCommunication Portal	Transmit final billing information	RS requests each service provider to transmit final billing information on current account	CRS, Regional CustomerInformationDatabase, ServiceProviderEnergyServiceProvider	CustomerInformationDatabase, Customer billing system, Regional CustomerInformationDatabase	Final reading		Customer / ESP
2.4	Customer moving out of the current location, close services	CRS	Close out current location services	CRS instructs the billing system to close current location account	CRS	Customer billing system, Regional CustomerInformationDatabase	account information		Customer / ESP
3.1	Customer moving to a new location	Customer	Set up services at the new customer location	Customer provides new location information to RS	Customer, CustomerInformationDatabase	CRS, CustomerInformationDatabase, Customer billing system, Regional CustomerInformationDatabase	New location information		Customer / ESP

#	Event	Primary Actor	Name of Process/Activity	Description of Process/Activity	Information Producer	Information Receiver	Name of Info Exchanged	Additional Notes	IECSA Environments
3.1.1	Customer moving to a new location, service begin date	Customer	Start up date at the new customer location	Customer indicates when power service is to be resumed at new location	Customer	CRS, CustomerInformationDatabase, Customer billing system	Date for turning on power at new customer location		Customer / ESP
3.1.2	Customer requests to initiate new services	Customer	Customer authorizes CRS	Customer authorizes CRS to initiate other services to the new location on the specified date	Customer, CustomerInformationDatabase, Regional CustomerInformationDatabase	CustomerInformationDatabase, Customer billing system, Regional CustomerInformationDatabase, ServiceProviderEnergyServiceProvider	New location account information		Customer / ESP
3.2	Customer authorizes CRS to initiate services	CRS	CRS instructs system to initiate power service	CRS instructs system to initiate power service to new location on the specified date	CRS, CustomerInformationDatabase	CustomerInformationDatabase, Customer billing system, CustomerCommunication Portal	Turn on power to the new location on the specified date		Customer / ESP
3.2.1		CRS	CRS accesses service providers	CRS accesses regional database to transfer new location information to each of the service providers	CRS, CustomerInformationDatabase, Regional CustomerInformationDatabase	Regional CustomerInformationDatabase	New location account information		Customer / ESP

#	Event	Primary Actor	Name of Process/Activity	Description of Process/Activity	Information Producer	Information Receiver	Name of Info Exchanged	Additional Notes	IECSA Environments
					ase				
3.2.2		CRS	Transfer final billing to new account	CRS instructs billing system to transfer final billing read to the new location account	CRS, CustomerInformationDatabase	Customer billing system	Final billing read from the old customer location		Customer / ESP
3.2.3	Customer moving to a new location, need to link billing	CRS	New location to link to customer account	CRS instructs CustomerCommunicationPortal at new location to link to customer account	CRS, CustomerInformationDatabase	CustomerCommunicationPortal	Customer account information		Customer / ESP
3.2.4		CRS	Send out change confirmation to the customer	CRS instructs billing system to send out change confirmation to the customer	CRS, CustomerInformationDatabase, Customer billing system, Regional CustomerInformationDatabase	Customer, CustomerInformationDatabase, Regional CustomerInformationDatabase, ServiceProviderEnergyServiceProvider	New location account confirmation		Customer / ESP

2.1.3 Steps – Alternative / Exception Sequences

Describe any alternative or exception sequences that may be required that deviate from the normal course of activities. Note instructions are found in previous table.

#	Event	Primary Actor	Name of Process/Activity	Description of Process/Activity	Information Producer	Information Receiver	Name of Info Exchanged	Additional Notes	IECSA Environments

2.1.4 Post-conditions and Significant Results

Describe conditions that must exist at the conclusion of the Function. Identify significant items similar to that in the preconditions section.

Describe any significant results from the Function

<i>Actor/Activity</i>	<i>Post-conditions Description and Results</i>
Customer	Account moved to new location
Service delivery	Turned off at current location and turned on at new location
CustomerInformationDatabase	Updated with new location information
Billing system database	Updated with the new location information

2.2 Architectural Issues in Interactions

Elaborate on all architectural issues in each of the steps outlined in each of the sequences above. Reference the Step by number..

2.3 Diagram

For clarification, draw (by hand, by Power Point, by UML diagram) the interactions, identifying the Steps where possible.

3 Auxiliary Issues

3.1 References and contacts

Documents and individuals or organizations used as background to the function described; other functions referenced by this function, or acting as “sub” functions; or other documentation that clarifies the requirements or activities described. All prior work (intellectual property of the company or individual) or proprietary (non-publicly available) work must be so noted.

ID	Title or contact	Reference or contact information
[1]	P. S. Vishwanath	Paragon Consulting Services, 301-323-4088
[2]	Joe Kelly	Paragon Consulting Services, 503-978-8289

3.2 Action Item List

As the function is developed, identify issues that still need clarification, resolution, or other notice taken of them. This can act as an Action Item list.

ID	Description	Status
[1]		
[2]		

3.3 Revision History

For reference and tracking purposes, indicate who worked on describing this function, and what aspect they undertook.

No	Date	Author	Description
0.1	December 8, 2003	P S V	First draft
0.2	December 16, 2003	P S V	Steps section revised to use separate sub-rows for each sub-step as per MB email

Consumer Portal Scenario P5 Customer Sign-up for Demand Reduction Program

1 Descriptions of Function

All prior work (intellectual property of the company or individual) or proprietary (non-publicly available) work should be so noted.

1.1 Function Name

Name of Function: Customer sign-up for Demand Reduction Program

1.2 Function ID

IECSA identification number of the function

C-2.2

1.3 Brief Description

Describe briefly the scope, objectives, and rationale of the Function

A customer wants to sign up for the Demand Reduction Program offered by the utility which would give the utility permission to cycle customer's air conditioning system during peak load periods in return for incentives. The utility representative signs up the customer, handles installation of needed devices and implements the customer's participation in the program. At a later, the customer asks to be transferred to a different load reduction program level and this change is implemented accordingly.

1.4 Narrative

A complete narrative of the Function from a Domain Expert's point of view, describing what occurs when, why, how, and under what conditions. This will be a separate document, but will act as the basis for identifying the Steps in Section 2.

A western utility has a residential customer base of 1 million meters. The meters are installed in single-family detached housing (SFD), single-family attached housing (SFA), apartment buildings and mobile homes. The utility has a high residential turnover rate as customers come to and leave the service area more frequently than typical utilities.

The utility has demand relief requirements and has multiple demand response programs in place. It additionally supports active residential conservation programs as well as residential alternate, renewable and distributed generation.

The results of all of these efforts are reported to the Sate PUC as part of their requirements to receive credit in rate base.

On Monday morning a residential customer of utility X calls Customer Service and requests a “sign up” in the utility’s air-conditioning demand response programs that they read about in the newspaper. The Customer Service representative [CSR] transfers the call along with the customers account information “utility program specialist” while the customer is still on the line. The program specialist [PS] opens up a computer file that delineates the features and requirements for participation in each of the utilities AC demand reduction program (that includes a gateway product, a smart thermostat product, and a simple switching product, all with different incentives). The customer selects a specific program and the specialist asks pertinent questions about the customer’s participation to help reduce problems. The specialist selects a convenient date for installation of equipment and to start the program at the specific residence. Once the program specifics and the customer specifics are entered into the Demand Response database, the installation company is notified of the specific program requested, the installation date, customer information and specific tracking number/ID. The information is automatically downloaded into a PDA designed to accommodate the data.

The installer places the appropriate equipment, in this case a DLC switch, on the customers AC unit, tests the system with a handheld unit, and places all information into the same PDA as used to download the original request. After the installation is completed, the PDA is connected to the installers computer system in the truck and via a web-hosted database all information is uploaded to the utility. The utility software automatically notifies the DemandResponseProgramManager [DRPM], advises billing that the customer will receive a financial incentive, which is listed on their monthly bill during the appropriate summer months and subtracted from the “amount due” line. At the end of the summer program, the billing software automatically reverts to the normal invoice and removes incentives from the bill.

In addition to billing, the program initiation also triggers a summer-months energy consumption-tracking program. The software recalls specific customer usage data for the previous year for the months of June, July, August and September. The database also includes average daily and monthly ambient temperatures, which will be used with customer usage data to ascertain savings and relative demand reduction. The information is inserted into a database that is used by the DemandResponseProgramManager to assess relative load reduction as well as to determine if free-ridership is an issue.

The residential customer participates in the program through July, but after several 110+ degree-days decides that participating in the program at the 100% cycling strategy (complete AC shut down for the designated curtailment period) is too severe and wants to be placed in the 50% cycling program. The request is placed into the system by the utility program specialist and the customer is automatically removed from the 100% strategy, placed on the 50% strategy, billing is notified automatically and the incentive is recalculated. The Program Manager is notified of the change in participation level, the billing is advised to adjust the financial incentive and the tracking database flagged with the information as well.

1.5 Actor (Stakeholder) Roles

Describe all the people (their job), systems, databases, organizations, and devices involved in or affected by the Function (e.g. operators, system administrators, technicians, end users, service personnel, executives, SCADA system, real-time database, RTO, RTU, IED, power system). Typically, these actors are logically grouped by organization or functional boundaries or just for collaboration purpose of this use case. We need to identify these groupings and their relevant roles and understand the constituency. The same actor could play different roles in different Functions, but only one role in one Function. If the same actor (e.g. the same person) does play multiple roles in one Function, list these different actor-roles as separate rows.

<i>Grouping (Community)'</i>		<i>Group Description</i>
<i>Customer Site</i>		<i>Those entities that are located at customer's premises</i>
<i>Actor Name</i>	<i>Actor Type (person, device, system etc.)</i>	<i>Actor Description</i>
Customer	Person	One requesting the sign up for the Demand Reduction Program.
CustomerCommunicationPortal	Power System	Power System handling communications function at customer's premises
DLCSwitchController	Device	Device performing cycling of the air conditioning unit

Replicate this table for each logic group.

<i>Grouping (Community)'</i>		<i>Group Description</i>
<i>Load Serving Entity Customer Service</i>		<i>Those entities that are charged with handling customer service functions for the power company</i>
<i>Actor Name</i>	<i>Actor Type (person, device, system etc.)</i>	<i>Actor Description</i>
Load Serving Entity	Power System	Power company communications system that handles customer call center services
CSR	Person	Customer Service Representative (CSR), Person who interfaces with the customer initially for the power company
Utility Program Specialist	Person	Person who handles load reduction-related services for the customer
CustomerInformationDatabase	Power System	Power System that contains information about customer accounts of the power company

<i>Grouping (Community)'</i>		<i>Group Description</i>
<i>Load Serving Entity Customer Service</i>		<i>Those entities that are charged with handling customer service functions for the power company</i>
<i>Actor Name</i>	<i>Actor Type (person, device, system etc.)</i>	<i>Actor Description</i>
DemandReductionProgramDatabase	Power System	Power System that contains information about all of the Demand Reduction Program [DemandReductionProgramDatabase] Database offered by the utility, participation requirements, equipment details and links to customer billing system for passing incentive information
DemandReductionProgramDatabase Manager	Person	DemandResponseProgramManager
CustomerBillingSystem	Power System	Power System that handles generation of bills for the services provided to the customer
CustomerId	Device	A common customer identification key that is used by service providers authorized by the customer to identify all of their service accounts
InstallationScheduleDatabase	Power System	Power System that handles scheduling installation of equipment at customer premises [in this case, the DLC switch], specifying equipment to be installed, confirmation of completion of installation and links to the billing system using the common customer id

<i>Grouping (Community)'</i>		<i>Group Description</i>
<i>Installer</i>		<i>Those entities that are associated with the installation function</i>
<i>Actor Name</i>	<i>Actor Type (person, device, system etc.)</i>	<i>Actor Description</i>
Installer	Person	Utility person assigned to handle the specified customer site installation task
DLCSwitchController	Device	Power System handling cycling of air conditioning equipment at customer's premises [generally consists of a RF receiver and a switch component to turn the air conditioning compressor on/off]
InstallationSystem	Power System	Power System for managing the installation activities at the customer site – in this case consists of a PDA that contains the installation order information, a test unit to verify proper installation and software to record installation details
Installer Computer	Power System	Power System for accessing utility's installation database, downloading specific order information to the InstallationSystem PDA, communications link to the utility's network to access order data and to upload confirmation data

<i>Grouping (Community)'</i>		<i>Group Description</i>
<i>Others</i>		<i>Those entities that are involved in this activity, but do not fit in any of the Groupings above</i>
<i>Actor Name</i>	<i>Actor Type (person, device, system etc.)</i>	<i>Actor Description</i>
PublicUtilityCommision	Person	The entity that receives results of the utility's demand reduction program.

<i>Grouping (Community)</i>		<i>Group Description</i>
<i>Others</i>		<i>Those entities that are involved in this activity, but do not fit in any of the Groupings above</i>
<i>Actor Name</i>	<i>Actor Type (person, device, system etc.)</i>	<i>Actor Description</i>
DemandResponseProgramManager	Person	Person managing the DemandReductionProgramDatabase at the utility
EnergyServiceProvider		
ServiceProvider		
AirConditioningEquipment		

1.6 Information exchanged

Describe any information exchanged in this template.

<i>Information Object Name</i>	<i>Information Object Description</i>
Customer Demand Reduction Program Signup Request	Information from the customer call for signing up to participate in the utility's Demand Reduction Program
Customer Power System Installation Order	Information on scheduling the installation at customer's site, equipment to be installed, programming information on cycling regime, details to be passed on to the billing program on initiating incentive reward, intimation to DemandResponseProgramManager and triggers to start tracking energy usage for program performance verification
Program Change Request	Information from the customer call on the changes to be made to the customer's participation level in

<i>Information Object Name</i>	<i>Information Object Description</i>
	the utility's Demand Reduction Program
Program Change Confirmation	Information confirming the changes made to the account based on the customer call, with appropriate notification and triggers as per those initiated on program activation

1.7 Activities/Services

Describe or list the activities and services involved in this Function (in the context of this Function). An activity or service can be provided by a computer system, a set of applications, or manual procedures. These activities/services should be described at an appropriate level, with the understanding that sub-activities and services should be described if they are important for operational issues, automation needs, and implementation reasons. Other sub-activities/services could be left for later analysis.

<i>Activity/Service Name</i>	<i>Activities/Services Provided</i>
Signup Customer to Requested Demand Reduction Program	Initiate actions to modify customer's account information to indicate details of participation in the Demand Reduction Program specified by the customer and generate trigger to installation scheduling program
Set Up Customer Power System Installation Order	Initiate actions to schedule installation at customer site, and transmit customer site information, equipment details and scheduling to the installer
Power System Installation	Perform installation at customer site, verify system performance, and upload installation confirmation back to utility
Installation Follow-up	Initiate actions to update load reduction system to send out appropriate control signals to customer unit, update customer billing information with applicable incentives, alert the applicable DemandResponseProgramManager about installation, initiate energy usage tracking, and set up flags in the billing database to revert to regular billing at the end of incentive period
Customer Request to Change Program Participation	Initiate actions to modify customer account information with the change to the program participation, transmit revised incentive information to billing system, and alert the applicable DemandResponseProgramManager about change in participation level

<i>Activity/Service Name</i>	<i>Activities/Services Provided</i>
Program Change Conformation	Initiate actions to generate a confirmation message to the customer with details of the change made in program participation level and the applicable incentive rewards at the new level

1.8 Contracts/Regulations

Identify any overall (human-initiated) contracts, regulations, policies, financial considerations, engineering constraints, pollution constraints, and other environmental quality issues that affect the design and requirements of the Function.

<i>Contract/Regulation</i>	<i>Impact of Contract/Regulation on Function</i>
Demand Reduction Program Tariffs	Equipment installed at customer site, cycling regime implemented and incentive rewards applied to customer bill

<i>Policy</i>	<i>From Actor</i>	<i>May</i>	<i>Shall Not</i>	<i>Shall</i>	<i>Description (verb)</i>	<i>To Actor</i>
Cycle Energy to Equipment	EnergyServiceProvider	X			Cycle power to air conditioning unit on utility trigger	AirConditioningEquipment
Provide Load Control Equipment	ServiceProvider			X	Install specified equipment at customer site	Customer
Provide Incentive Rewards	EnergyServiceProvider			X	Provide incentive reward on customer energy bill	Customer
Modify Incentive Rewards	EnergyServiceProvider			X	Modify incentive reward on customer energy bill	Customer

<i>Constraint</i>	<i>Type</i>	<i>Description</i>	<i>Applies to</i>
<i>Program Participation</i>	<i>Level of Participation</i>	<i>The level of Demand Reduction Program participation chosen by the customer</i>	<i>Power cycling regime implemented and amount of incentive reward provided</i>
<i>Reward Period</i>	<i>Inactive</i>	<i>Months of the year when the program is not active [i.e., non-summer months for this program]</i>	<i>No incentive reward provided</i>
<i>Energy Usage</i>	<i>Minimum Threshold</i>	<i>Tracked energy usage to meet or exceed program requirements to qualify to participate in the program and receive incentive reward on bill</i>	<i>Eligibility to continue participation in the program</i>

2 Step by Step Analysis of Function

Describe steps that implement the function. If there is more than one set of steps that are relevant, make a copy of the following section grouping (Preconditions and Assumptions, Steps normal sequence, and Steps alternate or exceptional sequence, Post conditions)

2.1 Steps to implement function

Name of this sequence.

2.1.1 Preconditions and Assumptions

Describe conditions that must exist prior to the initiation of the Function, such as prior state of the actors and activities

Identify any assumptions, such as what systems already exist, what contractual relations exist, and what configurations of systems are probably in place

Identify any initial states of information exchanged in the steps in the next section. For example, if a purchase order is exchanged in an activity, its precondition to the activity might be 'filled in but unapproved'.

<i>Actor/System/Information/Contract</i>	<i>Preconditions or Assumptions</i>
CustomerId	Assumes that a common customer id is used by the customer service, Demand Reduction Program, installation and billing departments
Demand Reduction Program tariff	Assumes that a tariff exists with details of program requirements and incentive rewards that the customer can sign up
CustomerCommunicationPortal	Assumes that the CustomerCommunicationPortal is installed in the customer location that will permit usage monitoring at specific times to verify program effectiveness

2.1.2 Steps – Normal Sequence

Describe the normal sequence of events, focusing on steps that identify new types of information or new information exchanges or new interface issues to address. Should the sequence require detailed steps that are also used by other functions, consider creating a new “sub” function, then referring to that “subroutine” in this function. Remember that the focus should be less on the algorithms of the applications and more on the interactions and information flows between “entities”, e.g. people, systems, applications, data bases, etc. There should be a direct link between the narrative and these steps.

The numbering of the sequence steps conveys the order and concurrency and iteration of the steps occur. Using a Dewey Decimal scheme, each level of nested procedure call is separated by a dot ‘.’. Within a level, the sequence number comprises an optional letter and an integer number. The letter specifies a concurrent sequence within the next higher level; all letter sequences are concurrent with other letter sequences. The number specifies the sequencing of messages in a given letter sequence. The absence of a letter is treated as a default ‘main sequence’ in parallel with the lettered sequences.

Sequence 1:

*1.1 - Do step 1
1.2A.1 - In parallel to activity 2 B do step 1
1.2A.2 - In parallel to activity 2 B do step 2
1.2B.1 - In parallel to activity 2 A do step 1
1.2B.2 - In parallel to activity 2 A do step 2
1.3 - Do step 3
1.3.1 - nested step 3.1
1.3.2 - nested step 3.2*

Sequence 2:

*2.1 - Do step 1
2.2 - Do step 2*

#	Event	Primary Actor	Name of Process/Activity	Description of Process/Activity	Information Producer	Information Receiver	Name of Info Exchanged	Additional Notes	IECSA Environments
#	<i>Triggering event? Identify the name of the event.¹</i>	<i>What other actors are primarily responsible for the Process/Activity? Actors are defined in section 1.5.</i>	<i>Label that would appear in a process diagram. Use action verbs when naming activity.</i>	<i>Describe the actions that take place in active and present tense. The step should be a descriptive noun/verb phrase that portrays an outline summary of the step. "If ...Then...Else" scenarios can be captured as multiple Actions or as separate steps.</i>	<i>What other actors are primarily responsible for Producing the information? Actors are defined in section 1.5.</i>	<i>What other actors are primarily responsible for Receiving the information? Actors are defined in section 1.5. (Note – May leave blank if same as Primary Actor)</i>	<i>Name of the information object. Information objects are defined in section 1.6</i>	<i>Elaborate architectural issues using attached spreadsheet. Use this column to elaborate details that aren't captured in the spreadsheet.</i>	<i>Reference the applicable IECSA Environment containing this data exchange. Only one environment per step.</i>
1.1	Customer call to utility	Customer, CSR	Request program signup	Customer service representative identifies customer account	CustomerInformationDatabase	CSR	Customer account information	?	Customer / ESP
1.2		CSR	Service Request Type	CSR determines nature of service request [in this case, signup for DemandReductionProgramDatabase]	Customer	CSR	Program signup request		Customer / ESP
1.3		CSR	Transfer call	Transfers call to utility's Program Specialist	CSR	Utility Program Specialist	Customer account information, Program signup request		Customer / ESP
2.1	Customer interest in	Customer, Utility Program	Determine which DLRP is	Utility Program Specialist determines	CustomerInformationDatabase,	Customer	DemandReductionProgramDatabas		Customer / ESP

¹ Note – A triggering event is not necessary if the completion of the prior step – leads to the transition of the following step.

#	Event	Primary Actor	Name of Process/Activity	Description of Process/Activity	Information Producer	Information Receiver	Name of Info Exchanged	Additional Notes	IECSA Environments
	signing up for DLRP	Specialist	appropriate for customer	which level of DLRP is appropriate for this customer	DemandReductionProgramDatabase		e details		
2.1.1		Utility Program Specialist	Signup customer to specific DLRP	Program Specialist signs up customer to the DLC switch program	CustomerInformationDatabase, DemandReductionProgramDatabase	Customer, CustomerBillingSystem	Specific program requirements and reward incentives		Customer / ESP
2.1.2	Determines specific DLRP	Utility Program Specialist	Schedules installation	Program Specialist schedules installation	CustomerInformationDatabase	Customer site installation database	Installation details		Customer / ESP
2.2	Request to install specific DLRP	Installer	Installation by service provider	Specified equipment is installed and tested by installation service providers	Installer	CustomerInformationDatabase, DemandReductionProgramDatabase Manager, CustomerBillingSystem	Installation confirmation		Customer / ESP
2.3	Installed new customer site installation	CustomerCommunicationPortal	CustomerCommunicationPortal to monitor energy usage	CustomerCommunicationPortal is alerted to monitor energy usage and ambient temperatures	CustomerCommunicationPortal, CustomerInformationDatabase	DemandReductionProgramDatabase	Average and peak temperatures, customer's historical energy usage and current energy usage		Customer / ESP
2.4		CustomerBillingSystem	Billing system generates billing	Billing system generates summer billing with applicable reward incentives	CustomerBillingSystem	Customer	Monthly billing with deductions for applicable incentives		Customer / ESP

#	Event	Primary Actor	Name of Process/Activity	Description of Process/Activity	Information Producer	Information Receiver	Name of Info Exchanged	Additional Notes	IECSA Environments
3.1	Customer request to change participation level	Customer	Change DemandReductionProgramDatabase participation level	Customer requests change from 100% to 50% cycling program level	Customer, CustomerInformationDatabase	Utility Program Specialist	Changes in program participation level		Customer / ESP
3.2	Utility Program Specialist receives change of participation request	Utility Program Specialist	Program Specialist confirms change	Program Specialist confirms change in cycling rate and corresponding reward incentives	Utility Program Specialist	Customer, CustomerInformationDatabase, DemandReductionProgramDatabase	Program participation change		Customer / ESP
3.3	Customers participation level is changed	CustomerInformationDatabase	Affected parties are informed	Applicable affected parties are informed of the change	CustomerInformationDatabase	CustomerBillingSystem, DemandReductionProgramDatabase Manager	Change in participation level and reward incentive change		Customer / ESP
3.4		DemandReductionProgramDatabase	CustomerCommunicationPortal and DLC system notified	CustomerCommunicationPortal and DLC system notified of cycling rate change	DemandReductionProgramDatabase	CustomerCommunicationPortal, DLCSwitchController	Programming change to DLC for new cycling rate and revised monitoring instructions to CustomerCommunicationPortal		Customer / ESP

2.1.3 Steps – Alternative / Exception Sequences

Describe any alternative or exception sequences that may be required that deviate from the normal course of activities. Note instructions are found in previous table.

#	Event	Primary Actor	Name of Process/Activity	Description of Process/Activity	Information Producer	Information Receiver	Name of Info Exchanged	Additional Notes	IECSA Environments

2.1.4 Post-conditions and Significant Results

Describe conditions that must exist at the conclusion of the Function. Identify significant items similar to that in the preconditions section.

Describe any significant results from the Function

<i>Actor/Activity</i>	<i>Post-conditions Description and Results</i>
Consumer	50% cycling rate on air conditioning equipment and revised reward incentives on monthly bills
DLC switch system	Implement 50% cycling instructions at customer site
CustomerInformationDatabase	Updated with revised program participation level information
Billing system database	Updated with revised reward incentive information
DemandReductionProgramDatabase database	Updated with change to the program participation level
DemandReductionProgramDatabase Manager	Updated with change in program participation level

2.2 Architectural Issues in Interactions

Elaborate on all architectural issues in each of the steps outlined in each of the sequences above. Reference the Step by number..

2.3 Diagram

For clarification, draw (by hand, by Power Point, by UML diagram) the interactions, identifying the Steps where possible.

3 Auxiliary Issues

3.1 References and contacts

Documents and individuals or organizations used as background to the function described; other functions referenced by this function, or acting as “sub” functions; or other documentation that clarifies the requirements or activities described. All prior work (intellectual property of the company or individual) or proprietary (non-publicly available) work must be so noted.

ID	Title or contact	Reference or contact information
[1]	P. S. Vishwanath	Paragon Consulting Services, 301-323-4088
[2]	Joe Kelly	Paragon Consulting Services, 503-978-8289

3.2 Action Item List

As the function is developed, identify issues that still need clarification, resolution, or other notice taken of them. This can act as an Action Item list.

ID	Description	Status
[1]		
[2]		

3.3 Revision History

For reference and tracking purposes, indicate who worked on describing this function, and what aspect they undertook.

No	Date	Author	Description
0.1	December 15, 2003	P S V	Initial draft
0.2	December 30, 2003	P S V	Edits and corrections

Consumer Portal P6 Customer Needs Meter Device

1 Descriptions of Function

All prior work (intellectual property of the company or individual) or proprietary (non-publicly available) work should be so noted.

1.1 Function Name

Name of Function: Customer sign-up for Demand Reduction Program needing the installation of a new interval meter

1.2 Function ID

IECSA identification number of the function

C-2.2

1.3 Brief Description

Describe briefly the scope, objectives, and rationale of the Function

A customer wants to sign up for the Demand Reduction Program offered by the utility which would give the utility permission to cycle customer's air conditioning system during peak load periods in return for incentives. The utility representative signs up the customer, handles installation of needed devices along with a new interval meter for gathering Measurement and Verification data and implements the customer's participation in the program. The data collected by the interval meter is used in report to the PublicUtilityCommision as well as to provide Power Purchases department at the utility with a tool for economic dispatch, and to the Transmission and Distribution (Transmission Service Provider) department at the utility for load reduction dispatch by Transmission Service Provider circuit.

1.4 Narrative

A complete narrative of the Function from a Domain Expert's point of view, describing what occurs when, why, how, and under what conditions. This will be a separate document, but will act as the basis for identifying the Steps in Section 2.

A western utility has a residential customer base of 1 million meters. The meters are installed in single-family detached housing (SFD), single-family attached housing (SFA), apartment buildings and mobile homes. The utility has a high residential turnover rate as customers come to and leave the service area more frequently than typical utilities.

The utility has demand relief requirements and has multiple demand response programs in place. It additionally supports active residential conservation programs as well as residential alternate, renewable and distributed generation.

The results of all of these efforts are reported to the State PUC as part of their requirements to receive credit in rate base.

On Monday morning a residential customer of utility X calls Customer Service and requests a “sign up” in the utility’s air-conditioning demand response programs that they read about in the newspaper. The Customer Service (CSR) representative transfers the call along with the customer’s account information “utility program specialist” while the customer is still on the line. The program specialist (PS) opens up a computer file that delineates the features and requirements for participation in each of the utility’s AC demand reduction program (that includes a gateway product, a smart thermostat product, and a simple switching product, all with different incentives). The customer selects a specific program and the specialist asks pertinent questions about the customer’s participation to help reduce problems.

The specialist sees a “flag” that shows that the customer is in a new subdivision and that the utility needs additional Measurement & Verification (M & V) data in that area. The specialist selects a convenient date for installation of equipment, including a new interval meter, and to start the program at the specific residence. Once the program specifics and the customer specifics are entered into the Demand Response database, the installation company is notified of the specific program requested, the installation date, customer information and specific tracking number/ID. The information is automatically downloaded into a PDA designed to accommodate the data. The meter shop is also notified and prepares a meter installation at the same time as the curtailment equipment. The meter number and associated information is loaded into the PDA for processing along with the other data.

The installer places the appropriate equipment, in this case a DLC switch, on the customer’s AC unit, tests the system with a handheld unit, and places all information (including the meter ID) into the same PDA as used to download the original request. At the end of the day, the PDA is connected to the installer’s computer system and via a web-hosted database all information is uploaded to the utility. The utility software automatically notifies the DemandResponseProgramManager (DRPM), advises billing that the customer will receive a financial incentive, which is listed on their monthly bill during the appropriate summer months and subtracted from the “amount due” line. At the end of the summer program, the billing software automatically reverts to the normal invoice and removes incentives from the bill.

In addition to billing, the program initiation also triggers a summer-months energy consumption-tracking program. The software recalls specific customer usage data for the previous year for the months of June, July, August and September. The database also includes average daily and monthly ambient temperatures, which will be used with customer usage data to ascertain savings and relative demand reduction. The information is inserted into a database that is used by the DemandResponseProgramManager to assess relative load reduction as well as to determine if free-

ridership is an issue. In this case the meter data is also collected remotely by a contracted M & V firm via satellite. The data is logged in and specific software calculates actual demand reduction during the summer curtailment periods. The data is used to advise the PUC of program results as well as to provide Power Purchases department at the utility with a tool for economic dispatch, and to the Transmission and Distribution (Transmission Service Provider) department at the utility for load reduction dispatch by Transmission Service Provider circuit.

1.5 Actor (Stakeholder) Roles

Describe all the people (their job), systems, databases, organizations, and devices involved in or affected by the Function (e.g. operators, system administrators, technicians, end users, service personnel, executives, SCADA system, real-time database, RTO, RTU, IED, power system). Typically, these actors are logically grouped by organization or functional boundaries or just for collaboration purpose of this use case. We need to identify these groupings and their relevant roles and understand the constituency. The same actor could play different roles in different Functions, but only one role in one Function. If the same actor (e.g. the same person) does play multiple roles in one Function, list these different actor-roles as separate rows.

<i>Grouping (Community)</i>		<i>Group Description</i>
<i>Customer Site</i>		<i>Those entities that are located at customer’s premises</i>
<i>Actor Name</i>	<i>Actor Type (person, device, system etc.)</i>	<i>Actor Description</i>
Customer	Person	One requesting the sign up for the Demand Reduction Program.
CustomerCommunicationPortal	System	System handling communications function at customer’s premises
DLCSwitchController	Device	Device performing cycling of the air conditioning unit
Meter Device	Device	Device capturing energy usage data for use in Measurement & Verification purposes.
RemoteMeterDevice	System	System for transmitting interval meter data on demand to the utility [in this case, using a satellite communications link provided by a third party contracted by the

<i>Grouping (Community)'</i>		<i>Group Description</i>
<i>Customer Site</i>		<i>Those entities that are located at customer's premises</i>
<i>Actor Name</i>	<i>Actor Type (person, device, system etc.)</i>	<i>Actor Description</i>
		utility].

Replicate this table for each logic group.

<i>Grouping (Community)'</i>		<i>Group Description</i>
<i>Load Serving Entity Customer Service</i>		<i>Those entities that are charged with handling customer service functions for the power company</i>
<i>Actor Name</i>	<i>Actor Type (person, device, system etc.)</i>	<i>Actor Description</i>
Load Serving Entity	System	Power company communications system that handles customer call center services
CSR	Person	Customer Service Representative (CSR), Person who interfaces with the customer initially for the power company
Utility Program Specialist	Person	Person who handles load reduction-related services for the customer
CustomerInformationDatabase	System	System that contains information about customer accounts of the power company
DemandReductionProgramDatabase	System	System that contains information about all of the Demand Reduction Program [DemandReductionProgramDatabase] Database offered by the utility, participation requirements, equipment details and links to customer billing system

<i>Grouping (Community)</i>		<i>Group Description</i>
<i>Load Serving Entity Customer Service</i>		<i>Those entities that are charged with handling customer service functions for the power company</i>
<i>Actor Name</i>	<i>Actor Type (person, device, system etc.)</i>	<i>Actor Description</i>
		for passing incentive information
CustomerBillingSystem	System	System that handles generation of bills for the services provided to the customer
Customer ID Creation	Device	A common customer identification key that is used by service providers authorized by the customer to identify all of their service accounts
CustomerSiteInstallationDatabase	System	System that handles scheduling installation of equipment at customer premises [in this case, the DLC switch], specifying equipment to be installed, confirmation of completion of installation and links to the billing system using the common customer id
M & V Information Database	System	System that contains M & V information broken down by utility service area segments [such as residential subdivisions] that can be used by various utility departments, such as Power Purchase, Transmission Service Provider, etc

<i>Grouping (Community)</i>		<i>Group Description</i>
<i>Installer</i>		<i>Those entities that are associated with the installation function</i>
<i>Actor Name</i>	<i>Actor Type (person, device, system etc.)</i>	<i>Actor Description</i>
Installer	Person	Utility person assigned to handle the specified customer site installation task

<i>Grouping (Community)</i>		<i>Group Description</i>
<i>Installer</i>		<i>Those entities that are associated with the installation function</i>
<i>Actor Name</i>	<i>Actor Type (person, device, system etc.)</i>	<i>Actor Description</i>
DLCSwitchController	System	System handling cycling of air conditioning equipment at customer's premises [generally consists of a RF receiver and a switch component to turn the air conditioning compressor on/off].
Meter Device	Device	Device for capturing energy usage information along with time periods during the day when the energy was consumed.
MeterID Provider	Device	Unique identifier that can be used by the utility to track specific meter installed at customer site, in this case the new interval meter
RemoteMeter Device	System	System for transmitting interval meter data on demand to the utility [in this case, using a satellite communications link provided by a third party contracted by the utility].
InstallationSystem	System	System for managing the installation activities at the customer site – in this case consists of a PDA that contains the installation order information, a test unit to verify proper installation and software to record installation details.
Installer Computer	System	System for accessing utility's installation database, downloading specific order information to the InstallationSystem PDA, communications link to the utility's network to access order data and to upload confirmation data.
CustomerSiteInstallationDatabase	System	System that handles scheduling installation of equipment at customer premises [in this case, the DLC switch], specifying equipment to be installed, confirmation of completion of installation and links to the billing system using the common customer id

<i>Grouping (Community)</i>		<i>Group Description</i>
<i>Others</i>		<i>Those entities that are involved in this activity, but do not fit in any of the Groupings above</i>
<i>Actor Name</i>	<i>Actor Type (person, device, system etc.)</i>	<i>Actor Description</i>
Metering	Person	Department at the utility that manages meters and their installation at the customer site
Power Purchase	Person	Department at the utility company that handles procurement of power resources for the utility company.
Transmission Service Provider	Person	Department at the utility company that handles the Transmission and Distribution (T&D) functions for the utility company.
Satellite Communications Network	System	System responsible for remote meter reading and transmitting the data to the utility company.
PublicUtilityCommission	Person	State Public Utility Commission {PUC}: The entity that receives results of the utility's demand reduction program.
DemandResponseProgramManager	Person	Person managing the DemandReductionProgramDatabase at the utility
EnergyServiceProvider		
ServiceProvider		
AirConditioningEquipment		

1.6 Information exchanged

Describe any information exchanged in this template.

<i>Information Object Name</i>	<i>Information Object Description</i>
Customer Demand Reduction Program Signup Request	Information from the customer call for signing up to participate in the utility's Demand Reduction Program
Customer System Installation Order	Information on scheduling the installation at customer's site, equipment to be installed [interval meter, remote meter reading module and DLC], programming information on cycling regime, details to be passed on to the billing program on initiating incentive reward, intimation to DemandResponseProgramManager and triggers to start tracking energy usage for program performance verification, and interval data for utility's M & V functions
M & V Information Request	Information trigger generated by the utility's customer information database to initiate recording of interval energy usage data
M & V Information Delivery	Delivery of M & V information collected from customer's site to utility's Power Purchase and Transmission Service Provider departments and to the PublicUtilityCommision for program results verification

1.7 Activities/Services

Describe or list the activities and services involved in this Function (in the context of this Function). An activity or service can be provided by a computer system, a set of applications, or manual procedures. These activities/services should be described at an appropriate level, with the understanding that sub-activities and services should be described if they are important for operational issues, automation needs, and implementation reasons. Other sub-activities/services could be left for later analysis.

<i>Activity/Service Name</i>	<i>Activities/Services Provided</i>
Signup Customer to Requested Demand Reduction Program	Initiate actions to modify customer's account information to indicate details of participation in the Demand Reduction Program specified by the customer, generate trigger to installation scheduling program, and generate trigger to the Metering Department to install a new interval meter for M & V

<i>Activity/Service Name</i>	<i>Activities/Services Provided</i>
	functionality
Set Up Customer System Installation Order	Initiate actions to schedule installation at customer site, and transmit customer site information, equipment details and scheduling to the installer
System Installation	Perform installation of specified load control system at customer site, verify system performance, and upload installation confirmation back to utility; perform installation of interval meter with remote meter reading module, verify operation and notify utility of interval meter installation
Installation Follow-up	Initiate actions to update load reduction system to send out appropriate control signals to customer unit, update customer billing information with applicable incentives, alert the applicable DemandResponseProgramManager about installation, initiate energy usage tracking, initiate obtaining interval data and set up flags in the billing database to revert to regular billing at the end of incentive period
M & V Information Delivery	Initiate actions to transmit interval energy usage data to utility's Power Purchase and Transmission Service Provider departments, and transmit results of the DemandReductionProgramDatabase to the PublicUtilityCommision

1.8 Contracts/Regulations

Identify any overall (human-initiated) contracts, regulations, policies, financial considerations, engineering constraints, pollution constraints, and other environmental quality issues that affect the design and requirements of the Function.

<i>Contract/Regulation</i>	<i>Impact of Contract/Regulation on Function</i>
Demand Reduction Program Tariffs	Equipment installed at customer site, cycling regime implemented and incentive rewards applied to customer bill

<i>Policy</i>	<i>From Actor</i>	<i>May</i>	<i>Shall Not</i>	<i>Shall</i>	<i>Description (verb)</i>	<i>To Actor</i>
Cycle Energy to Equipment	EnergyServiceProvider	X			Cycle power to air conditioning unit on utility trigger	AirConditioningEquipment
Provide Load Control Equipment	ServiceProvider			X	Install specified equipment at customer site	Customer
Provide Incentive Rewards	EnergyServiceProvider			X	Provide incentive reward on customer energy bill	Customer
Modify Incentive Rewards	EnergyServiceProvider			X	Modify incentive reward on customer energy bill	Customer
Install Meter Device	EnergyServiceProvider			X	Install new interval meter at customer site with remote meter reading capability	EnergyServiceProvider

<i>Constraint</i>	<i>Type</i>	<i>Description</i>	<i>Applies to</i>
<i>Program Participation</i>	<i>Level of Participation</i>	<i>The level of Demand Reduction Program participation chosen by the customer</i>	<i>Power cycling regime implemented and amount of incentive reward provided</i>
<i>Reward Period</i>	<i>Inactive</i>	<i>Months of the year when the program is not active [i.e., non-summer months for this program]</i>	<i>No incentive reward provided</i>
<i>Energy Usage</i>	<i>Minimum Threshold</i>	<i>Tracked energy usage to meet or exceed program requirements to qualify to participate in the program and receive incentive reward on bill</i>	<i>Eligibility to continue participation in the program</i>

2 Step by Step Analysis of Function

Describe steps that implement the function. If there is more than one set of steps that are relevant, make a copy of the following section grouping (Preconditions and Assumptions, Steps normal sequence, and Steps alternate or exceptional sequence, Post conditions)

2.1 Steps to implement function

Name of this sequence.

2.1.1 Preconditions and Assumptions

Describe conditions that must exist prior to the initiation of the Function, such as prior state of the actors and activities

Identify any assumptions, such as what systems already exist, what contractual relations exist, and what configurations of systems are probably in place

Identify any initial states of information exchanged in the steps in the next section. For example, if a purchase order is exchanged in an activity, its precondition to the activity might be 'filled in but unapproved'.

<i>Actor/System/Information/Contract</i>	<i>Preconditions or Assumptions</i>
Customer ID Creation	Assumes that a common customer id is used by the customer service, Demand Reduction Program, installation and billing departments
Demand Reduction Program tariff	Assumes that a tariff exists with details of program requirements and incentive rewards that the customer can sign up
CustomerCommunicationPortal	Assumes that the CustomerCommunicationPortal is installed in the customer location that will permit usage monitoring at specific times to verify program effectiveness
Meter Device	Based on the availability of meter with remote meter reading module and satellite-based communications network

<i>Actor/System/Information/Contract</i>	<i>Preconditions or Assumptions</i>
MeterID Provider	Assumes that a unique meter id is assigned to customer's meter and is used for the interval energy usage information tracking

2.1.2 Steps – Normal Sequence

Describe the normal sequence of events, focusing on steps that identify new types of information or new information exchanges or new interface issues to address. Should the sequence require detailed steps that are also used by other functions, consider creating a new “sub” function, then referring to that “subroutine” in this function. Remember that the focus should be less on the algorithms of the applications and more on the interactions and information flows between “entities”, e.g. people, systems, applications, data bases, etc. There should be a direct link between the narrative and these steps.

The numbering of the sequence steps conveys the order and concurrency and iteration of the steps occur. Using a Dewey Decimal scheme, each level of nested procedure call is separated by a dot ‘.’. Within a level, the sequence number comprises an optional letter and an integer number. The letter specifies a concurrent sequence within the next higher level; all letter sequences are concurrent with other letter sequences. The number specifies the sequencing of messages in a given letter sequence. The absence of a letter is treated as a default ‘main sequence’ in parallel with the lettered sequences.

Sequence 1:

*1.1 - Do step 1
1.2A.1 - In parallel to activity 2 B do step 1
1.2A.2 - In parallel to activity 2 B do step 2
1.2B.1 - In parallel to activity 2 A do step 1
1.2B.2 - In parallel to activity 2 A do step 2
1.3 - Do step 3
1.3.1 - nested step 3.1
1.3.2 - nested step 3.2*

Sequence 2:

*2.1 - Do step 1
2.2 - Do step 2*

#	Event	Primary Actor	Name of Process/Activity	Description of Process/Activity	Information Producer	Information Receiver	Name of Info Exchanged	Additional Notes	IECSA Environments
#	<i>Triggering event? Identify the name of the event.¹</i>	<i>What other actors are primarily responsible for the Process/Activity? Actors are defined in section 1.5.</i>	<i>Label that would appear in a process diagram. Use action verbs when naming activity.</i>	<i>Describe the actions that take place in active and present tense. The step should be a descriptive noun/verb phrase that portrays an outline summary of the step. "If ...Then...Else" scenarios can be captured as multiple Actions or as separate steps.</i>	<i>What other actors are primarily responsible for Producing the information? Actors are defined in section 1.5.</i>	<i>What other actors are primarily responsible for Receiving the information? Actors are defined in section 1.5. (Note – May leave blank if same as Primary Actor)</i>	<i>Name of the information object. Information objects are defined in section 1.6</i>	<i>Elaborate architectural issues using attached spreadsheet. Use this column to elaborate details that aren't captured in the spreadsheet.</i>	<i>Reference the applicable IECSA Environment containing this data exchange. Only one environment per step.</i>
1.1	Customer call to utility	Customer	Request program signup	Customer service representative identifies customer account	CustomerInformationDatabase	CSR	Customer account information	?	Customer / ESP
1.2		CSR	CSR determines nature of service request	CSR determines nature of service request [in this case, signup for DemandReductionProgramDatabase]	Customer	CSR	Program signup request		Customer / ESP
1.3		CSR	Transfers call to Program Specialist	Transfers call to utility's Program Specialist	CSR	Utility Program Specialist	Customer account information, Program signup request		Customer / ESP
2.1	Customer interest in signing up for DLRP	Utility Program Specialist	Determines specific DLRP	Utility Program Specialist determines which level of DLRP is appropriate for this customer	CustomerInformationDatabase, DemandReductionProgramDatabase	Customer	DLRP details		Customer / ESP

¹ Note – A triggering event is not necessary if the completion of the prior step – leads to the transition of the following step.

#	Event	Primary Actor	Name of Process/Activity	Description of Process/Activity	Information Producer	Information Receiver	Name of Info Exchanged	Additional Notes	IECSA Environments
2.1.1		Utility Program Specialist	Signup customer to specific DLRP	Program Specialist signs up customer to the DLC switch program	CustomerInformationDatabase, DemandReductionProgram Database	Customer, CustomerBillingSystem	Specific program requirements and reward incentives		Customer / ESP
2.1.2		Utility Program Specialist	Schedules installation	Program Specialist schedules installation	CustomerInformationDatabase	CustomerSite InstallationDatabase, Installer	Installation details		Customer / ESP
2.2	Request to install equipment for customer by Utility Program Specialist	Installer	Equipment is installed	Specified equipment is installed and tested by installation service providers	Installer	CustomerSite InstallationDatabase, DemandReductionProgram Database Manager, CustomerBillingSystem	Installation confirmation		Customer / ESP
2.3	New customer installation	CustomerCommunication Portal	Monitor energy usage	CustomerCommunication Portal is alerted to monitor energy usage and ambient temperatures	CustomerCommunication Portal, CustomerInformationDatabase	DemandReductionProgram Database	Average and peak temperatures, customer's historical energy usage and current energy usage		Customer / ESP
2.4		CustomerBillingSystem	Billing system generates	Billing system generates summer billing with applicable reward	CustomerBillingSystem	Customer	Monthly billing with deductions for applicable		Customer / ESP

#	Event	Primary Actor	Name of Process/Activity	Description of Process/Activity	Information Producer	Information Receiver	Name of Info Exchanged	Additional Notes	IECSA Environments
			billing	incentives			incentives		
3.1	Customer interest in signing up for DLRP	Utility Program Specialist	Flag Customer is in a new subdivision	Utility Program Specialist notices “flag” that the customer is in a new subdivision where the utility needs additional M & V data	CustomerInformationDatabase, M & V Information Database	Utility Program Specialist	Flag requesting additional M & V data in customer’s location		Customer / ESP
3.2		Utility Program Specialist	Initiates new interval meter installation request	Utility Program Specialist initiates new interval meter installation request	Utility Program Specialist, CustomerInformationDatabase	Utility Metering Department	Customer information and interval meter details		Customer / ESP
3.2.1	Initiates new interval meter installation request	Utility Metering Department	Metering delegates task to installation service provider (installer)	Metering delivers meter with its assigned meter id to the installation service provider	Utility Metering Department	CustomerSiteInstallationDatabase, Installer	New interval meter, its id details, RemoteMeterDevice and associated installation information		Customer / ESP
3.2.2	New meter installation request	Installer	Installs meter at customer site	Installation service provider uploads confirmation after the meter is installed in service at the customer site	Installer, Installer Computer	CustomerInformationDatabase, CustomerSiteInstallationDatabase, Utility Metering Department, Satellite	Notification of the active interval meter and its id details		Customer / ESP

#	Event	Primary Actor	Name of Process/Activity	Description of Process/Activity	Information Producer	Information Receiver	Name of Info Exchanged	Additional Notes	IECSA Environments
						Communications Network			
3.3		Meter Device, RemoteMeter Device, Satellite Communications Network	Collect M & V data	Initiate collection of M & V data from customer site	Meter Device, RemoteMeter Device, Satellite Communications Network	CustomerInformationDatabase, DemandReductionProgram Database, DemandReductionProgram Database Manager, M & V Information Database, Power Purchase, Transmission Service Provider, PublicUtility Commision	Actual demand reduction during the summer curtailment periods		Customer / ESP

2.1.3 Steps – Alternative / Exception Sequences

Describe any alternative or exception sequences that may be required that deviate from the normal course of activities. Note instructions are found in previous table.

#	Event	Primary Actor	Name of Process/Activity	Description of Process/Activity	Information Producer	Information Receiver	Name of Info Exchanged	Additional Notes	IECSA Environments

2.1.4 Post-conditions and Significant Results

Describe conditions that must exist at the conclusion of the Function. Identify significant items similar to that in the preconditions section.

Describe any significant results from the Function

<i>Actor/Activity</i>	<i>Post-conditions Description and Results</i>
Consumer	Program cycling rate on air conditioning equipment and corresponding reward incentives on monthly bills; interval meter installed on site
DLC switch system	Implement program cycling instructions at customer site
CustomerInformationDatabase	Updated with requested program participation level information
Billing system database	Updated with applicable reward incentive information
DLRP database	Updated with assigned program participation level
DemandReductionProgramDatabase Manager	Updated with program participation level
M & V information database	Updated with actual energy usage information at customer site
Power Purchase	Tool to plan economic power dispatch

<i>Actor/Activity</i>	<i>Post-conditions Description and Results</i>
Transmission Service Provider	Tool for load reduction dispatch by Transmission Service Provider circuit
PublicUtilityCommision	Verification information of DLRP performance results

2.2 Architectural Issues in Interactions

Elaborate on all architectural issues in each of the steps outlined in each of the sequences above. Reference the Step by number..

2.3 Diagram

For clarification, draw (by hand, by Power Point, by UML diagram) the interactions, identifying the Steps where possible.

3 Auxiliary Issues

3.1 References and contacts

Documents and individuals or organizations used as background to the function described; other functions referenced by this function, or acting as “sub” functions; or other documentation that clarifies the requirements or activities described. All prior work (intellectual property of the company or individual) or proprietary (non-publicly available) work must be so noted.

ID	Title or contact	Reference or contact information
[1]	P. S. Vishwanath	Paragon Consulting Services, 301-323-4088
[2]	Joe Kelly	Paragon Consulting Services, 503-978-8289

3.2 Action Item List

As the function is developed, identify issues that still need clarification, resolution, or other notice taken of them. This can act as an Action Item list.

ID	Description	Status
[1]		
[2]		

3.3 Revision History

For reference and tracking purposes, indicate who worked on describing this function, and what aspect they undertook.

No	Date	Author	Description
0.1	December 15, 2003	P S V	

This page intentionally left blank.

Consumer Portal Scenario P7

1 Descriptions of Function

All prior work (intellectual property of the company or individual) or proprietary (non-publicly available) work should be so noted.

1.1 Function Name

Name of Function: Utility use of DERSystemControllers and load curtailment in conjunction with net-metering.

1.2 Function ID

IECSA identification number of the function

L-10, L-10.2, L-11, C-5.1

1.3 Brief Description

Describe briefly the scope, objectives, and rationale of the Function

A utility company wants to effectively use the DERSystemControllers (DER) installed in customer sites to reduce its contract power purchase during peak load periods. These customers have signed up for net-metering and there are other customers who have signed up for load curtailment during peak demand periods in return for rebates. The utility would use its internal demand projection models and communications with the DER, along with guaranteed buy-back of power agreements and curtailment of major loads during peak periods, to implement economic peak rate power purchase under its contract power purchase agreements.

1.4 Narrative

A complete narrative of the Function from a Domain Expert's point of view, describing what occurs when, why, how, and under what conditions. This will be a separate document, but will act as the basis for identifying the Steps in Section 2.

A western utility has a residential customer base of 1 million meters. The meters are installed in single-family detached housing (SFD), single-family attached housing (SFA), apartment buildings and mobile homes. The utility wishes to promote the use of renewable resources within its residential and light commercial client base.

The utility has demand relief requirements and has multiple demand response programs in place. It additionally supports active residential conservation programs as well as residential alternate, renewable and distributed generation.

The results of all of these efforts are reported to the PublicUtilityCommision as part of their requirements to receive credit in rate base.

The utility decides to incentivize the residential and light commercial use of DERSystemControllers (DER) by offering a guaranteed buy-back of power under specific conditions. The plan requires the customers to install DER with their own resources and the utility will purchase power delivered to the grid (specified in DER regulations) during periods of high demand.

Additionally the utility offers demand responsive programs wherein customers receive financial incentives for curtailing HVAC, pool pumps, and electric water heaters during peak demand periods.

A specific subset (100 total) of the customers participating in these programs resides on a congested Transmission Service Provider feeder in a specific geographic area of the service territory. Thus it's advantageous for the utility to "involve" these customers during times of peak demand or high purchase power contractual periods.

The issues confronting the utility during seasonal high demand periods are:

- They need to know which homes of the 100 have DER installed, the size of the DER (kW) and the type of DER (solar PV, generator, etc.
- They need to know which customers have signed net-metering contracts, and which customers participate in incentivized load control programs.
- They need to have access to purchase power contract pricing information

The utility enters into a typical high demand period; ambient temperatures are rising and HVAC loads are increasing. The utility has orchestrated a "smart system" approach and goes through the following procedures.

1. The utility interrogates primary line meters on the Transmission Service Provider feeder and starts to continuously monitor line loading. The utility has developed a model to assess the primary MeterDevice load ramp and can predict when the feeder will become overloaded at the monitored rate-of-change. The model predicts that at the present rate of change the line will become critical within one hour.
2. Based on this fact, the utility calls up an internal database for that specific geographic area and determines which customers have DER and how much they have (kW). Based on the database results the utility interrogates the customer portals to assess which units are already on line and which ones are available to be called up (available units must provide an "availability" signal as part of their contract with the utility).
3. The utility notifies the customers that specific DER units will be called up within 30 minutes. The DER is called on line at a specific time and the contractual buy-back rate goes into effect (the rate is guaranteed at 90% of purchase power at that time

period, with the 10% differential going into system O&M). Thus the utility is now buying DER power at 90% of a purchase power rate that is determined by calling up the utility's purchase power contracts interactive spot-power database.

4. The customers net-meters are now supplying the utility enterprise with delivered power for a prescribed time that must be credited to the customer's account and eventually show up on their monthly invoice as a credit.
5. The utility continues to monitor the primary meters and determines that the acquired DER has slowed the rate of change, but the system will still overload during the peak demand period. Thus it decides to curtail customers participating in ongoing demand reduction programs.
6. The utility interrogates the specific customers on the feeder and determines which customers have controllable loads that are in service. The utility sends out a signal that advises of an upcoming curtailment and then reads the primary MeterDevice just before the curtailment signal is sent, and 15 minutes after the curtailment signal is sent.
7. The utility determines that the peak demand problem has been averted and does not elect to purchase expensive power under contract.
8. The billing department now calculates the amount of money to re-imburse each DER participating customer based on agreed upon rates and for the measured time period.
9. The billing department calculates the amount of incentives to pay each of the participating DSM customers. Free-riders are subtracted from the customers to be rewarded as are those that overrode the event (an option of the program.)

1.5 Actor (Stakeholder) Roles

Describe all the people (their job), systems, databases, organizations, and devices involved in or affected by the Function (e.g. operators, system administrators, technicians, end users, service personnel, executives, SCADA system, real-time database, RTO, RTU, IED, power system). Typically, these actors are logically grouped by organization or functional boundaries or just for collaboration purpose of this use case. We need to identify these groupings and their relevant roles and understand the constituency. The same actor could play different roles in different Functions, but only one role in one Function. If the same actor (e.g. the same person) does play multiple roles in one Function, list these different actor-roles as separate rows.

<i>Grouping (Community)'</i>		<i>Group Description</i>
<i>Customer Site</i>		<i>Those entities that are located at customer's premises</i>
<i>Actor Name</i>	<i>Actor Type (person, device, system etc.)</i>	<i>Actor Description</i>
Customer	Person	One signed up to participate in the DERSystemController (DER) program.
CustomerCommunicationPortal	System	System handling communications function at customer's premises [in this case, communications with the installed DER, net-MeterDevice, power quality system and the utility's DER operations]
NetMeterDevice-MeterDevice	Device	Device that can measure and transmit the net flow of power to the customer [i.e., it measures power flow in both directions – into the customer premises from the utility and out to the utility from customer premises – and generates a net MeterDevice data that can be used by the utility to bill the customer accordingly]
DERSystemController	System	System at the customer site that generates power and is set up to be brought online at the demand of the utility company
Meter Device	System	System for transmitting MeterDevice data on demand to the utility.
DLCSwitchController	Device	Device performing cycling of major load, such as the air conditioning unit, pool pump heater, etc

Replicate this table for each logic group.

<i>Grouping (Community)</i>		<i>Group Description</i>
<i>Load Serving Entity DERSystemController Operations</i>		<i>Those entities that are charged with managing the DERSystemController functions for the power company to optimize the loading of the Transmission & Distribution grid</i>
<i>Actor Name</i>	<i>Actor Type (person, device, system etc.)</i>	<i>Actor Description</i>
DERSystemController	System	DERSystemController Center: System at the power company that handles DER operations [such as the system load model, decisions on when to initiate DER activities, triggering communications with other utility departments and the DER program participants, etc]
LineMeterDevice	Device	Device that measures loading of feeder line in specific Transmission Service Provider grid sectors of the utility
Transmission & Distribution Feeder	System	System that handles the Transmission Service Provider function to specific geographic sector in utility's service area.
DERDatabase	System	System that contains information about customers participating in the DER program, their location, details of their system (such as DER installed, the size of the DER (kW) and the type of DER (solar PV, generator, etc)), whether they have signed net-metering contract, and so on.
CustomerBillingSystem	System	System that handles generation of bills for the services provided to the customer
CustomerId	Device	A common customer identification key that is used by service providers authorized by the customer to identify all of their service accounts
CustomerInformationDatabase	System	System that contains information about customer accounts of the power company
DemandReductionProgramDatabase	System	Demand Reduction Program [DemandReductionProgramDatabase] Database: System that contains information about all of the Demand Reduction Programs offered by the

<i>Grouping (Community)'</i>		<i>Group Description</i>
<i>Load Serving Entity DERSystemController Operations</i>		<i>Those entities that are charged with managing the DERSystemController functions for the power company to optimize the loading of the Transmission & Distribution grid</i>
<i>Actor Name</i>	<i>Actor Type (person, device, system etc.)</i>	<i>Actor Description</i>
		utility, participation requirements, equipment details and links to customer billing system for passing incentive information
DemandResponseProgramManager	Person	Person managing the DemandReductionProgramDatabase at the utility
Purchase Power Contracts Interactive Spot-Power Spot Price Database	System	System used by the utility to track and determine the spot price of power that it can purchase under its existing contracts
LoadPredictionModel	System	System that a models feeder load by automatically tracking weather, load and other conditions to project overload events at specific feeder lines and connected to the DER database
Utility Communications Network	System	System responsible for managing communications between the utility and the participants in the DER program [for functions such as remote MeterDevice reading, controlling DER units at customer sites, monitoring net-meters and other related communications activities]

<i>Grouping (Community)'</i>		<i>Group Description</i>
<i>Others</i>		<i>Those entities that are involved in this activity, but do not fit in any of the Groupings above</i>
<i>Actor Name</i>	<i>Actor Type (person, device, system etc.)</i>	<i>Actor Description</i>
Metering	Person	Department at the utility that manages meters and their installation at the customer site
Purchasing Selling Entity	Person	Department at the utility company that handles procurement of power resources for the utility company.
PublicUtilityCommission	Person	State Public Utility Commission {PUC): The entity that receives results of the utility's demand reduction program.
Transmission Service Provider	System	Transmission & Distribution (Transmission Service Provider) Grid : System at the utility company that manages the Transmission and Distribution grid for the utility company and monitors for loading factors, etc.
Utility Communications Network	System	System responsible for managing communications between the utility and the participants in the DER program [for functions such as remote MeterDevice reading, controlling DER units at customer sites, monitoring net-meters and other related communications activities].
EnergyServiceProvider		
ServiceProvider		
Specified Loads		
MeterDevice		
Meter Device		

1.6 Information exchanged

Describe any information exchanged in this template.

<i>Information Object Name</i>	<i>Information Object Description</i>
Transmission Service Provider Feeder LineMeterDevice Query	Query from utility's DER Center to Transmission Service Provider feeder line MeterDevice to determine the potential for line overload and generating the trigger to activate the DER program in the affected segment
DER Activation Order	System order to initiate DER ahead of projected line overload, communications to the participating customers to alert the onset of DER, verifying DER availability at each customer site, bringing online selected DER at customer sites, alerting the CustomerCommunicationPortal and net-MeterDevice at each site to record delivered power and flagging the power delivered for appropriate payment by the billing system
DemandReductionProgramDatabase Implementation	System order to alert customers on DemandReductionProgramDatabase to curtail participating loads, track curtailed loads and transmit curtailment information to the system for applying credits on termination of the curtailment order
DER Order Termination	System order to terminate the DER at the customer site based on model projection of averting peak demand problem, crediting each customer for power delivered as per applicable rates, and decision on not purchasing power under contract from other sources

1.7 Activities/Services

Describe or list the activities and services involved in this Function (in the context of this Function). An activity or service can be provided by a computer system, a set of applications, or manual procedures. These activities/services should be described at an appropriate level, with the understanding that sub-activities and services should be described if they are important for operational issues, automation needs, and implementation reasons. Other sub-activities/services could be left for later analysis.

<i>Activity/Service Name</i>	<i>Activities/Services Provided</i>
Determine Potential Feeder Peak Load Problem	Based on ambient temperatures and HVAC loads crossing the threshold values, trigger a query to utility feeder load model to determine if a specific feeder line will face overload problem; if the model predicts potential overload problem, trigger activation of DER activities for that sector
Initiate DER Program Activation	Initiate actions to activate DER program activities for the targeted feeder line: query DER database to flag DER customers in the affected segment, identify amount of power (kW) available from registered DER from customers in that segment, generate a query to those customers to determine their DER system availability and generate an alert to those with available DER system to indicate potential program activation within 30 minutes
Implement DER	Activate DER systems at customers already alerted and with available systems, alert the CustomerCommunicationPortal and net-meters at those locations to record power delivered and duration of power delivery, activate PQ monitoring of delivered power to verify compliance with system requirements, drop non-complying units from the grid and flag for notice after the event, track feeder load to determine timing for program termination and hold-off contract power purchase on spot market during the DER program period
Implement DemandReductionProgramDatabase	On indication by the power model to initiate load shedding, contact customers participating in the DemandReductionProgramDatabase to alert them about load curtailment in 15 minutes, curtail specified loads, monitor the duration and load curtailed, and continue the curtailment till system requests termination of the DemandReductionProgramDatabase event
Terminate DER and DemandReductionProgramDatabase	On indication by the power model of the end of the projected overload problem for the feeder line, send out a trigger to customer DER systems supplying power to terminate operation, record power supplied and duration of power supply, send out trigger to DemandReductionProgramDatabase customers to turn on curtailed load, finalize decision not to buy power under spot-market purchase contract and revert system back to monitoring mode for next overload situation
Complete Post-DER and DemandReductionProgramDatabase Program Activities	Initiate actions to transmit net-metering data to billing to generate credit to customers for the power supplied at the contractual buy-back rate, transmit curtailed load and curtailment duration for participating DemandReductionProgramDatabase customers to the billing system for applying applicable incentive credits, and notify all customers in the DER program and DemandReductionProgramDatabase

<i>Activity/Service Name</i>	<i>Activities/Services Provided</i>
	that the current DER and DemandReductionProgramDatabase event has been successfully terminated

1.8 Contracts/Regulations

Identify any overall (human-initiated) contracts, regulations, policies, financial considerations, engineering constraints, pollution constraints, and other environmental quality issues that affect the design and requirements of the Function.

<i>Contract/Regulation</i>	<i>Impact of Contract/Regulation on Function</i>
DER Program Tariffs	Specifications of DER equipment installed at customer site, net-metering equipment at customer site, contractual buy-back rates, PQ acceptance criteria and power supply credits applied to customer bill
Demand Reduction Program Tariffs	Equipment installed at customer site, cycling regime implemented and incentive rewards applied to customer bill

<i>Policy</i>	<i>From Actor</i>	<i>May</i>	<i>Shall Not</i>	<i>Shall</i>	<i>Description (verb)</i>	<i>To Actor</i>
Install DER Equipment	Customer			X	Customer needs to install DER system at site to participate in the program	EnergyServiceProvider
Install NetMeterDevice-Meter	EnergyServiceProvider			X	Install specified net-metering equipment at customer site	Customer
Activate DER	EnergyServiceProvider	X			Activate and bring online customer's DER	Customer
Participate in DemandReductionProgramDatabase	Customer	X			Customer needs to agree to participate in the DemandReductionProgramDatabase and permit the utility to curtail specified loads during peak demand periods	EnergyServiceProvider
Buy-back Power During DER Event	EnergyServiceProvider			X	Utility shall buy-back power at contract rates from customer's DER during a DER event if the customer's delivered power meets PQ criteria	Customer

Cycle Energy to Equipment	EnergyServiceProvider	X			Cycle power to air conditioning unit on utility trigger	Specified Loads
Provide Load Control Equipment	ServiceProvider			X	Install specified equipment at customer site	Customer
Provide Incentive Rewards	EnergyServiceProvider			X	Provide incentive reward on customer energy bill	Customer

<i>Constraint</i>	<i>Type</i>	<i>Description</i>	<i>Applies to</i>
<i>Program Participation</i>	<i>System Availability</i>	<i>A customer can participate in a given DER event only if the DER system is in “available” state</i>	<i>Selecting customer for DER participation</i>
<i>Load Curtailment</i>	<i>Turn Off Loads</i>	<i>Customer to permit specified major loads [such as HVAC, Pool Pump, etc] to be turned off by the utility</i>	<i>Customer’s eligibility for participation in the program to receive incentives</i>
<i>Reward Period</i>	<i>Inactive</i>	<i>Months of the year when the program is not active [i.e., non-summer months for this program]</i>	<i>No incentive reward provided</i>
<i>Energy Usage</i>	<i>Minimum Threshold</i>	<i>Tracked energy usage to meet or exceed program requirements to qualify to participate in the program and receive incentive reward on bill</i>	<i>Eligibility to continue participation in the program</i>
<i>Power Buy-back</i>	<i>Buy-back Rate</i>	<i>On DER program activation and customer DER meeting availability criteria, the utility is obligated to buy-back power at 90% purchased power rate at that time</i>	<i>Rate paid by the utility to customer for power delivered to the grid</i>

2 Step by Step Analysis of Function

Describe steps that implement the function. If there is more than one set of steps that are relevant, make a copy of the following section grouping (Preconditions and Assumptions, Steps normal sequence, and Steps alternate or exceptional sequence, Post conditions)

2.1 Steps to implement function

Name of this sequence.

2.1.1 Preconditions and Assumptions

Describe conditions that must exist prior to the initiation of the Function, such as prior state of the actors and activities

Identify any assumptions, such as what systems already exist, what contractual relations exist, and what configurations of systems are probably in place

Identify any initial states of information exchanged in the steps in the next section. For example, if a purchase order is exchanged in an activity, its precondition to the activity might be 'filled in but unapproved'.

<i>Actor/System/Information/Contract</i>	<i>Preconditions or Assumptions</i>
DER Equipment	Assumes that the customer has installed DER equipment that will be made available to utility on demand
DER Program tariff	Assumes that a tariff exists with details of program requirements and buy-back rates that the customer can sign up
DERDatabase	Assumes that the utility has a database with customer DER information keyed to feeder and geographic information
CustomerCommunicationPortal	Assumes that the CustomerCommunicationPortal is installed in the customer location that will permit communications with the customer and DER equipment, enable communication with DLC and specified loads to implement curtailment and permit monitoring of curtailed

<i>Actor/System/Information/Contract</i>	<i>Preconditions or Assumptions</i>
	loads
NetMeterDevice	Assumes a net-MeterDevice has been installed at customer site to monitor power delivery to the grid
Feeder LoadPredictionModel	Assumes that a model is available to the utility to automatically track weather, load and other conditions to project overload events at specific feeder lines and connected to the DER database
CustomerId	Assumes that a common customer id is used by the customer service, Demand Reduction Program, DER and billing departments
Demand Reduction Program tariff	Assumes that a tariff exists with details of program requirements and incentive rewards that the customer can sign up

2.1.2 Steps – Normal Sequence

Describe the normal sequence of events, focusing on steps that identify new types of information or new information exchanges or new interface issues to address. Should the sequence require detailed steps that are also used by other functions, consider creating a new “sub” function, then referring to that “subroutine” in this function. Remember that the focus should be less on the algorithms of the applications and more on the interactions and information flows between “entities”, e.g. people, systems, applications, data bases, etc. There should be a direct link between the narrative and these steps.

The numbering of the sequence steps conveys the order and concurrency and iteration of the steps occur. Using a Dewey Decimal scheme, each level of nested procedure call is separated by a dot ‘.’. Within a level, the sequence number comprises an optional letter and an integer number. The letter specifies a concurrent sequence within the next higher level; all letter sequences are concurrent with other letter sequences. The number specifies the sequencing of messages in a given letter sequence. The absence of a letter is treated as a default ‘main sequence’ in parallel with the lettered sequences.

Sequence 1:

*1.1 - Do step 1
1.2A.1 - In parallel to activity 2 B do step 1
1.2A.2 - In parallel to activity 2 B do step 2
1.2B.1 - In parallel to activity 2 A do step 1
1.2B.2 - In parallel to activity 2 A do step 2
1.3 - Do step 3
1.3.1 - nested step 3.1
1.3.2 - nested step 3.2*

Sequence 2:

*2.1 - Do step 1
2.2 - Do step 2*

#	Event	Primary Actor	Name of Process/Activity	Description of Process/Activity	Information Producer	Information Receiver	Name of Info Exchanged	Additional Notes	IECSA Environments
#	<i>Triggering event? Identify the name of the event.¹</i>	<i>What other actors are primarily responsible for the Process/Activity? Actors are defined in section0.</i>	<i>Label that would appear in a process diagram. Use action verbs when naming activity.</i>	<i>Describe the actions that take place in active and present tense. The step should be a descriptive noun/verb phrase that portrays an outline summary of the step. "If ...Then...Else" scenarios can be captured as multiple Actions or as separate steps.</i>	<i>What other actors are primarily responsible for Producing the information? Actors are defined in section0.</i>	<i>What other actors are primarily responsible for Receiving the information? Actors are defined in section0. (Note – May leave blank if same as Primary Actor)</i>	<i>Name of the information object. Information objects are defined in section 1.6</i>	<i>Elaborate architectural issues using attached spreadsheet. Use this column to elaborate details that aren't captured in the spreadsheet.</i>	<i>Reference the applicable IECSA Environment containing this data exchange. Only one environment per step.</i>
1.1	Transmission Service Provider Feeder LineMeterDevice Query	DERSystem Controller	Demand data and HVAC load data	DER system receives ambient temperature, demand data and HVAC load data	Utility Transmission Service Provider data	DERSystemC ontroller	Ambient temperature and load data exceeding specified threshold values		DER Monitoring and Control
1.2		DERSystem Controller	Check feeder overload projection	DER system queries utility's load prediction model	DERSystemC ontroller	LoadPredictio nModel	System data for use by the model		DER Monitoring and Control
1.3		LoadPredict ionModel	Identifies line at risk of overload	Load prediction model identifies feeder line at risk of overload event	LoadPredictio nModel	DERSystemC ontroller	Information identifying feeder at risk		DER Monitoring and Control
1.4	Identifies feeder line at risk of overload	DERSystem Controller	Activates DER program for identified feeder line	DER system generates trigger to activate DER program for the identified feeder line	DERSystemC ontroller	DERDatabase	Activation trigger for DER program activities		DER Monitoring and Control
2.1	DER and	DERSystem	DER system	DER system queries	DERSystemC	DERSystemC	Amount and		DER

¹ Note – A triggering event is not necessary if the completion of the prior step – leads to the transition of the following step.

#	Event	Primary Actor	Name of Process/Activity	Description of Process/Activity	Information Producer	Information Receiver	Name of Info Exchanged	Additional Notes	IECSA Environments
	DemandReductionProgram Database Activation Order	Controller	determines DER capacity	DER database to determine power capacity from customers in the affected segment	ontroller, Transmission Service Provider system, DERDatabase	ontroller	types of power that can be obtained from the customers participating in the DER program		Monitoring and Control
2.1.1		DERSystem Controller	Actual available power from the targeted customers	DER system signals identified customers to determine availability	DERSystemC ontroller, CustomerCo mmunication Portal, DERSystemC ontroller	DERSystemC ontroller	Actual available power from the targeted customers		DER Monitoring and Control
2.1.2	DER systems signals to check for availability	DERSystem Controller	Activation alert to customers on pending program activation	DER system alerts customers with available power on system activation in 30 minutes	DERSystemC ontroller	CustomerCo mmunication Portal, DERSystemC ontroller	Activation alert to customers on pending program activation		DER Monitoring and Control
2.2		DERSystem Controller	Signal to turn on DER equipment at available customer sites	DER system turns on DER equipment at targeted customers' sites	DERSystemC ontroller	CustomerCo mmunication Portal, DERSystemC ontroller	Signal to turn on DER equipment at available customer sites		DER Monitoring and Control
2.3		DERSystem Controller	Record energy delivered to the grid	Alert CustomerCommunicationPortal at conforming DER customers to record power delivery	DERSystemC ontroller	CustomerCo mmunication Portal, Customer NetMeterDev	Information on amount of power and duration of power delivered to the grid		DER Monitoring and Control

#	Event	Primary Actor	Name of Process/Activity	Description of Process/Activity	Information Producer	Information Receiver	Name of Info Exchanged	Additional Notes	IECSA Environments
						ice-MeterDevice			
2.4		DERSystem Controller	Delay buying power on spot-market	Signal Purchasing Selling Entity to delay spot-market power purchase	DERSystemC ontroller	Purchasing Selling Entity	Delay buying decision for power purchase on spot-market		DER Monitoring and Control
2.5		DERSystem Controller	Determine contract power buy-back rate	Query utility's spot-market power database to determine contract power rate	Purchase Power Contracts Interactive Spot-Power Spot Price Database -	DERSystemC ontroller, DERDatabase , CustomerBilli ngSystem	Power buy-back rate applicable to power from customer DER to utility grid		DER Monitoring and Control
2.6		DERSystem Controller	On-going tracking feeder overload	On-going tracking feeder overload condition and load prediction model	LoadPredictio nModel and Transmission Service Provider Grid	DERSystemC ontroller	Status data indicating the need for DER power from customers		DER Monitoring and Control
2.7		DERSystem Controller	Identify DemandReduc tionProgramDa tabase participating customers	Generate query to DemandReductionProg ramDatabase Database to identify participating customers in the affected grid line	DemandRedu ctionProgram Database	DERSystemC ontroller	List of customers participating in the DemandReducti onProgramDatab ase load curtailment program		DER Monitoring and Control
2.7.1		DERSystem Controller	Trigger DemandReduc tionProgramDa tabase load	Trigger DemandReductionProg ramDatabase load curtailment alert signal	DemandRedu ctionProgram Database	CustomerCo mmunication Portal and DLCSwitchC	Signal alerting identified customers of load curtailment		DER Monitoring and Control

#	Event	Primary Actor	Name of Process/Activity	Description of Process/Activity	Information Producer	Information Receiver	Name of Info Exchanged	Additional Notes	IECSA Environments
			curtailment alert	to participating DemandReductionProgramDatabase customers		ontroller			
2.7.2	Trigger DemandReductionProgramDatabase load curtailment alert	DERSystemController	Monitor load curtailment	Monitor load curtailment in progress [to ensure customer has not chosen to override the curtailment]	DemandReductionProgramDatabase	CustomerCommunicationPortal, DLCSwitchController and MeterDevice	Verify load curtailment for the duration of the event		DER Monitoring and Control
2.7.3		DERSystemController	Record of curtailment at details at customer site	Alert CustomerCommunicationPortal to record duration and details of load curtailed	CustomerCommunicationPortal	MeterDevice and DLCSwitchController	Record of curtailment at details at customer site		DER Monitoring and Control
3.1	Monitor T&D data	DERSystemController	Predict if DER program and DemandReductionProgramDatabase can be terminated	LoadPredictionModel and T &D data indicate DER and DemandReductionProgramDatabase activation can be terminated	LoadPredictionModel and Transmission Service Provider Grid	DERSystemController	Trigger to initiate DER event termination		DER Monitoring and Control
3.2	DER program and DemandReductionProgramDatabase can be terminated	DERSystemController	DERSystemController initiates termination sequencing	DERSystemController initiates orderly sequencing DER program and DemandReductionProgramDatabase event termination	DERSystemController, DERDatabase	CustomerCommunicationPortal, DERSystemController	Message to customer DER unit on shutdown schedule		DER Monitoring and Control
3.2.		DERSystem	Transmit DER	Transmit DER turn-off	DERSystemC	CustomerCo	Signal to		DER

#	Event	Primary Actor	Name of Process/Activity	Description of Process/Activity	Information Producer	Information Receiver	Name of Info Exchanged	Additional Notes	IECSA Environments
1		Controller	turn-off signal	signal to each customer as per the schedule	Controller	Communication Portal, DERSystemController	individual DER unit to terminate power delivery		Monitoring and Control
3.2.1.1	Transmit DER turn-off signal	DERSystemController	Confirmation of power delivery turn-off	Confirmation by customer unit of power delivery termination	CustomerCommunication Portal, DERSystemController	DERSystemController	Positive acknowledgment of system turn-off		DER Monitoring and Control
3.2.2	Transmit DemandReductionProgram Database Order Termination	DERSystemController	Transmit signal to turn on curtailed loads	Transmit signal to turn on curtailed loads to participating customers	DemandReductionProgram Database	CustomerCommunication Portal, DLCSwitchController	Signal to terminate load curtailment activity		DER Monitoring and Control
3.2.2.1	Transmit signal to turn on curtailed loads	DERSystemController	Confirmation of load curtailment	Confirmation of customer of terminating load curtailment	CustomerCommunication Portal	DERSystemController	Positive acknowledgment of DemandReductionProgram Database event termination		DER Monitoring and Control
3.3		DERSystemController	Power delivered during DER event	Customer site transmits net power delivery during DER event	CustomerCommunication Portal, CustomerNetMeterDevice-MeterDevice	DERDatabase	Details of amount of power delivered, duration of power delivered during the DER event		DER Monitoring and Control

#	Event	Primary Actor	Name of Process/Activity	Description of Process/Activity	Information Producer	Information Receiver	Name of Info Exchanged	Additional Notes	IECSA Environments
3.3.1		DERSystem Controller	Generate power delivery and rate information	Delivered power information and applicable rate data sent to billing system	DERSystem Controller, DERDatabase	CustomerBillingSystem	Amount and details of credit to be issued to customer for power delivered during the DER event		DER Monitoring and Control
3.3.1.1		DERSystem Controller	Amount of power purchase avoided due to DER program	Delivered power by customer DER units and peak load averted data to Purchasing Selling Entity	DERDatabase	Purchasing Selling Entity	Amount of power purchase avoided due to DER program activation		DER Monitoring and Control
3.4	DemandReductionProgram Database Event	DERSystem Controller	Customer site transmits DemandReductionProgramDatabase event data	Customer site transmits curtailed load data during the DemandReductionProgramDatabase event	CustomerCommunication Portal, Meter Device	DemandReductionProgram Database	Details of loads curtailed, duration of curtailment, and amount of power consumption saved		DER Monitoring and Control
3.4.1		DERSystem Controller	Customer site transmits DemandReductionProgramDatabase event data for billing	Curtailed load and duration information to billing system	DemandReductionProgram Database	CustomerBillingSystem	Amount of credits to be applied to customer for load curtailed during the DemandReductionProgramDatabase event		DER Monitoring and Control
3.4.1.1		DERSystem Controller	Amount of power	Peak load demand averted data to	DemandReductionProgram	Purchasing Selling Entity	Amount of power purchase		DER Monitoring

#	Event	Primary Actor	Name of Process/Activity	Description of Process/Activity	Information Producer	Information Receiver	Name of Info Exchanged	Additional Notes	IECSA Environments
			purchase avoided due to DemandReductionProgramDatabase activation	Purchasing Selling Entity	Database		avoided due to DemandReductionProgramDatabase activation		and Control
3.4.2		DERSystem Controller	Signal no additional DER power to be purchased	Signal Purchasing Selling Entity that no additional power needs to be purchased	DERSystemController	Purchasing Selling Entity	Finalize decision not to purchase power in spot-power market		DER Monitoring and Control
3.5	DER and DemandReductionProgramDatabase event	DERSystem Controller	Get credit for DER and DemandReductionProgramDatabase from PublicUtilityCommission	Submit total load averted [from DER program and DemandReductionProgramDatabase activities] to PublicUtilityCommission for awarding rate credits	DERSystemController, DemandReductionProgramDatabase	PublicUtility Commission	Details of power load averted due to the DER Program and DER activities		DER Monitoring and Control

2.1.3 Steps – Alternative / Exception Sequences

Describe any alternative or exception sequences that may be required that deviate from the normal course of activities. Note instructions are found in previous table.

#	Event	Primary Actor	Name of Process/Activity	Description of Process/Activity	Information Producer	Information Receiver	Name of Info Exchanged	Additional Notes	IECSA Environments

#	Event	Primary Actor	Name of Process/Activity	Description of Process/Activity	Information Producer	Information Receiver	Name of Info Exchanged	Additional Notes	IECSA Environments

2.1.4 Post-conditions and Significant Results

Describe conditions that must exist at the conclusion of the Function. Identify significant items similar to that in the preconditions section.

Describe any significant results from the Function

<i>Actor/Activity</i>	<i>Post-conditions Description and Results</i>
Consumer	System status information, credit based on net-metered power delivery on next bill and incentive rebates based on load curtailed
Transmission Service Provider Grid	Satisfactory operation having avoided peak demand load event
DERDatabase	Updated with customer DER units that delivered power, and details of power delivery (amount, duration and net-metered amount) during the DER event
Billing system database	Updated with credit to be issued to participating customers for power delivered as per applicable contract rates (90% of contracted spot-market power rates) during the DER event and rebates to be issued to participating customers for loads curtailed during the DemandReductionProgramDatabase implementation
Customer DER Equipment	Updated with status after the DER event
Purchasing Selling Entity	Avoided purchase of power in spot-power market and details of the amount of power purchase avoided
LoadPredictionModel	Updated with actual system performance during the DER/DemandReductionProgramDatabase event for refining future projections

2.2 Architectural Issues in Interactions

Elaborate on all architectural issues in each of the steps outlined in each of the sequences above. Reference the Step by number..

2.3 Diagram

For clarification, draw (by hand, by Power Point, by UML diagram) the interactions, identifying the Steps where possible.

3 Auxiliary Issues

3.1 References and contacts

Documents and individuals or organizations used as background to the function described; other functions referenced by this function, or acting as “sub” functions; or other documentation that clarifies the requirements or activities described. All prior work (intellectual property of the company or individual) or proprietary (non-publicly available) work must be so noted.

ID	Title or contact	Reference or contact information
[1]	P. S. Vishwanath	Paragon Consulting Services, 301-323-4088
[2]	Joe Kelly	Paragon Consulting Services, 503-978-8289

3.2 Action Item List

As the function is developed, identify issues that still need clarification, resolution, or other notice taken of them. This can act as an Action Item list.

ID	Description	Status
[1]		
[2]		

3.3 Revision History

For reference and tracking purposes, indicate who worked on describing this function, and what aspect they undertook.

No	Date	Author	Description
0.1	December 22, 2003	P S V	First draft
0.2	December 30, 2003	P S V	Revisions and updates to missing sections

This page intentionally left blank.

Consumer Portal Scenario P8

1 Descriptions of Function

All prior work (intellectual property of the company or individual) or proprietary (non-publicly available) work should be so noted.

1.1 Function Name

Name of Function: Utility use of DERSystemControllers in conjunction with net-metering and Power Quality.

1.2 Function ID

IECSA identification number of the function

L-11, C-9.2, C-9.3

1.3 Brief Description

Describe briefly the scope, objectives, and rationale of the Function

A utility company wants to effectively use the DERSystemControllers (DER) installed in customer sites to reduce its contract power purchase during peak load periods. These customers have signed up for net-metering and agreed to meet specified Power Quality (PQ) criteria. The utility would use its internal demand projection models and communications with the DER, along with guaranteed buy-back of power agreements, to implement economic peak rate power purchase under its contract power purchase agreements.

1.4 Narrative

A complete narrative of the Function from a Domain Expert's point of view, describing what occurs when, why, how, and under what conditions. This will be a separate document, but will act as the basis for identifying the Steps in Section 2.

A western utility has a residential customer base of 1 million meters. The meters are installed in single-family detached housing (SFD), single-family attached housing (SFA), apartment buildings and mobile homes. The utility wishes to promote the use of renewable resources within its residential and light commercial client base.

The utility decides to incentivize the residential and light commercial use of DERSystemControllers (DER) by offering a guaranteed buy-back of power under specific conditions. The plan requires the customers to install DER with their own resources and the utility will purchase power delivered to the grid (specified in DER regulations) during periods of high demand.

A specific subset (100 total) of the customers participating in the DER program resides on a congested T & D feeder in a specific geographic area of the service territory. Thus it's advantageous for the utility to "involve" these customers during times of peak demand or high purchase power contractual periods.

The issues confronting the utility during seasonal high demand periods are:

- They need to know which homes of the 100 have DER installed, the size of the DER (kW) and the type of DER (solar PV, generator, etc).
- They need to know which customers have signed net-metering contracts.

The utility enters into a typical high demand period; ambient temperatures are rising and HVAC loads are increasing. The utility desires to call up DER. and goes through the following procedures:

1. The utility interrogates primary line meters on the T & D feeder and starts to continuously monitor line loading. The utility has developed a model to assess the primary MeterDevice load ramp and can predict when the feeder will become overloaded at the monitored rate-of-change. The model predicts that at the present rate of change the line will become critical within one hour.
2. Based on this fact, the utility calls up an internal database for that specific geographic area and determines which customers have DER and how much power (kW) they have. Based on the database results, the utility interrogates the customer portals to assess which units are already on line and which ones are available to be called up (available units must provide an "availability" signal as part of their contract with the utility).
3. The utility notifies the customers that specific DER units will be called up within 30 minutes. The DER is brought on line at a specific time and the contractual buy-back rate goes into effect (the rate is guaranteed at 90% of purchase power at that time period, with the 10% differential going into system O & M). Thus the utility is now buying DER power at 90% of a purchase power rate that is determined by calling up the utility's purchase power contracts interactive spot-power database.
4. The utility Power Quality group examines each customer's DER to insure that the output is within the contractual standards for Power Quality. Units not complying are dropped from the line within 500 milliseconds and a notation is made as to why the unit(s) was dropped.
5. The remaining customers' net-meters are now supplying the utility enterprise with delivered power for a prescribed time that must be credited to the customers' accounts and eventually show up on their monthly invoice as a credit.
6. The utility determines that the peak demand problem has been averted and does not elect to purchase expensive power under contract.
7. The billing department now calculates the amount of money to re-imburse each DER participating customer based on agreed upon rates [see Step 3 above] and for the measured time period.
8. The Power Quality department notifies the DER customers that failed PQ monitoring, the reason why and requests repairs to permit continued participation in the net-metering/DER program.

1.5 Actor (Stakeholder) Roles

Describe all the people (their job), systems, databases, organizations, and devices involved in or affected by the Function (e.g. operators, system administrators, technicians, end users, service personnel, executives, SCADA system, real-time database, RTO, RTU, IED, power system). Typically, these actors are logically grouped by organization or functional boundaries or just for collaboration purpose of this use case. We need to identify these groupings and their relevant roles and understand the constituency. The same actor could play different roles in different Functions, but only one role in one Function. If the same actor (e.g. the same person) does play multiple roles in one Function, list these different actor-roles as separate rows.

<i>Grouping (Community)'</i>		<i>Group Description</i>
<i>Customer Site</i>		<i>Those entities that are located at customer's premises</i>
<i>Actor Name</i>	<i>Actor Type (person, device, system etc.)</i>	<i>Actor Description</i>
Customer	Person	One signed up to participate in the DERSystemController (DER) program.
CustomerCommunicationPortal	System	System handling communications function at customer's premises [in this case, communications with the installed DER, net-MeterDevice, power quality system and the utility's DER operations]
NetMeterDevice-MeterDevice	Device	Device that can measure and transmit the net flow of power to the customer [i.e., it measures power flow in both directions – into the customer premises from the utility and out to the utility from customer premises – and generates a net MeterDevice data that can be used by the utility to bill the customer accordingly]
DERSystemController	System	System at the customer site that generates power and is set up to be brought online at the demand of the utility company
RemoteMeterDevice	System	System for transmitting MeterDevice data on demand to the utility.

Replicate this table for each logic group.

<i>Grouping (Community)</i>		<i>Group Description</i>
<i>Power Company DERSystemController Operations</i>		<i>Those entities that are charged with managing the DERSystemController functions for the power company to optimize the loading of the Transmission & Distribution grid</i>
<i>Actor Name</i>	<i>Actor Type (person, device, system etc.)</i>	<i>Actor Description</i>
DERSystemController	System	DERSystemController Center: System at the power company that handles DER operations [such as the system load model, decisions on when to initiate DER activities, triggering communications with other utility departments and the DER program participants, etc]
LineMeterDevice	Device	Device that measures loading of feeder line in specific T & D grid sectors of the utility
Transmission & Distribution Feeder	System	System that handles the T & D function to specific geographic sector in utility's service area.
DERDatabase	System	System that contains information about customers participating in the DER program, their location, details of their system (such as DER installed, the size of the DER (kW) and the type of DER (solar PV, generator, etc)), whether they have signed net-metering contract, and so on.
CustomerBillingSystem	System	System that handles generation of bills for the services provided to the customer
PQMonitoringSystem	System	Power Quality Monitoring System: System that monitors the operation and the power quality of the power generated by customer's DER to qualify it for transmission on to utility's grid
Purchase Power Contracts Interactive Spot-Power Database	System	System used by the utility to track and determine the spot price of power that it can purchase under its existing contracts

<i>Grouping (Community)'</i>		<i>Group Description</i>
<i>Power Company DERSystemController Operations</i>		<i>Those entities that are charged with managing the DERSystemController functions for the power company to optimize the loading of the Transmission & Distribution grid</i>
<i>Actor Name</i>	<i>Actor Type (person, device, system etc.)</i>	<i>Actor Description</i>
LoadPredictionModel	System	System that a models feeder load by automatically tracking weather, load and other conditions to project overload events at specific feeder lines and connected to the DER database
Utility Communications Network	System	System responsible for managing communications between the utility and the participants in the DER program [for functions such as remote MeterDevice reading, controlling DER units at customer sites, monitoring net-meters and other related communications activities]

<i>Grouping (Community)'</i>		<i>Group Description</i>
<i>Others</i>		<i>Those entities that are involved in this activity, but do not fit in any of the Groupings above</i>
<i>Actor Name</i>	<i>Actor Type (person, device, system etc.)</i>	<i>Actor Description</i>
Metering	Person	Department at the utility that manages meters and their installation at the customer site
Purchasing Selling Entity	Person	Department at the utility company that handles procurement of power resources for the utility company.
T & D	System	Transmission & Distribution (T & D) Grid : System at the utility company that manages the Transmission and Distribution grid for the utility company and monitors

<i>Grouping (Community)'</i>		<i>Group Description</i>
<i>Others</i>		<i>Those entities that are involved in this activity, but do not fit in any of the Groupings above</i>
<i>Actor Name</i>	<i>Actor Type (person, device, system etc.)</i>	<i>Actor Description</i>
		for loading factors, etc.
Utility Communications Network	System	System responsible for managing communications between the utility and the participants in the DER program [for functions such as remote MeterDevice reading, controlling DER units at customer sites, monitoring net-meters and other related communications activities].
EnergyServiceProvider		

1.6 Information exchanged

Describe any information exchanged in this template.

<i>Information Object Name</i>	<i>Information Object Description</i>
T & D Feeder LineMeterDevice Query	Query from utility's DER Center to T & D feeder line MeterDevice to determine the potential for line overload and generating the trigger to activate the DER program in the affected segment
DER Activation Order	System order to initiate DER ahead of projected line overload, communications to the participating customers to alert the onset of DER, verifying DER availability at each customer site, bringing online selected DER at customer sites, monitoring the PQ at each site, alerting the CustomerCommunicationPortal and net-MeterDevice at each site to record delivered power and flagging the power delivered for appropriate payment by the billing system

<i>Information Object Name</i>	<i>Information Object Description</i>
DER Order Termination	System order to terminate the DER at the customer site based on model projection of averting peak demand problem, crediting each customer for power delivered as per applicable rates, decision on not purchasing power under contract from other sources and alerting customers whose DER failed to meet applicable PQ criteria

1.7 Activities/Services

Describe or list the activities and services involved in this Function (in the context of this Function). An activity or service can be provided by a computer system, a set of applications, or manual procedures. These activities/services should be described at an appropriate level, with the understanding that sub-activities and services should be described if they are important for operational issues, automation needs, and implementation reasons. Other sub-activities/services could be left for later analysis.

<i>Activity/Service Name</i>	<i>Activities/Services Provided</i>
Determine Potential Feeder Peak Load Problem	Based on ambient temperatures and HVAC loads crossing the threshold values, trigger a query to utility feeder load model to determine if a specific feeder line will face overload problem; if the model predicts potential overload problem, trigger activation of DER activities for that sector
Initiate DER Program Activation	Initiate actions to activate DER program activities for the targeted feeder line: query DER database to flag DER customers in the affected segment, identify amount of power (kW) available from registered DER from customers in that segment, generate a query to those customers to determine their DER system availability and generate an alert to those with available DER system to indicate potential program activation within 30 minutes
Implement DER	Activate DER systems at customers already alerted and with available systems, alert the CustomerCommunicationPortal and net-meters at those locations to record power delivered and duration of power delivery, activate PQ monitoring of delivered power to verify compliance with system requirements, drop non-complying units from the grid and flag for notice after the event, track feeder load to determine timing for program termination and hold-off contract power purchase on spot market during the DER program period
Terminate DER	On indication by the power model of the end of the projected overload problem for the feeder line, send out a trigger to customer DER systems supplying power to terminate operation, record power supplied

<i>Activity/Service Name</i>	<i>Activities/Services Provided</i>
	and duration of power supply, finalize decision not to buy power under spot-market purchase contract and revert system back to monitoring mode for next overload situation
Complete Post-DER Activities	Initiate actions to transmit net-metering data to billing to generate credit to customers for the power supplied at the contractual buy-back rate, generate an alert to customers whose DER systems failed to meet prescribed PQ criteria and notify all customers in the DER program that the current DER event has been successfully terminated

1.8 Contracts/Regulations

Identify any overall (human-initiated) contracts, regulations, policies, financial considerations, engineering constraints, pollution constraints, and other environmental quality issues that affect the design and requirements of the Function.

<i>Contract/Regulation</i>	<i>Impact of Contract/Regulation on Function</i>
DER Program Tariffs	Specifications of DER equipment installed at customer site, net-metering equipment at customer site, contractual buy-back rates, PQ acceptance criteria and power supply credits applied to customer bill

<i>Policy</i>	<i>From Actor</i>	<i>May</i>	<i>Shall Not</i>	<i>Shall</i>	<i>Description (verb)</i>	<i>To Actor</i>
Install DER Equipment	Customer			X	Customer needs to install DER system at site to participate in the program	EnergyServiceProvider
Install NetMeterDevice-Meter	EnergyServiceProvider			X	Install specified net-metering equipment at customer site	Customer
Activate DER	EnergyServiceProvider	X			Activate and bring online customer's DER	Customer
Meet PQ Criteria	Customer			X	Customer shall maintain the DER system in a manner that will ensure that the DER meets specified PQ criteria for power delivery	EnergyServiceProvider

Buy-back Power During DER Event	EnergyServiceProvider			X	Utility shall buy-back power at contract rates from customer's DER during a DER event if the customer's delivered power meets PQ criteria	Customer
---------------------------------	-----------------------	--	--	---	---	----------

<i>Constraint</i>	<i>Type</i>	<i>Description</i>	<i>Applies to</i>
<i>Program Participation</i>	<i>System Availability</i>	<i>A customer can participate in a given DER event only if the DER system is in "available" state</i>	<i>Selecting customer for DER participation</i>
<i>Power Delivery</i>	<i>PQ</i>	<i>Customer's DER unit to meet specified PQ criteria to be permitted to deliver power to the utility</i>	<i>Acceptance of power from customer's DER and eligibility to continue participation in the program</i>
<i>Power Buy-back</i>	<i>Buy-back Rate</i>	<i>On DER program activation and customer DER meeting availability and PQ criteria, the utility is obligated to buy-back power at 90% purchased power rate at that time</i>	<i>Rate paid by the utility to customer for power delivered to the grid</i>

2 Step by Step Analysis of Function

Describe steps that implement the function. If there is more than one set of steps that are relevant, make a copy of the following section grouping (Preconditions and Assumptions, Steps normal sequence, and Steps alternate or exceptional sequence, Post conditions)

2.1 Steps to implement function

Name of this sequence.

2.1.1 Preconditions and Assumptions

Describe conditions that must exist prior to the initiation of the Function, such as prior state of the actors and activities

Identify any assumptions, such as what systems already exist, what contractual relations exist, and what configurations of systems are probably in place

Identify any initial states of information exchanged in the steps in the next section. For example, if a purchase order is exchanged in an activity, its precondition to the activity might be 'filled in but unapproved'.

<i>Actor/System/Information/Contract</i>	<i>Preconditions or Assumptions</i>
DER Equipment	Assumes that the customer has installed DER equipment that will be made available to utility on demand
DER Program tariff	Assumes that a tariff exists with details of program requirements and buy-back rates that the customer can sign up
DERDatabase	Assumes that the utility has a database with customer DER information keyed to feeder and geographic information
CustomerCommunicationPortal	Assumes that the CustomerCommunicationPortal is installed in the customer location that will permit communications with the customer and DER equipment

<i>Actor/System/Information/Contract</i>	<i>Preconditions or Assumptions</i>
NetMeterDevice	Assumes a net-MeterDevice has been installed at customer site to monitor power delivery to the grid
Feeder LoadPredictionModel	Assumes that a model is available to the utility to automatically track weather, load and other conditions to project overload events at specific feeder lines and connected to the DER database

2.1.2 Steps – Normal Sequence

Describe the normal sequence of events, focusing on steps that identify new types of information or new information exchanges or new interface issues to address. Should the sequence require detailed steps that are also used by other functions, consider creating a new “sub” function, then referring to that “subroutine” in this function. Remember that the focus should be less on the algorithms of the applications and more on the interactions and information flows between “entities”, e.g. people, systems, applications, data bases, etc. There should be a direct link between the narrative and these steps.

The numbering of the sequence steps conveys the order and concurrency and iteration of the steps occur. Using a Dewey Decimal scheme, each level of nested procedure call is separated by a dot ‘.’. Within a level, the sequence number comprises an optional letter and an integer number. The letter specifies a concurrent sequence within the next higher level; all letter sequences are concurrent with other letter sequences. The number specifies the sequencing of messages in a given letter sequence. The absence of a letter is treated as a default ‘main sequence’ in parallel with the lettered sequences.

Sequence 1:

*1.1 - Do step 1
1.2A.1 - In parallel to activity 2 B do step 1
1.2A.2 - In parallel to activity 2 B do step 2
1.2B.1 - In parallel to activity 2 A do step 1
1.2B.2 - In parallel to activity 2 A do step 2
1.3 - Do step 3
1.3.1 - nested step 3.1
1.3.2 - nested step 3.2*

Sequence 2:

*2.1 - Do step 1
2.2 - Do step 2*

#	Event	Primary Actor	Name of Process/Activity	Description of Process/Activity	Information Producer	Information Receiver	Name of Info Exchanged	Additional Notes	IECSA Environments
#	<i>Triggering event? Identify the name of the event.¹</i>	<i>What other actors are primarily responsible for the Process/Activity? Actors are defined in section1.5.</i>	<i>Label that would appear in a process diagram. Use action verbs when naming activity.</i>	<i>Describe the actions that take place in active and present tense. The step should be a descriptive noun/verb phrase that portrays an outline summary of the step. “If ...Then...Else” scenarios can be captured as multiple Actions or as separate steps.</i>	<i>What other actors are primarily responsible for Producing the information? Actors are defined in section1.5.</i>	<i>What other actors are primarily responsible for Receiving the information? Actors are defined in section1.5. (Note – May leave blank if same as Primary Actor)</i>	<i>Name of the information object. Information objects are defined in section 1.6</i>	<i>Elaborate architectural issues using attached spreadsheet. Use this column to elaborate details that aren’t captured in the spreadsheet.</i>	<i>Reference the applicable IECSA Environment containing this data exchange. Only one environment per step.</i>
1.1	T & D Feeder LineMeterDevice Query	DERSystem Controller	Check feeder overload projection	DER system receives ambient temperature, demand data and HVAC load data	Utility T & D data	DERSystemC ontroller	Ambient temperature and load data exceeding specified threshold values	?	DER Monitoring and Control
1.2		DERSystem Controller	DER system queries	DER system queries utility’s load prediction model	DERSystemC ontroller	LoadPredictio nModel	System data for use by the model		DER Monitoring and Control
1.3		DERSystem Controller	Identifies feeder line risk	Load prediction model identifies feeder line at risk of overload event	LoadPredictio nModel	DERSystemC ontroller	Information identifying feeder at risk		DER Monitoring and Control
1.4		DERSystem Controller	Activation trigger for DER program activities	DER system generates trigger to activate DER program for the identified feeder line	DERSystemC ontroller	DERDatabase	Activation trigger for DER program activities		DER Monitoring and Control
2	DER Activation	DERSystem Controller	Find Amount and types of power that can	DER system queries DER database to determine power	DERSystemC ontroller, T & D system,	DERSystemC ontroller	Amount and types of power that can be		DER Monitoring and Control

¹ Note – A triggering event is not necessary if the completion of the prior step – leads to the transition of the following step.

#	Event	Primary Actor	Name of Process/Activity	Description of Process/Activity	Information Producer	Information Receiver	Name of Info Exchanged	Additional Notes	IECSA Environments
	Order		be obtained from the customers participating in the DER program	capacity from customers in the affected segment	DERDatabase		obtained from the customers participating in the DER program		
2.1.1		DERSystem Controller	Actual available power from the targeted DER customers	DER system signals identified customers to determine availability	DERSystemC ontroller, CustomerCo mmunication Portal, DERSystemC ontroller	DERSystemC ontroller	Actual available power from the targeted customers		DER Monitoring and Control
2.1.2	DER systems signals to check for availability	DERSystem Controller	Activation alert to customers on pending program activation	DER system alerts customers with available power on system activation in 30 minutes	DERSystemC ontroller	CustomerCo mmunication Portal, DERSystemC ontroller	Activation alert to customers on pending program activation		DER Monitoring and Control
2.2		DERSystem Controller	Signal to turn on DER equipment at available customer sites	DER system turns on DER equipment at targeted customers' sites	DERSystemC ontroller	CustomerCo mmunication Portal, DERSystemC ontroller	Signal to turn on DER equipment at available customer sites		DER Monitoring and Control
2.3		DERSystem Controller	Activate PQ monitoring system	Activates PQ monitoring of delivered power	PQMonitorin gSystem	DERSystemC ontroller	PQ data on delivered power		DER Monitoring and Control
2.3.1	DER equipment failing	DERSystem Controller	Turn-off DER equipment	Turn off DER equipment failing PQ criteria	DERSystemC ontroller	DERSystemC ontroller, CustomerCo mmunication	Signal to failing units to turn off		DER Monitoring and Control

#	Event	Primary Actor	Name of Process/Activity	Description of Process/Activity	Information Producer	Information Receiver	Name of Info Exchanged	Additional Notes	IECSA Environments
						Portal			
2.3.1.1		DERSystem Controller	Flag PQ failing DER	Flag failing units for follow-up remedial actions	DERSystemC ontroller	DERDatabase	List of DERSystemCont roller units failing PQ criteria		DER Monitoring and Control
2.4		DERSystem Controller	Record energy delivered to the grid	Alert CustomerCommunicationPortal at conforming DER customers to record power delivery	DERSystemC ontroller	CustomerCommunication Portal, Customer NetMeterDevice-MeterDevice	Information on amount of power and duration of power delivered to the grid		DER Monitoring and Control
2.5		DERSystem Controller	Delay buying power on spot-market	Signal Purchasing Selling Entity to delay spot-market power purchase	DERSystemC ontroller	Purchasing Selling Entity	Delay buying decision for power purchase on spot-market		DER Monitoring and Control
2.6		DERSystem Controller	Determine contract power buy-back rate	2.6 Query utility's spot-market power database to determine contract power rate	Purchase Power Contracts Interactive Spot-Power Database -	DERSystemC ontroller, DERDatabase , CustomerBillingSystem	Power buy-back rate applicable to power from DERSystemCont roller to utility grid		DER Monitoring and Control
2.7		DERSystem Controller	On-going tracking feeder overload	On-going tracking feeder overload condition and load prediction model	LoadPredictionModel, T & D	DERSystemC ontroller	Status data indicating the need for DER power from customers		DER Monitoring and Control
3.1	Monitor T&D	DERSystem Controller	Predict if DER program and	LoadPredictionModel and T &D data indicate	LoadPredictionModel, T &	DERSystemC ontroller	Trigger to initiate DER		DER Monitoring

#	Event	Primary Actor	Name of Process/Activity	Description of Process/Activity	Information Producer	Information Receiver	Name of Info Exchanged	Additional Notes	IECSA Environments
	data		DRP can be terminated	DER activation can be terminated	D		event termination		and Control
3.2	DER program and DRP can be terminated	DERSystem Controller	DERSystemController initiates termination sequencing	DERSystemController initiates orderly sequencing DER program termination	DERSystemController, DERDatabase	CustomerCommunication Portal, DERSystemController	Message to DERSystemController unit on shutdown schedule		DER Monitoring and Control
3.2.1		DERSystem Controller	Transmit DER turn-off signal	Transmit DER turn-off signal to each customer as per the schedule	DERSystemController	CustomerCommunication Portal, DERSystemController	Signal to individual DER unit to terminate power delivery		DER Monitoring and Control
3.2.2	Transmit DER turn-off signal	DERSystem Controller	Confirmation of power delivery turn-off	Confirmation by customer unit of power delivery termination	CustomerCommunication Portal, DERSystemController	DERSystemController	Positive acknowledgment of system turn-off		DER Monitoring and Control
3.3		DERSystem Controller	Power delivered during DER event	Customer site transmits net power delivery during DER event	CustomerCommunication Portal, CustomerNetMeterDevice-MeterDevice	DERDatabase	Details of amount of power delivered, duration of power delivered during the DER event		DER Monitoring and Control
3.3.1		DERSystem Controller	Generate power delivery and rate information	Delivered power information and applicable rate data sent to billing system	DERSystemController, DERDatabase	CustomerBillingSystem	Amount and details of credit to be issued to customer for power delivered during the DER		DER Monitoring and Control

#	Event	Primary Actor	Name of Process/Activity	Description of Process/Activity	Information Producer	Information Receiver	Name of Info Exchanged	Additional Notes	IECSA Environments
							event		
3.3.2		DERSystem Controller	Amount of power purchase avoided due to DER program	Delivered power by customer DER units and peak load averted data to Purchasing Selling Entity	DERDatabase	Purchasing Selling Entity	Amount of power purchase avoided due to DER program activation		DER Monitoring and Control
3.3.3		DERSystem Controller	Signal no additional DER power to be purchased	Signal Purchasing Selling Entity that no additional power needs to be purchased	DERSystemController	Purchasing Selling Entity	Finalize decision not to purchase power in spot-power market		DER Monitoring and Control
3.4		DERSystem Controller	Retrieve list of failed DER units	Retrieve list of customer DER units that failed PQ criteria	DERDatabase	DERSystemController	List of customers requiring follow-up actions		DER Monitoring and Control
3.4.1	DER units failed PQ criteria	DERSystem Controller	Alert customer on PQ failure	Alert these customers on PQ failure details	DERDatabase	CustomerCommunication Portal	Details of PQ failure during DER event		DER Monitoring and Control
3.4.2	DER units failed PQ criteria fixed	CustomerCommunication Portal	Request PQ capability compliance confirmation	Request these customers to alert DERSystemController on bringing their system into compliance	DERDatabase	CustomerCommunication Portal	Alert affected customers on need for remedial actions		DER Monitoring and Control
3.4.3		DERSystem Controller	Flag affected customer sites	Flag the affected customer sites for future event till compliance confirmation is received	DERSystemController	DERDatabase	Flag the affected customers to indicate compliance confirmation is needed before they can be considered for		DER Monitoring and Control

#	Event	Primary Actor	Name of Process/Activity	Description of Process/Activity	Information Producer	Information Receiver	Name of Info Exchanged	Additional Notes	IECSA Environments
							program participation during future DER events		

2.1.3 Steps – Alternative / Exception Sequences

Describe any alternative or exception sequences that may be required that deviate from the normal course of activities. Note instructions are found in previous table.

#	Event	Primary Actor	Name of Process/Activity	Description of Process/Activity	Information Producer	Information Receiver	Name of Info Exchanged	Additional Notes	IECSA Environments

2.1.4 Post-conditions and Significant Results

Describe conditions that must exist at the conclusion of the Function. Identify significant items similar to that in the preconditions section.

Describe any significant results from the Function

<i>Actor/Activity</i>	<i>Post-conditions Description and Results</i>
Consumer	System status information [DER unit meets/fails PQ criteria], credit based on net-metered power delivery on next bill

<i>Actor/Activity</i>	<i>Post-conditions Description and Results</i>
T & D Grid	Satisfactory operation having avoided peak demand load event
DERDatabase	Updated with customer DER units that delivered power, DER units that failed, and details of power delivery (amount, duration and net-metered amount) during the DER event
Billing system database	Updated with credit to be issued to participating customers for power delivered as per applicable contract rates (90% of contracted spot-market power rates) during the DER event
Customer DER Equipment	Updated with pass/fail status after the DER event
Purchasing Selling Entity	Avoided purchase of power in spot-power market and details of the amount of power purchase avoided
LoadPredictionModel	Updated with actual system performance during the DER event for refining future projections

2.2 Architectural Issues in Interactions

Elaborate on all architectural issues in each of the steps outlined in each of the sequences above. Reference the Step by number..

2.3 Diagram

For clarification, draw (by hand, by Power Point, by UML diagram) the interactions, identifying the Steps where possible.

3 Auxiliary Issues

3.1 References and contacts

Documents and individuals or organizations used as background to the function described; other functions referenced by this function, or acting as “sub” functions; or other documentation that clarifies the requirements or activities described. All prior work (intellectual property of the company or individual) or proprietary (non-publicly available) work must be so noted.

ID	Title or contact	Reference or contact information
[1]	P. S. Vishwanath	Paragon Consulting Services, 301-323-4088
[2]	Joe Kelly	Paragon Consulting Services, 503-978-8289

3.2 Action Item List

As the function is developed, identify issues that still need clarification, resolution, or other notice taken of them. This can act as an Action Item list.

ID	Description	Status
[1]		
[2]		

3.3 Revision History

For reference and tracking purposes, indicate who worked on describing this function, and what aspect they undertook.

No	Date	Author	Description
0.1	December 17, 2003		First draft
0.2	December 19, 2003	P S V	Revisions and updates to missing sections

This page intentionally left blank.

Consumer Portal Scenario P9

1 Descriptions of Function

All prior work (intellectual property of the company or individual) or proprietary (non-publicly available) work should be so noted.

1.1 Function Name

Name of Function: Utility promotion of electric vehicles (EV) through reduced electricity rates for nighttime recharging of vehicle battery.

1.2 Function ID

IECSA identification number of the function

C-10, C10-1

1.3 Brief Description

Describe briefly the scope, objectives, and rationale of the Function

A utility company wants to promote the increased use of electric vehicles in its service area by offering significantly reduced electricity rates for nighttime recharging of vehicle battery. Each EV is given a unique id which is keyed to the customer so that the utility's billing system can bill the customer under the reduced EV charging rates. The system also permits the customer to use the charging station at another customer's site [such as at a friend's house] and have the system bill the vehicle owner instead of the customer whose charging station is used.

1.4 Narrative

A complete narrative of the Function from a Domain Expert's point of view, describing what occurs when, why, how, and under what conditions. This will be a separate document, but will act as the basis for identifying the Steps in Section 2.

A western utility has a residential customer base of 1 million meters. The meters are installed in single-family detached housing (SFD), single-family attached housing (SFA), apartment buildings and mobile homes. The utility wishes to promote the use of alternate fueled cars including electric vehicles and fuel-cell powered vehicles.

The utility decides to incentivize the residential use of electric vehicles by offering greatly reduced kWh tariffs for nighttime recharging. The issues confronting the utility are:

- They need to know which homes have electric vehicles by meter number and premise number.

The utility goes through the following procedures.

1. The utility offers discounted electricity to recharge electric vehicle batteries. To do this a customer must purchase the car and charging station using their own resources and as an incentive the utility offers greatly reduced nighttime charging rates/kWh. The customer plugs in the car to the charger and requests “charge at cheapest rates”. The utility is notified of the cars presence, its ID number (which must correspond to the car registered with the homeowner), and its approximate charge requirement (provided by the car’s on board computer). The utility schedules the recharge to take place during the evening hours and at different times than other EV charging (thus putting diversity into the load).
2. The billing department now calculates the amount of money to charge the EV customer based on EV rates and for the measured time period.
3. The same EV customer drives to a friend’s home (who also has an EV) and requests a quick charge to make sure that he can get back home. When he plugs his EV into his friend’s EV charger, the utility identifies the fact that the EV belongs to a different customer and places the charging bill on the correct persons invoice, not on the friend’s bill who offered his charging station.
4. The billing department now calculates the amount of money to invoice the customer who owns the EV, based on EV rates and for the measured time period.

1.5 Actor (Stakeholder) Roles

Describe all the people (their job), systems, databases, organizations, and devices involved in or affected by the Function (e.g. operators, system administrators, technicians, end users, service personnel, executives, SCADA system, real-time database, RTO, RTU, Intelligent Electronic Device, power system). Typically, these actors are logically grouped by organization or functional boundaries or just for collaboration purpose of this use case. We need to identify these groupings and their relevant roles and understand the constituency. The same actor could play different roles in different Functions, but only one role in one Function. If the same actor (e.g. the same person) does play multiple roles in one Function, list these different actor-roles as separate rows.

<i>Grouping (Community)'</i>		<i>Group Description</i>
<i>Customer Site</i>		<i>Those entities that are located at customer's premises</i>
<i>Actor Name</i>	<i>Actor Type (person, device, system etc.)</i>	<i>Actor Description</i>
Customer	Person	One signed up to participate in the Distributed Energy Resource (DER) program.
CustomerCommunicationPortal	System	Customer Communications Portal (CustomerCommunicationPortal), System handling communications function at customer's premises [in this case, identifying the customer, communications with the charging station, the EV's on-board computer, meter, and the utility]
Meter Device	Device	Device that can measure the power consumed by the customer along with the time at which the power is consumed (so that in this case the utility can charge the appropriate rate for the EV charging at time) and transmit the information to the utility for billing purposes
EV Charging Station	System	System at the customer site used to charge the EV batteries
EV Id Number	Device	Unique identification number assigned to each participating EV by the utility for tracking power used to charge the batteries of that vehicle
EV On-Board System	System	System in the EV used to communicate with the utility via the EV Charging Station and the CustomerCommunicationPortal at the customer location

Replicate this table for each logic group.

<i>Grouping (Community)</i>		<i>Group Description</i>
<i>Power Company Electric Vehicle Operations</i>		<i>Those entities that are charged with managing the EV-related functions for the power company</i>
<i>Actor Name</i>	<i>Actor Type (person, device, system etc.)</i>	<i>Actor Description</i>
EVOperationSystem	System	System that contains information about the rates applicable to Electric Vehicle (EV) charging, customers participating in the EV program, their location, and details of their system, such as EV Id, amount of power needed to charge the system, and so on.
EVChargingScheduler	System	System that manages the scheduling of charging of EV to ensure system load diversity
CustomerId	Device	Customer identification key that is used by the power company to identify customer for associating the customer with its billing activities
CustomerBillingSystem	System	System that handles generation of bills for the services provided to the customer
Utility Communications Network	System	System responsible for managing communications between the utility and the participants in the EV program [for functions such as remote meter reading, controlling EV charging stations at customer sites, monitoring EV charging activities and other related communications activities]
EV		

<i>Grouping (Community)</i>		<i>Group Description</i>
<i>Others</i>		<i>Those entities that are involved in this activity, but do not fit in any of the Groupings above</i>
<i>Actor Name</i>	<i>Actor Type (person, device, system etc.)</i>	<i>Actor Description</i>
Third Party EV Charging Station	System	System at a different customer's site [other than the owner of the EV being charged] for charging EV batteries
EnergyServiceProvider		

1.6 Information exchanged

Describe any information exchanged in this template.

<i>Information Object Name</i>	<i>Information Object Description</i>
EV Charge Request from Customer's Home Location	Request from customer to charge EV at "cheapest available rates" from the home location along with EV Id, CustomerId and related EV information
EV Charge Implementation at Customer's Home Location	System order to verify customer information, schedule EV charging after checking other EV charging already scheduled in that area, initiating the charging operation, alerting the CustomerCommunicationPortal and meter to acquire the power used for charging and time when used, collecting the metering information at the conclusion of the charging activity, and flagging the power delivered for appropriate billing rates by the billing system
EV Charge Request from Third Party Location	Request from customer to charge EV from a third party location along with EV Id, CustomerId, third party location EV Charging Station and customer id information and related EV information

<i>Information Object Name</i>	<i>Information Object Description</i>
EV Charge Implementation at Third Party Location	System order to verify customer and third party location information, schedule a quick-charge EV charging operation, alerting the CustomerCommunicationPortal and meter to acquire the power used for charging and time when used, collecting the metering information at the conclusion of the charging activity, and flagging the power delivered for appropriate billing rates by the billing system to the customer account associated with the EV (and not the third party location customer whose EV Charging Station was used for the quick charge operation)

1.7 Activities/Services

Describe or list the activities and services involved in this Function (in the context of this Function). An activity or service can be provided by a computer system, a set of applications, or manual procedures. These activities/services should be described at an appropriate level, with the understanding that sub-activities and services should be described if they are important for operational issues, automation needs, and implementation reasons. Other sub-activities/services could be left for later analysis.

<i>Activity/Service Name</i>	<i>Activities/Services Provided</i>
Receive Customer Initiated EV Charge Request	On receipt of customer initiated EV charge request, verify charge request origin by accessing EVOperationSystem database to compare EV Id with CustomerId sent by the CustomerCommunicationPortal: if the request origin is same as customer home location, then set flag to implement EV charging at customer location; if request origin is not customer home location, then set flag to implement EV charging at third party location.
Implement EV Charging	Initiate EV charging actions: access EVOperationSystem Database to determine charging requirements, access EVChargingScheduler to assign time slot for charging to ensure load diversity, initiate charging at the assigned time, alert CustomerCommunicationPortal and meter to record power consumption and to transmit power usage data on completion of the charging operation, and signal CustomerCommunicationPortal to turn off the charging station. If the request originated from a third party location, then implement a quick charge operation as soon as possible [so as to enable the customer EV to be charged for travel back to customer home location].
Complete Post-Charge Activities	Initiate actions to transmit metering data to customer billing system to generate a charge based on applicable EV tariff rates. If the operation is customer home location charging, then the customer's

<i>Activity/Service Name</i>	<i>Activities/Services Provided</i>
	account is billed; if the operation is third party charging, then the customer account associated with the EV is billed for the charging operation.

1.8 Contracts/Regulations

Identify any overall (human-initiated) contracts, regulations, policies, financial considerations, engineering constraints, pollution constraints, and other environmental quality issues that affect the design and requirements of the Function.

<i>Contract/Regulation</i>	<i>Impact of Contract/Regulation on Function</i>
EV Program Tariffs	Reduced electric power rates based on off-peak charging based on customer acquiring required equipment at their cost – such as the EV, the charging station and related equipment

<i>Policy</i>	<i>From Actor</i>	<i>May</i>	<i>Shall Not</i>	<i>Shall</i>	<i>Description (verb)</i>	<i>To Actor</i>
Install EV Equipment	Customer			X	Customer needs to buy their EV and install EV Charging system at site to participate in the program	EnergyServiceProvider
Provide EV Id	EnergyServiceProvider			X	Provide customer's EV with a unique id that will be transmitted when the EV is plugged into a charging station	Customer
Provide EV Rates	EnergyServiceProvider			X	Provide reduced electric power rates that will be applied to charging EV at off-peak times	Customer

<i>Constraint</i>	<i>Type</i>	<i>Description</i>	<i>Applies to</i>
<i>Charging Period</i>	<i>Rate Availability</i>	<i>A customer can utilize special EV power rates for charging during specified off-peak periods</i>	<i>Request for EV charging by customer</i>

2 Step by Step Analysis of Function

Describe steps that implement the function. If there is more than one set of steps that are relevant, make a copy of the following section grouping (Preconditions and Assumptions, Steps normal sequence, and Steps alternate or exceptional sequence, Post conditions)

2.1 Steps to implement function

Name of this sequence.

2.1.1 Preconditions and Assumptions

Describe conditions that must exist prior to the initiation of the Function, such as prior state of the actors and activities

Identify any assumptions, such as what systems already exist, what contractual relations exist, and what configurations of systems are probably in place

Identify any initial states of information exchanged in the steps in the next section. For example, if a purchase order is exchanged in an activity, its precondition to the activity might be 'filled in but unapproved'.

<i>Actor/System/Information/Contract</i>	<i>Preconditions or Assumptions</i>
EV Equipment	Assumes that the customer has specified EV equipment, such as EV, Charging Station and related equipment, at customer location
EV Program tariff	Assumes that a tariff exists with details of program requirements and reduced charging power rates that the customer can sign up
EVOperationSystem	Assumes that the utility has a database with customer EV information keyed to customer id and location information
CustomerCommunicationPortal	Assumes that the CustomerCommunicationPortal is installed in the customer location that will permit communications with the customer and EV equipment

<i>Actor/System/Information/Contract</i>	<i>Preconditions or Assumptions</i>
EV Id	Assumes each EV has been assigned a unique Id and that this information is transmitted by EV and/or accessible by the utility

2.1.2 Steps – Normal Sequence

Describe the normal sequence of events, focusing on steps that identify new types of information or new information exchanges or new interface issues to address. Should the sequence require detailed steps that are also used by other functions, consider creating a new “sub” function, then referring to that “subroutine” in this function. Remember that the focus should be less on the algorithms of the applications and more on the interactions and information flows between “entities”, e.g. people, systems, applications, data bases, etc. There should be a direct link between the narrative and these steps.

The numbering of the sequence steps conveys the order and concurrency and iteration of the steps occur. Using a Dewey Decimal scheme, each level of nested procedure call is separated by a dot ‘.’. Within a level, the sequence number comprises an optional letter and an integer number. The letter specifies a concurrent sequence within the next higher level; all letter sequences are concurrent with other letter sequences. The number specifies the sequencing of messages in a given letter sequence. The absence of a letter is treated as a default 'main sequence' in parallel with the lettered sequences.

Sequence 1:

*1.1 - Do step 1
1.2A.1 - In parallel to activity 2 B do step 1
1.2A.2 - In parallel to activity 2 B do step 2
1.2B.1 - In parallel to activity 2 A do step 1
1.2B.2 - In parallel to activity 2 A do step 2
1.3 - Do step 3
1.3.1 - nested step 3.1
1.3.2 - nested step 3.2*

Sequence 2:

*2.1 - Do step 1
2.2 - Do step 2*

#	Event	Primary Actor	Name of Process/Activity	Description of Process/Activity	Information Producer	Information Receiver	Name of Info Exchanged	Additional Notes	IECSA Environments
#	<i>Triggering event? Identify the name of the event.¹</i>	<i>What other actors are primarily responsible for the Process/Activity? Actors are defined in section1.5.</i>	<i>Label that would appear in a process diagram. Use action verbs when naming activity.</i>	<i>Describe the actions that take place in active and present tense. The step should be a descriptive noun/verb phrase that portrays an outline summary of the step. “If ...Then...Else” scenarios can be captured as multiple Actions or as separate steps.</i>	<i>What other actors are primarily responsible for Producing the information? Actors are defined in section1.5.</i>	<i>What other actors are primarily responsible for Receiving the information? Actors are defined in section1.5. (Note – May leave blank if same as Primary Actor)</i>	<i>Name of the information object. Information objects are defined in section 1.6</i>	<i>Elaborate architectural issues using attached spreadsheet. Use this column to elaborate details that aren’t captured in the spreadsheet.</i>	<i>Reference the applicable IECSA Environment containing this data exchange. Only one environment per step.</i>
1	Customer Request for EV Charging	Customer	Request for EV charging	Customer plugs in EV into charging station	EV On-Board System	EV Charging Station and CustomerCommunication Portal	Charging Request	?	Intra-Customer Site
1.1.1		EV On-Board System	EV On-Board System Identifies the EV	EV On-Board System sends EV Id Number and charging requirements	EV On-Board System	CustomerCommunication Portal	EV Id, EV charge requirements		Intra-Customer Site
1.1.2		CustomerCommunication Portal	CustomerCommunication Portal location and EV information	CustomerCommunication Portal at location sends EV information, CustomerId and CustomerCommunication Portal location information	CustomerCommunication Portal	EV Operation System	Customer information and EV/CustomerCommunication Portal location information		Intra-Customer Site
1.2		EV Operation System	Determine type of charging to implement	Power Company compares EV and location information to	EV Operation System	EV Operation System	Identify if the vehicle is at customer or		Intra-Customer Site

¹ Note – A triggering event is not necessary if the completion of the prior step – leads to the transition of the following step.

#	Event	Primary Actor	Name of Process/Activity	Description of Process/Activity	Information Producer	Information Receiver	Name of Info Exchanged	Additional Notes	IECSA Environments
				determine type of charging to implement			third-party location		
2.1	Charging request from customer home	EVOperationSystem	Determine electric rate applicable	EVOperationSystem queries EVOperationSystem to determine electric rate applicable to request	CustomerId, EV Id Number	EVOperationSystem	EV power rates		Intra-Customer Site
2.1.1		EVOperationSystem	Confirms charging requirements	EVOperationSystem confirms charging requirements	EVOperationSystem	EVOperationSystem	EV charging requirements		Intra-Customer Site
2.2		EVChargingScheduler	Assign charging time slot	EVOperationSystem queries EVChargingScheduler to assign charging time slot	EVChargingScheduler	EVOperationSystem			Intra-Customer Site
2.2.1		EVChargingScheduler	Informs CustomerCommunicationPortal on charging start time	EVChargingScheduler informs CustomerCommunicationPortal on charging start time	EVChargingScheduler	CustomerCommunicationPortal	Time slot allotment for EV charging		Intra-Customer Site
2.3		CustomerCommunicationPortal	Turns on Charging Station	CustomerCommunicationPortal turns on Charging Station at assigned time	CustomerCommunicationPortal	EV Charging Station, EV	Initiate EV charging		Intra-Customer Site
2.3.1		CustomerCommunicationPortal	CustomerCommunicationPortal alters meter	CustomerCommunicationPortal alerts meter to start monitoring power used for charging	CustomerCommunicationPortal	Meter Device	Start measuring power consumption		Intra-Customer Site

#	Event	Primary Actor	Name of Process/Activity	Description of Process/Activity	Information Producer	Information Receiver	Name of Info Exchanged	Additional Notes	IECSA Environments
2.3.2		EV On-Board System	Turn off charging	EV On-Board System turns off Charging station on completing the charging operation	EV On-Board System	EV Charging Station	Turn off power to EV		Intra-Customer Site
2.3.3		Meter Device	Power Consumption information	Meter Device sends power consumption information to CustomerCommunicationPortal	Meter Device	CustomerCommunicationPortal	Power consumed for EV charging		Intra-Customer Site
2.3.4		EVOperationSystem	Completion of charging	CustomerCommunicationPortal confirms to EVOperationSystem on completion of charging operation	CustomerCommunicationPortal	EVOperationSystem	Completion of charging operation		Intra-Customer Site
3.1	Charging Request from third party location	EVOperationSystem	Mark as third party charging event	EVOperationSystem alerts EVOperationSystem to mark charging operation as third party charging event		EVOperationSystem	Flag identifying operation as third-party charging event		Intra-Customer Site
3.1.1		EVOperationSystem	Collect EV and Customer information	EVOperationSystem collects EV customer Id and CustomerCommunicationPortal customer Id [owner of the third-party charging station] information	CustomerId of EV owner, EV Id Number, CustomerId of CustomerCommunicationPortal	EVOperationSystem	EV and Customer information		Intra-Customer Site

#	Event	Primary Actor	Name of Process/Activity	Description of Process/Activity	Information Producer	Information Receiver	Name of Info Exchanged	Additional Notes	IECSA Environments
3.1.2		EVOperationSystem	Determine electric rate applicable	EVOperationSystem queries EVOperationSystem to determine electric rate applicable to request	CustomerId, EV Id Number	EVOperationSystem	EV power rates		Intra-Customer Site
3.1.3		EVOperationSystem	Confirm charging requirements	EVOperationSystem confirms charging requirements	EVOperationSystem	EVOperationSystem	EV charging requirements		Intra-Customer Site
3.2		EVOperationSystem	Assign charging time slot	EVOperationSystem queries EVChargingScheduler to assign charging time slot	EVChargingScheduler	EVOperationSystem			Intra-Customer Site
3.2.1		EVChargingScheduler	Informs CustomerCommunicationPortal on charging start time	EVOperationSystem informs CustomerCommunicationPortal on charging start time	EVChargingScheduler	CustomerCommunicationPortal	Time slot allotment for EV charging		Intra-Customer Site
3.3		CustomerCommunicationPortal	Turns on Charging	CustomerCommunicationPortal turns on Charging Station at assigned time	CustomerCommunicationPortal	EV Charging Station, EV	Initiate EV charging		Intra-Customer Site
3.3.1		CustomerCommunicationPortal	CustomerCommunicationPortal alters meter	CustomerCommunicationPortal alerts meter to start monitoring power used for charging	CustomerCommunicationPortal	Meter Device	Start measuring power consumption		Intra-Customer Site
3.3.2		EV On-Board System	Turn off charging	EV On-Board System turns off Charging Station on completing	EV On-Board System	EV Charging Station	Turn off power to EV		Intra-Customer Site

#	Event	Primary Actor	Name of Process/Activity	Description of Process/Activity	Information Producer	Information Receiver	Name of Info Exchanged	Additional Notes	IECSA Environments
				the charging operation					
3.3.3		Meter Device	Power Consumption information	Meter Device sends power consumption information to CustomerCommunicationPortal	Meter Device	CustomerCommunicationPortal	Power consumed for EV charging		Intra-Customer Site
3.3.4		EVOperationSystem	Completion of charging	CustomerCommunicationPortal confirms to EVOperationSystem on completion of charging operation	CustomerCommunicationPortal	EVOperationSystem	Completion of charging operation		Intra-Customer Site
3.3.5		EVOperationSystem	Power Consumption data sent to Database	Power consumption data flagged to EV owner's CustomerId	CustomerCommunicationPortal	EVOperationSystem	Assign power usage to EV owner's account		Intra-Customer Site
4.1		EVOperationSystem	Transmit power consumption to Billing	Transmit power consumption information to CustomerBillingSystem	EVOperationSystem	CustomerBillingSystem	Power consumer and applicable rate for EV charging		Intra-Customer Site
4.1.1		CustomerBillingSystem	Billing information for the power consume	Alert EV owner's CustomerCommunicationPortal with charge information	CustomerBillingSystem	CustomerCommunicationPortal	Billing information for the power consumed for charging		Intra-Customer Site
4.1.2		EVOperationSystem	Acknowledgment of charging	Confirm charging operation completion to EVChargingScheduler	EVOperationSystem	EVChargingScheduler	Acknowledgment of charging operation completion		Intra-Customer Site

2.1.3 Steps – Alternative / Exception Sequences

Describe any alternative or exception sequences that may be required that deviate from the normal course of activities. Note instructions are found in previous table.

#	Event	Primary Actor	Name of Process/Activity	Description of Process/Activity	Information Producer	Information Receiver	Name of Info Exchanged	Additional Notes	IECSA Environments

2.1.4 Post-conditions and Significant Results

Describe conditions that must exist at the conclusion of the Function. Identify significant items similar to that in the preconditions section.

Describe any significant results from the Function

<i>Actor/Activity</i>	<i>Post-conditions Description and Results</i>
Customer	Confirmation of EV charging and billing information
EV	EV batteries fully charged
EV owner's CustomerCommunicationPortal	Updated with details of power delivery (amount, duration and billed amount) for EV charging event
Customer Billing system	Updated with EV owner's account charged with power consumed for the EV charging event
Third-Party CustomerCommunicationPortal	Updated with confirmation of power used for EV charging to EV owner's account

<i>Actor/Activity</i>	<i>Post-conditions Description and Results</i>
EVOperationSystem	Updated with information on EV Id, CustomerId, power consumed and account charged [EV owner]
EVChargingScheduler	Updated with actual system performance during the EV charging event for refining future scheduling

2.2 Architectural Issues in Interactions

Elaborate on all architectural issues in each of the steps outlined in each of the sequences above. Reference the Step by number..

2.3 Diagram

For clarification, draw (by hand, by Power Point, by UML diagram) the interactions, identifying the Steps where possible.

3 Auxiliary Issues

3.1 References and contacts

Documents and individuals or organizations used as background to the function described; other functions referenced by this function, or acting as “sub” functions; or other documentation that clarifies the requirements or activities described. All prior work (intellectual property of the company or individual) or proprietary (non-publicly available) work must be so noted.

ID	Title or contact	Reference or contact information
[1]	P. S. Vishwanath	Paragon Consulting Services, 301-323-4088
[2]	Joe Kelly	Paragon Consulting Services, 503-978-8289

3.2 Action Item List

As the function is developed, identify issues that still need clarification, resolution, or other notice taken of them. This can act as an Action Item list.

ID	Description	Status
[1]		
[2]		

3.3 Revision History

For reference and tracking purposes, indicate who worked on describing this function, and what aspect they undertook.

No	Date	Author	Description
0.1	December 22, 2003		First draft
0.2	December 29, 2003	P S V	Revisions and updates to missing sections

This page intentionally left blank.

Functional Requirements for Network Management

Use Case Description¹

1. Descriptions of Function

All prior work (intellectual property of the company or individual) or proprietary (non-publicly available) work should be so noted.

1.1 **Function Name**

Name of Function

Enterprise Management (EM) Function.

1.2 **Function ID**

IECSA identification number of the function

1.3 **Brief Description**

Describe briefly the scope, objectives, and rationale of the Function.

Objective: Enterprise management is the task of ensuring that the networks and systems provide the required services with the specified quality of service to the users and other systems. Most enterprise management architectures use agent-manager relationship where the agents, residing on managed network/system elements, provide network/system management information such as alerts or performance measurements to the manager. The manager reacts to these messages by executing one or more actions such as operator notification, event logging, system shutdown, and automatic attempts at system repair. Management entities also poll end stations, automatically or upon user request, to check the values of certain variables. Agents have information about the managed devices in which they reside and provide that information (proactively or reactively) to management entities within one or more enterprise management systems (EMSs) via a network management protocol. The term enterprise management refers to the combined task of network and system management.

Scope: The functions of an enterprise manager facilitated by an EnergyManagementSystem includes:

- Performance Management which involves measurements of various metrics for network/system performance, analyzing the measurements to determine normal levels, and determination of appropriate threshold values to ensure required level of performance for each service. Examples of performance metrics include network/system throughput, user response times, and line utilization. Management entities continually monitor values of the performance metrics. An alert is generated and sent to the enterprise management system when a threshold is exceeded

¹ Background information includes prior UCI work

- Configuration Management which involves maintaining an inventory of the network and system configuration information. This information is used to assure inter-operability and problem detection. Examples of configuration information include device/system OS name and version, types and capacity of interfaces, types and version of the protocol stacks, type and version of network/system management SW, etc.
- Accounting Management which keeps track of usage per account, billing, and ensures resources are available according to the account requirements.
- Fault Management detects, fixes, logs, and reports network/system problems. Fault management involves determining symptoms through measurements and monitoring, and isolating the problem.
- Security Management which controls access to network/system resources according to security guidelines. Security manager partitions network/system resources into authorized and unauthorized areas. Users are provided access rights to one or more areas. Security managers identify sensitive network/system resources (including systems, files, and other entities) and determine accessibility of users and the resources. Security manager monitors access points to sensitive network/system resources and log inappropriate access.

Typically, network management refers to management of network/system resources such as routers, switches, hubs, customer premises equipment and communication links. We extend the domain of enterprise management to enterprise management, defined as the set of functions needed to manage the following resources:

1. Network resources, as defined above,
2. Systems – Computing resources such as substation automation systems, data concentrators, servers such as Market Interface Servers, applications such as data acquisition and control systems, and database management systems,
3. Service and business functions such as RTP customer pricing service, security and operational policy servers,
4. Power system devices such as IEDs and RTUs,
5. Customer premises equipment such as digital meters and consumer portals, and
6. Storage area networks.

Rationale: Proper execution of enterprise management functions not only supports the power system functional requirements such as ensuring connectivity and enforcement of policies, but also the non-functional requirements such as providing quality of service, ensuring reliable and securing communications.

Status: Enterprise management functions are being carried out within the power system industry. The emphasis of the IECSA is in proper and complete execution of all the relevant functions in addition to proposing a unified management platform to simplify cross-management functions.

1.4 Narrative

A complete narrative of the Function from a Domain Expert's point of view, describing what occurs when, why, how, and under what conditions. This will be a separate document, but will act as the basis for identifying the Steps in Section 2.

1.5 Actor (Stakeholder) Roles

Describe all the people (their job), systems, databases, organizations, and devices involved in or affected by the Function (e.g. operators, system administrators, technicians, end users, service personnel, executives, SCADA system, real-time database, RTO, RTU, IED, power system). Typically, these actors are logically grouped by organization or functional boundaries or just for collaboration purpose of this use case. We need to identify these groupings and their relevant roles and understand the constituency. The same actor could play different roles in different Functions, but only one role in one Function. If the same actor (e.g. the same person) does play multiple roles in one Function, list these different actor-roles as separate rows.

Grouping (Community)		Group Description
Enterprise Management		
Actor Name	Actor Type (person, device, system etc.)	Actor Description
EnterpriseManager	Person	Person performing the function of enterprise management
EnergyManagementSystem	System	Enterprise Management System – EnergyManagementSystem manager, EnergyManagementSystem agent
Customer	Person	The person/company/user of the network/system services
ServiceProvider	Person	The person/company providing network/system services.
ManagedDevice	device	The entity being managed
ManagedDevice2	device	The entity being managed

Replicate this table for each logic group.

1.6 Information exchanged

Describe any information exchanged in this template.

Information Object Name	Information Object Description
PerformanceData	Types of performance metrics collected by the NMS
ConfigurationData	Configuration Data sent from Manager to Agent
FaultData	Fault data received sent from Agent to Manager
GetRequest	A request to receive data sent from Manager to the Agent.

1.7 Activities/Services

Describe or list the activities and services involved in this Function (in the context of this Function). An activity or service can be provided by a computer system, a set of applications, or manual procedures. These activities/services should be described at an appropriate level, with the understanding that sub-activities and services should be described if they are important for operational issues, automation needs, and implementation reasons. Other sub-activities/services could be left for later analysis.

Activity/Service Name	Activities/Services Provided
Object management - Defining resources and attributes	EnergyManagementSystem needs to be aware of resources: routers, hubs, computers, and their attributes.
Defining, modifying and examining relationships	EnergyManagementSystem needs to be aware of the object relationships.
Setting, modifying and examining attribute values	Object attributes need to have values. E.g, number & types of ports per card.
Inventory Management	IM is the task of maintaining types and configuration of resources. The inventory information is required for SW and HW maintenance, determination of faults and recovery, and capacity planning.
Network Discovery	Dynamically creates a representation of the network topology, and configuration of the devices. The data could be collected manually, which is very tedious and often not accurate for a large network, or through an EnergyManagementSystem. Instances of the managed devices and their internal components are created and connections are made. Components and info on the devices include network cards, ports, interfaces, power supplies, MAC addresses, SW version, OS type, CPU types, IP addresses, etc.
Address Management	Address management includes allocation IP addresses to devices, determination of subnets, keeping track of used and available IP addresses, and reuse of unused addresses. This task reduces addressing complexities and waste of address space.
Name Management	Naming establishes a connection between a name and a device, its location, its type, etc. Helps identify devices, IP address mappings, etc. Naming conventions for network devices, starting from device name to individual interface, should be planned and implemented as part of the configuration standard. A well defined naming convention provides the ability to obtain accurate information when troubleshooting. The naming convention for devices can use geographical location, building name, floor, and so forth. For the interface naming convention, it can include the segment to which a port is connected, name of connecting hub, and so forth.
Routing management	Determine and configure routing tables. This includes configuring parameters for IP routing , Quality of Service, etc.
SW distribution and upgrade	This includes detection of SW releases, distribution of new releases, and testing for interoperability.
Setting & verifying user authorization	

<i>Activity/Service Name</i>	<i>Activities/Services Provided</i>
Scheduling, user/flow/packet prioritization	This is to allow for a specific treatment of users, flows, or packets based on availability of features on the routers, switches and computers to meet QoS requirements or SLA's.
Resource dimensioning and allocation	Engineering the network elements for more efficient utilization and assurance to meet QoS. For example, sizing buffers.
Configuring for redundancies to assure reliability requirements	This is to design the network/systems to provide some tolerance to faults. For example, providing alternative routing, redundant computing, etc.
Initializing and terminating network operations, device reset.	This task is to initialize or shutdown the network and systems.
Setting values for fault threshold, health check intervals, performance thresholds	This task requires an enterprise manager to set and configure threshold values for the purpose of alarm monitoring and performance monitoring.
Polling for faults, health check, running watch-dog timers, processing traps	This task defines the function of either receiving or polling for alarms.
Log control	
Diagnostic testing, testing capacity and special conditions	Testing to either proactively detect a failure of some device/application/element or trying to locate faults.
fault location	Determination of fault location through testing, alarm correlation, analysis, etc.
Fault data summarization	
Reconfigure, reroute, remove Reroute	Activities to recover from fault conditions
Issue trouble ticket	Activity to document fault
Dispatch technician	
Determining the set of key performance indicators	The task of determining what performance metrics to measure. Examples are delay, response time, packet loss, buffer overflow, etc.
Mapping SLA/user perf. objectives into network/system performance objectives	Mapping higher level service agreements such as response time, to network and system performance objectives such as processing times on each CPU, transport time, priority setting, etc.
Continuous real-time performance monitoring, performance alarm generation	Alarms, statistics, history, and host/conversation groups are used to monitor and maintain network/system availability based on application-layer traffic. Performance metrics at the interface, device, and protocol levels are collected regularly to facilitate enterprise management, capacity planning, rerouting functions. The EMSs typically collect, store, and present performance data from network devices and servers. Examples of performance metrics collected are: response time, jitter (delay variance), packet loss, input/output queuing time, input/output buffer overflow, transaction time, occupancy (utilization) of

<i>Activity/Service Name</i>	<i>Activities/Services Provided</i>
	resources.
Performance and statistical analysis of measured values, Performance data summarization	Post analysis of measured performance indicators for capacity planning, traffic engineering, reconfigurations, etc.
Traffic management	Determine the traffic characteristics from each source, and their resource requirements. configure the network elements, systems, to meet the requirements. User and application traffic profiling provides a detailed view of the traffic in the network. Some EMSs allow the enterprise managers to analyze and troubleshoot networked applications such as Web traffic, NetWare, Notes, e-mail, database access, Network File System (NFS),etc.
Capacity planning	Determine the traffic growth and plan for growth. Capacity planning for the network/system can be done following gathering of traffic statistics such as traffic amount and source and destination IP addresses, Input and output interface numbers, TCP/UDP source port and destination ports, source and destination of administrative groups, etc.
Establishing, maintaining and monitoring Service Level Agreements (SLA)	A service level agreement (SLA) is established between a service provider and its customer on the expected performance level of network/system services. Examples of the performance metrics used in SLA's are : guaranteed throughput, percentage of time with service availability, packet latency, percentage of packet delivery, outage reporting time, response time to denial of service attacks, service activation time, etc. Set parameters (routing, addressing, etc) in devices to meet policy requirements. Monitor operations according to the policy. Identify policy violations
Authentication and Authorization	Identify users before being allowed to access network/system resources. Authorization provides various level of authority to the user.
Accounting of Security Info	Collect and report security information used for billing, auditing, such as user identities, start and stop times, and executed commands. Accounting enables enterprise managers to track the services that users are accessing as well as the amount of network/system resources they are consuming.
Establish Access Control List	To control access of unauthorized users to network/system resources..
Policy Management, policy specification, translation and distribution.	This activity involves collection and inclusion of the various network/system related policies into the enterprise management activities. The policies include QoS, Security, Address allocation, and routing policies. A policy management tool can assist the enterprise managers in obtaining high level policies and translating them into low level policies that are to be enforced by the network devices, or <i>policy enforcement points</i> . A <i>policy repository</i> , a database of the high and low level policies, is used by these tools.
Accounting Management	Accounting management is the process used to measure network/system utilization parameters so that individual or group users on the network/system for accounting or billing. A usage-based accounting and billing system is an essential part of any service level agreement (SLA). It provides both a practical way of defining obligations under an SLA and clear consequences for behavior outside the terms of the SLA. The

<i>Activity/Service Name</i>	<i>Activities/Services Provided</i>
	data can be collected via NMSs. The probes to measure the statistics are places on the edge or access routers at the point of entry to the network/system. Measuring traffic flow (number of bytes, number of packets) for a specific source-destination pair (based on IP addresses). This information can also be used to check for security violations.
Specifying accounting information to be collected	
Setting and modifying accounting limits	
Defining accounting metrics	
Implementing/activating metering functions	
Controlling the storage of and access to accounting information	
Monitoring usage	
Regulating users and groups	
Billing	
Reporting	Report accounting information, configuration status, fault data, performance data , policy changes and violations

1.8 Contracts/Regulations

Identify any overall (human-initiated) contracts, regulations, policies, financial considerations, engineering constraints, pollution constraints, and other environmental quality issues that affect the design and requirements of the Function.

<i>Contract/Regulation</i>	<i>Impact of Contract/Regulation on Function</i>
SLA's between provider and user/organizations on security.	NM activities need to ensure that these SLA are met through proper network/system configuration, routing configuration, setting and enforcing security levels if possible, determining security mechanisms, etc. Examples of SLAs are ability to access an application by only a specified set of users, ability to read or write DB, the agreement that all the communications is to be encrypted, etc.
Contracts between service providers for routing configurations.	NM activities need to ensure that the administrative boundaries are set, routing agreements are met, and routing policies are enforced.

<i>Policy</i>	<i>From Actor</i>	<i>May</i>	<i>Shall Not</i>	<i>Shall</i>	<i>Description (verb)</i>	<i>To Actor</i>
Route Traffic	ServiceProvider			X	RouteTraffic	ServiceProvider

<i>Contract/Regulation</i>	<i>Impact of Contract/Regulation on Function</i>
Service Level Agreement between Network Service Provider and Users regarding performance and availability	NM activities need to ensure that these SLA are met through proper network configuration, routing configuration, setting priority levels if possible, determining alternative routes, etc. Examples of SLAs are ability to provide a throughput of b KBPS, ability to deliver messages of size less than m bytes within t seconds, a bound on service ability $a\%$ of the time, etc.

<i>Policy</i>	<i>From Actor</i>	<i>May</i>	<i>Shall Not</i>	<i>Shall</i>	<i>Description (verb)</i>	<i>To Actor</i>
Provide a throughput of b KBPS	Customer			X	Provide a throughput of b KBPS	ServiceProvider
Deliver messages of size less than m bytes within t seconds	Customer			x		ServiceProvider
Provide a bound on service ability $a\%$ of the time	Customer			x		ServiceProvider

<i>Contract/Regulation</i>	<i>Impact of Contract/Regulation on Function</i>
SLA's between provider and user/organizations on security.	NM activities need to ensure that these SLA are met through proper network configuration, routing configuration, setting and enforcing security levels if possible, determining security mechanisms, etc.

<i>Policy</i>	<i>From Actor</i>	<i>May</i>	<i>Shall Not</i>	<i>Shall</i>	<i>Description (verb)</i>	<i>To Actor</i>
Limited access to an application by a specified set of users	Customer		X	X	Shall provide services to users within the set. Shall not provide services to users outside the specified list.	ServiceProvider
Encrypt all communications	Customer		x	x		ServiceProvider

<i>Constraint</i>	<i>Type</i>	<i>Description</i>	<i>Applies to</i>

2. Step by Step Analysis of Function

Describe steps that implement the function. If there is more than one set of steps that are relevant, make a copy of the following section grouping (Preconditions and Assumptions, Steps normal sequence, and Steps alternate or exceptional sequence, Post conditions)

2.1 Steps to implement function

Name of this sequence

2.1.1 Preconditions and Assumptions

Describe conditions that must exist prior to the initiation of the Function, such as prior state of the actors and activities

Identify any assumptions, such as what systems already exist, what contractual relations exist, and what configurations of systems are probably in place

Identify any initial states of information exchanged in the steps in the next section. For example, if a purchase order is exchanged in an activity, its precondition to the activity might be 'filled in but unapproved'.

2.1.2 Steps – Normal Sequence

Describe the normal sequence of events, focusing on steps that identify new types of information or new information exchanges or new interface issues to address. Should the sequence require detailed steps that are also used by other functions, consider creating a new “sub” function, then referring to that “subroutine” in this function. Remember that the focus should be less on the algorithms of the applications and more on the interactions and information flows between “entities”, e.g. people, systems, applications, data bases, etc. There should be a direct link between the narrative and these steps.

The numbering of the sequence steps conveys the order and concurrency and iteration of the steps occur. Using a Dewey Decimal scheme, each level of nested procedure call is separated by a dot '.'. Within a level, the sequence number comprises an optional letter and an integer number. The letter specifies a concurrent sequence within the next higher level; all letter sequences are concurrent with other letter sequences. The number specifies the sequencing of messages in a given letter sequence. The absence of a letter is treated as a default 'main sequence' in parallel with the lettered sequences.

Sequence 1:

```
1.1 - Do step 1
1.2A.1 - In parallel to activity 2 B do step 1
1.2A.2 - In parallel to activity 2 B do step 2
1.2B.1 - In parallel to activity 2 A do step 1
1.2B.2 - In parallel to activity 2 A do step 2
```

- 1.3 - Do step 3
- 1.3.1 - nested step 3.1
- 1.3.2 - nested step 3.2

Sequence 2:

- 2.1 - Do step 1
- 2.2 - Do step 2

2.1.2.1 Performance Management

This table shows the sequence of events for performance management scenario. Step 1.5 shows an example recovery action.

#	Event	Primary Actor	Name of Process/Activity	Description of Process/Activity	Information Producer	Information Receiver	Name of Info Exchanged	Additional Notes	IECSA Environments
#	Triggering event: Identify the name of the event. ²	What other actors are primarily responsible for the Process/Activity. Actors are defined in section 1.5.	Label that would appear in a process diagram. Use action verbs when naming activity.	Describe the actions that take place in active and present tense. The step should be a descriptive noun/verb phrase that portrays an outline summary of the step. "If...Then...Else" scenarios can be captured as multiple Actions or as separate steps.	What other actors are primarily responsible for Producing the information. Actors are defined in section 1.5.	What other actors are primarily responsible for Receiving the information. Actors are defined in section 1.5. (Note – May leave blank if same as Primary Actor)	Name of the information object. Information objects are defined in section 1.6	Elaborate architectural issues using attached spreadsheet. Use this column to elaborate details that aren't captured in the spreadsheet.	Reference the applicable IECSA Environment containing this data exchange. Only one environment per step.
1.1		EnterpriseManager	Get Performance Data	NMS manager requests performance data.	EnterpriseManager	EnergyManagementSystem	GetRequest		Control Center / Corporations
1.2		EnergyManagementSystem	Get Performance Data	EnergyManagementSystem polls data from manageddevice	EnergyManagementSystem	ManagedDevice	GetRequest		Intra-Control Center

² Note – A triggering event is not necessary if the completion of the prior step leads to the transition of the following step.

#	Event	Primary Actor	Name of Process/Activity	Description of Process/Activity	Information Producer	Information Receiver	Name of Info Exchanged	Additional Notes	IECSA Environments
1.3		ManagedDevice	Provide performanceData	EnergyManagementSystem gets data from manageddevice	ManagedDevice	EnergyManagementSystem	PerformanceData		Intra-Control Center
1.4		EnergyManagementSystem	Post Results on Management Client	Post results	EnergyManagementSystem	EnterpriseManager	PerformanceData		Control Center / Corporations
1.5		EnterpriseManager	Change Configuration	The manager detects problem, find a solution, that may affect the same or another managed device	EnterpriseManager	EnergyManagementSystem	Configuration Data	If no problem is identified, the function stops.	Control Center / Corporations
1.6		EnergyManagementSystem	Change Configuration	EnergyManagementSystem passes the configuration data to the device in the proper format.	EnergyManagementSystem	ManagedDevice2	Configuration Data		Intra-Control Center

2.1.1 Post-conditions and Significant Results

Describe conditions that must exist at the conclusion of the Function. Identify significant items similar to that in the preconditions section.

Describe any significant results from the Function

<i>Actor/Activity</i>	<i>Post-conditions Description and Results</i>

2.2 Architectural Issues in Interactions

Elaborate on all architectural issues in each of the steps outlined in each of the sequences above. Reference the Step by number..



Microsoft Excel
Worksheet

3. Auxiliary Issues

3.1 References and Contacts

Documents and individuals or organizations used as background to the function described; other functions referenced by this function, or acting as “sub” functions; or other documentation that clarifies the requirements or activities described. All prior work (intellectual property of the company or individual) or proprietary (non-publicly available) work must be so noted.

- [**ATMF 94**] ATM Forum, "Customer Network Management (CNM) for ATM Public Network Service," ATMF Specification af-nm-0019.000, Oct, 1994
- [**ATMF 96**] ATM Forum, "Integrated Local Mgmt. Interface (ILMI) Ver. 4.0," ATMF Specification af-ilmi-0065.000, Sep, 1996.
- [**ATMF 97**] ATM Forum, "ATM Remote Monitoring SNMP MIB," ATMF Specification af-nm-test-0080.000, July 1997
- [**ATMF 98**] ATM Forum, "SNMP M4 Network Element View MIB," ATMF Specification af-nm-0095.001, July 1998
- [**ATMF 99a**] ATM Forum, "Network Management M4 Security Requirements and Logical MIB," ATMF Specification af-nm-0103.000, Jan, 1999
- [**ATMF 99b**] ATM Forum, "M4 Interface Requirements and Logical MIB: ATM Network View Version 2," ATMF Specification af-nm-0058.001, May, 1999
- [**ATMF 99c**] ATM Forum, "Auto-configuration of PVCs Specification," ATMF Specification af-nm-0122.000, May 1999
- [**ATMF 99d**] ATM Forum, "CMIP Specification for the M4 Interface: ATM Network Element View, Version 2," ATMF Specification af-nm-0027.001, July, 1999
- [**ATMF 00**] ATM Forum, "ATM Usage Measurement Requirements," ATMF Specification af-nm-0154.000, November 2000
- [**ATMF 01a**] ATM Forum, "Requirements and Logical MIB for Management of Path and Connection Trace," ATMF Specification, af-nm-0153.000, April, 2001
- [**ATMF 01b**] ATM Forum, "CORBA Specification for M4 Interface: Network View", ATMF Letter Ballot Document: fb-nm-0166.000, Apr 2001.
- [**ATMF 02**] ATM Forum, "M4 Interface: ATM Network View, CORBA MIB, Version 2," ATMF Specification af-nm-0185.000, August, 2002
- [**ATMF 03**] ATM Forum, "ATM Performance Management Bulk, Data File Structure," ATMF Specification af-nm-0194.000, April, 2003
- [**Bell 93**] Bellcore TA-NWT-001114, Generic Requirements for Operations Interfaces Using OSI Tools: ATM/Broadband Network Management, Issue 2, October 1993.
- [**Bell 96**] GR-2869-CORE, *Generic Requirements for Operations Based on the Telecommunications Management Network (TMN) Architecture*, Issue 2, Bellcore, October 1996.
- [**Bell 94**] SR-TSV-002690, *Requirements for an EML Platform Environment*, Bellcore, Issue 1, March 1994.
- [**Bell 96**] *Network Management Layer to Element Manager Interface Description*, Bellcore, February 1996.
- [**Bell 00**] Bellavista P., Corradi A., Stefanelli C., "An Integrated Management Environment for Network Resources and Services," IEEE Journal on Selected Areas in Communications, Vol. 18, No. 5, May 2000

- [**Casa 00**] Casassa M., Baldwin A., Goh C., "POWER Prototype: Towards Integrated Policy-Based Management," IEEE/IFIP Network Operations and Management Symposium, 2000.
- [**Chei 98**] Cheikhrouhou M. M., Conti P., Labetoulle J., "Intelligent Agents in Network Management: A State-of-the-art," 1998
- [**CORBA**] CORBA www.omg.org, www.corba.org
- [**Dobs 89**] Dobson J.E., McDermid J.A., "A Framework for Expressing Models of Security Policy," IEEE Symposium on Security & Privacy, May 1989, Oakland, CA, 1989.
- [**DOCS OSSI**] Data-Over-Cable Service Interface Specifications DOCSIS 2.0 - Operations Support System Interface Specification, SP-OSSIV2.0-104-030730, July 2003.
- [**DSL F TR005**] DSL Forum "ADSL Network Element Management", DSL Forum Technical Report TR-005, March 1998.
- [**DSL F TR022**] DSL Forum, "The Operation of ADSL-based Networks," DSL Forum Technical Report TR-022, August 1999.
- [**DSL F TR030**] DSL Forum, "ADSL EMS to NMS Functional Requirements," DSL Forum Technical Report TR-030, Feb 2000.
- [**DSL F TR035**] DSL Forum, "Protocol Independent Object Model for ADSL EMS-NMS Interface," DSL Forum Technical Report: TR-035, March 2000.
- [**DSL F TR041**] DSL Forum, "CORBA Specification for ADSL EMS-NMS Interface," DSLF Technical Report TR-041, June 2001.
- [**DSL F TR046**] DSL Forum, "Auto-Configuration Architecture & Framework", DSL Forum Technical Report, TR-046, February 2002.
- [**Enns 03**] R. Enns, "XMLCONF Configuration Protocol", IETF Internet Draft draft-enns-xmlconf-spec-00.txt, Feb. 2003.
- [**Gins 99a**] D. Ginsburg, *ATM Solutions for Enterprise Internetworking, 2nd Edition*, Addison Wesley, 1999.
- [**Gins 99b**] D. Ginsbury, *Implementing ADSL*, Addison Wesley, 1999.
- [**Gold 95**] Goldszmidt G., Yemini Y., "Distributed Management by Delegation," Procs. Of the 15th International Conference on Distributed Computing Systems, June 1995
- [**Hege 99**] Hegering H., Abeck S., Neumair B., *Integrated Management of Network Systems*, Morgan Kaufmann Publishers, Inc. 1999
- [**IEEE**] IEEE www.ieee.org
- [**IETF**] IETF www.ietf.org.
- [**IPDR 02**] "Network Data Management – Usage (NDM-U) For IP-Based Services", Version 3.1, IPDR.org, April 15, 2002.
- [**ISO**] ISO www.iso.ch
- [**ITU G9971**] ITU-T Draft Recommendation G.997.1, "Physical Layer Management for Digital Subscriber Line (DSL) Transceivers", October 1998.
- [**ITU M3010**] ITU-T Recommendation M.3010: "Principles for a Telecommunications Management Network", October 1992.
- [**ITU M3100**] ITU-T Recommendation M.3100: "Generic Network Information Model Version 2", March 1995.
- [**ITU M3120**] ITU-T, SG4, Recommendation M.3120, "CORBA Generic Network and NE Level Information Model," October 2001.
- [**ITU Q8221**] ITU-T, SG4, Recommendation Q.822.1, "CORBA-based TMN Performance Management Service", October 2001.
- [**ITU X720**] ITU-T Recommendation X.720, "Information Technology – Open Systems Interconnection – Structure of Management Information: Management Information Model," January 1992.
- [**ITU X721**] ITU-T Recommendation X.721, "Information Technology - Open Systems Interconnection - Structure of Management Information - Part 2: Definition of Management Information", February 1992.
- [**JMX**] JMX www.java.com

- [**Ju 01**] Ju H., Choi M., Hong J., "EWS-Based Management Application Interface and Integration Mechanisms for Web-Based Element Management," Journal of Network and Systems Management, Vol.9, No.1, 2001
- [**Knig 99**] Knight G., Hazemi R., "Mobile Agent-Based Management in the INSERT Project," Journal on Network and Systems Management, Vol.7, 1999
- [**Koch 01**] Koch F. L., Westphall C. B., "Decentralized Network Management Using Distributed Artificial Intelligence," Journal of Network and Systems Management, Vol.9, No.4, Dec. 2001
- [**Lang 97**] Lange, D., "Java Aglets Application Programming Interface (J-AAPI)," IBM white paper, Feb. 1997. (www.trl.ibm.com/aglets/JAAPI-whitepaper.htm)
- [**Lupu 99**] Lupu E., Sloman M., "Conflicts in Policy-Based Distributed Systems Management," IEEE Transactions on Software Engineering, Vol. 25, No. 6, Nov. 1999.
- [**Mani 00**] Subramanian, Mani, *Network Management, Principles and Practice*, Addison Wesley, 2000.
- [**Mart 98**] Martin-Flatin J., "Push vs. Pull in Web-Based Network Management," Technical Report SSC/1998/002, Swiss Federal Institute of Technology Lausanne, 1998
- [**Mart 99**] Martin-Flatin J. P., Znaty S., Hubaux J. P., "A Survey of Distributed Enterprise Network and Systems Management Paradigms," Journal of Network and Systems Management, Vol.7, No.1, 1999
- [**Moff 93**] Moffett J., Sloman M., Policy Hierarchies for Distributed Systems Management, IEEE Journal on Selected Areas in Communication, Vol. 11, No. 9, Dec. 1993.
- [**Nade 03**] T. D. Nadeau, *MPLS Network Management - MIBs, Tools and Techniques*, Morgan Kaufmann, 2003.
- [**OMG 99**] The Object Management Group (OMG), "The Common Object Request Broker: Architecture and Specification", OMG Document: formal/99-10-07, Revision 2.3.1, October 1999.
- [**Proz 97**] Prozeller P., "TINA and the Software Infrastructure of the Telecom Network of the Future," Journal on Network and System Management, Vol.5, Dec. 1997
- [**Raou 02**] Raouf Boutaba, Jin Xiao, "Network Management: State of the Art," Communication Systems: The State of the Art (IFIP World Computer Congress), p.g.127-146, 2002.
- [**RFC 1155**] K. McCloghrie, M. Rose, "Structure and Identification of Management Information for TCP/IP-based Internets," IETF RFC 1155, May 1990.
- [**RFC 1157**] Schoffstall, M., Fedor, M., Davin, J. and Case, J., A Simple Network Management Protocol (SNMP), IETF RFC 1157, May, 1990
- [**RFC 1212**] K. McCloghrie, M. Rose, "Concise MIB Definitions", IETF RFC 1212, March, 1991.
- [**RFC 1213**] K. McCloghrie and M. Rose. Management Information Base for Network Management of TCP/IP-base Internets: MIB-II, IETF RFC 1213, and March 1991
- [**RFC 1215**] Rose, M.T. "A Convention for Defining Traps for use with the SNMP", IETF RFC 1215, March 1991.
- [**RFC 1224**] L. Steinberg. Techniques for Managing Asynchronously Generated Alerts, IETF RFC 1224, May, 1991
- [**RFC 1406**] F. Baker, J. Watt, "Definitions of Managed Objects for the DS1 and E1 Interface Types", IETF RFC 1406, Jan 1993.
- [**RFC 1407**] T. Cox, K. Tesink, "Definitions of Managed Objects for the DS3/E3 Interface Type", IETF RFC 1407, Jan 1993.
- [**RFC 1441**] J. Case, K. McCloghrie, M. Rose, S. Waldbusser, "Introduction to version 2 of the Internet-standard Network Management Framework", IETF RFC 1441, May 1993.

- [RFC 1442] J. Case, K. McCloghrie, M. Rose, S. Waldbusser, “Structure of Management Information for version 2 of the Simple Network Management Protocol (SNMPv2)”, IETF RFC 1442, May 1993.
- [RFC 1443] J. Case, K. McCloghrie, M. Rose, S. Waldbusser, “Textual Conventions for version 2 of the Simple Network Management Protocol (SNMPv2)”, IETF RFC 1443, May 1993.
- [RFC 1444] J. Case, K. McCloghrie, M. Rose, S. Waldbusser, “Conformance Statements for version 2 of the Simple Network Management Protocol (SNMPv2)”, IETF RFC 1444, May 1993.
- [RFC 1445] J. Davin, K. McCloghrie, “Administrative Model for version 2 of the Simple Network Management Protocol (SNMPv2)”, IETF RFC 1445, May 1993.
- [RFC 1446] J. Galvin, K. McCloghrie, “Security Protocols for version 2 of the Simple Network Management Protocol (SNMPv2)”, IETF RFC 1446, May 1993.
- [RFC 1447] K. McCloghrie, J. Galvin, “Party MIB for version 2 of the Simple Network Management Protocol (SNMPv2)”, IETF RFC 1447, May 1993.
- [RFC 1448] J. Case, K. McCloghrie, M. Rose, S. Waldbusser, “Protocol Operations for version 2 of the Simple Network Management Protocol (SNMPv2)”, IETF RFC 1448, May 1993.
- [RFC 1449] J. Case, K. McCloghrie, M. Rose, S. Waldbusser, “Transport Mappings for version 2 of the Simple Network Management Protocol (SNMPv2)”, IETF RFC 1449, May 1993.
- [RFC 1450] J. Case, K. McCloghrie, M. Rose, S. Waldbusser, “Management Information Base for version 2 of the Simple Network Management Protocol (SNMPv2)”, IETF RFC 1450, May 1993.
- [RFC 1451] J. Case, K. McCloghrie, M. Rose, S. Waldbusser, “Manager to Manager Management Information Base”, IETF RFC 1451, May, 1993.
- [RFC 1452] J. Case, K. McCloghrie, M. Rose, S. Waldbusser, “Coexistence between version 1 and version 2 of the Internet-standard Network Management Framework”, IETF RFC 1452, May 1993.
- [RFC 1493] E. Decker, P. Langille, A. Rijsinghani, and K. McCloghrie., Definitions of Managed Objects for Bridges, IETF RFC 1493, July, 1993
- [RFC 1573] K. McCloghrie, F. Kastenholz, “Evolution of the Interfaces Group of MIB-II”, IETF RFC 1573, Jan 1994.
- [RFC 1595] T. Brown, K. Tesink, “Definitions of Managed Objects for the SONET/SDH Interface Type”, IETF RFC 1595, March 1994.
- [RFC 1695] M. Ahmed and K. Tesink, “Definitions of Managed Objects for ATM Management, Version 8.0 using SMIV2”, IETF RFC 1695, August 1994.
- [RFC 1757] Waldbusser S., Remote Network Monitoring Management Information Base., IETF RFC 1757, Feb. 1995
- [RFC 1901] Case, J., McCloghrie, K., Rose, M. and S. Waldbusser, “Introduction to Community-based SNMPv2”, IETF RFC 1901, January 1996.
- [RFC 1903] Case, J., McCloghrie, K., Rose, M., and S. Waldbusser, “Textual Conventions for Version 2 of the Simple Network Management Protocol (SNMPv2)”, IETF RFC 1903, January 1996.
- [RFC 1905] Case, J., McCloghrie, K., Rose, M. and S. Waldbusser, “Protocol Operations for Version 2 of the Simple Network Management Protocol (SNMPv2)”, IETF RFC 1905, January 1996.
- [RFC 1906] Case, J., McCloghrie, K., Rose, M. and S. Waldbusser, “Transport Mappings for Version 2 of the Simple Network Management Protocol (SNMPv2)”, IETF RFC 1906, January 1996

- [RFC 1907] Case, J., McClooghrie, K., Rose, M. and S. Waldbusser, "Management Information Base for Version 2 of the Simple Network Management Protocol (SNMPv2)", IETF RFC 1907, January 1996.
- [RFC 2011] K. McClooghrie, "Category: Standards Track SNMPv2 Management Information Base for the Internet Protocol using SMIV2", IETF RFC 2011, November 1996
- [RFC 2013] K. McClooghrie, "Category: Standards Track SNMPv2 Management Information Base for the User Datagram Protocol using SMIV2", IETF RFC 2013, November 1996
- [RFC 2570] J. Case, R. Mundy, D. Partain, B. Stewart, "Introduction to Version 3 of the Internet-standard Network Management Framework", IETF RFC 2570, April 1999
- [RFC 2571] Harrington, D., Presuhn, R. and B. Wijnen, "An Architecture for Describing SNMP Management Frameworks", IETF RFC 2571, April 1999.
- [RFC 2572] Case, J., Harrington, D., Presuhn, R. and B. Wijnen, "Message Processing and Dispatching for the Simple Network Management Protocol (SNMP)", IETF RFC 2572, April 1999
- [RFC 2573] Levi, D., Meyer, P. and B. Stewart, "SNMP Applications", IETF RFC 2573, April 1999.
- [RFC 2574] Blumenthal, U. and B. Wijnen, "The User-Based Security Model for Version 3 of the Simple Network Management Protocol (SNMPv3)", IETF RFC 2574, April 1999
- [RFC 2575] Wijnen, B., Presuhn, R. and K. McClooghrie, "View-based Access Control Model for the Simple Network Management Protocol (SNMP)", IETF RFC 2575, April 1999
- [RFC 2576] R. Frye, D. Levi, S. Routhier, B. Wijnen, "Coexistence between Version 1, Version 2, and Version 3 of the Internet-Standard and Network Management Framework", IETF RFC 2576, March 2000.
- [RFC 2578] McClooghrie, K., Perkins, D., Schoenwaelder, J., Case, J., Rose, M. and S. Waldbusser, "Structure of Management Information Version 2 (SMIV2)", IETF RFC 2578, April 1999
- [RFC 2579] McClooghrie, K., Perkins, D., Schoenwaelder, J., Case, J., Rose, M. and S. Waldbusser, "Textual Conventions for SMIV2", IETF RFC 2579, April 1999
- [RFC 2580] McClooghrie, K., Perkins, D., Schoenwaelder, J., Case, J., Rose, M. and S. Waldbusser, "Conformance Statements for SMIV2", IETF RFC 2580, April 1999
- [RFC 2662] B. Bathrick, F. Ly, "Definitions of Managed Objects for the ADSL Lines", IETF RFC 2662, August 1999.
- [RFC 2665] J. Flick, J. Johnson, "Definitions of Managed Objects for the Ethernet-like Interface Types", August 1999
- [RFC 2669] M. St. Johns, "DOCSIS Cable Device MIB Cable Device Management Information Base for DOCSIS compliant Cable Modems and Cable Modem Termination Systems", August 1999
- [RFC 2670] M. St. Johns, "Radio Frequency (RF) Interface Management Information Base for MCNS DOCSIS compliant RF interfaces", August 1999
- [RFC 2748] D. Durham, Ed. "The COPS (Common Open Policy Service) Protocol," IETF RFC 2748, Jan. 2000.
- [RFC 2786] M. St. Johns, "Diffie-Helman USM Key Management Information Base and Textual Convention", IETF RFC 2786, Aug, 1999
- [RFC 2863] K. McClooghrie, F. Kastenholz, "The Interfaces Group MIB", June 2000.
- [RFC 2933] McClooghrie, K., Farinacci, D., Thaler, D., "Internet Group Management Protocol MIB", IETF RFC 2933

[RFC 3083] R. Woundy, "Baseline Privacy Interface Management Information Base for DOCSIS Compliant Cable Modems and Cable Modem Termination Systems", RFC 3083, March 2001.

[RFC 3084] Chan K, et al, "COPS Usage for Policy Provisioning," IETF RFC 3084, March 2001.

[RFC 3483] D. Rawlins et al, "Framework for Policy Usage Feedback for Common Open Policy Service with Policy Provisioning (COPS-PR)," March 2003.

[Roge 02] Rogerson D., Inside COM, Redmond, WA, Microsoft, 1997

[Stra 96] Straber M., Baumann J., Fohl F., "Mole – A Java Based Mobile Agent System," 10th European Conference on Object-Oriented Programming ECOOP'96. Jul. 1996

[Thom 98] Thompson J., "Web-based Enterprise Management Architecture," IEEE Communications Magazine, Mar. 1998

[WBEM] www.dmtf.org

[Wool 95] Wooldridge M., Jennings N. R., "Intelligent Agents: Theory and Practice, The Knowledge Engineering Review," Vol. 10, No.2, 1995

3.2 Action Item List

As the function is developed, identify issues that still need clarification, resolution, or other notice taken of them. This can act as an Action Item list.

ID	Description	Status
----	-------------	--------

3.3 Revision History

For reference and tracking purposes, indicate who worked on describing this function, and what aspect they undertook.

No	Date	Author	Description
01.			

This page intentionally left blank.

Demand Response – Utility Commanded Load Control

1 Descriptions of Function

All prior work (intellectual property of the company or individual) or proprietary (non-publicly available) work should be so noted.

1.1 Function Name

Name of Function

Demand Response – Utility Commanded Load Control

1.2 Function ID

IECSA identification number of the function

M-2.1,M-3,M-4.5,M-5,G-1,G-9.1,T-6.21,L-10,L-10.1,L-10.2,C-5,C-7

1.3 Brief Description

Describe briefly the scope, objectives, and rationale of the Function.

Many Energy Service Providers and Market Operators administer customer side Demand Response and Load Control programs to ensure grid stability and stable operation during times of peak demand or system emergencies arising from generator outages or transmission and/or distribution constraints. With some programs, the customer – either residential or commercial - reduces the required load upon instruction from the Energy Service Provider or Market Operator. With other programs, the Energy Service Provider, Market Operator, or a Curtailment Service Provider remotely reduces the load. Some of these programs are conducted on a voluntary basis, where the customer can opt to maintain the level or load, or mandatory, where the customer either will be dropped off the system or will incur significant financial penalties for noncompliance. The customer may or may not realize benefits from the program, such as discounted rates. Some programs may be mandated to enable the Energy Service Provider to provide electric service to the customer in areas where there are transmission or distribution constraints. This function focuses on Demand Response/Consumer Load Control that is non responsive to price – pricing signals are not sent to the customer. Communication systems play a key role in this function as in the consumer control load configuration, instructions must be sent to the customer to reduce or eliminate load and verification of compliance/noncompliance must be obtained by the Energy Service Provider or Market Operator. In the configuration where the Energy Service Provider, Market Operator or CSP controls the load, commands must be sent to equipment at the customer site that will cycle down or cease operation. Verification of successful action must also be obtained.

1.4 Narrative

A complete narrative of the Function from a Domain Expert's point of view, describing what occurs when, why, how, and under what conditions. This will be a separate document, but will act as the basis for identifying the Steps in Section 2.

A typical day-in-the-life scenario is as follows (note that the discussion is marked up with numbers that are used later in the analysis to derive requirements from the scenario):

Utilities with significant periods of peak demand often establish and administer demand response/load control program where residential and commercial customers may, in exchange for discounted rates, agree to, on a voluntary or mandatory basis, reduce or cycle down load. Utilities, especially those with a customer base operating significant cooling and/or electric heating loads – primarily heat pumps, and electric water heating loads, are implementing programs centered around these loads to address periods of peak demand – extremely hot or cold days or times of system emergency – where a generator may be removed from service for maintenance or where the transmission and/or distribution system may be constrained. These utilities operate in markets where customer participation in Real Time Pricing programs has not been authorized by the state regulatory body or implemented by the utility.

Inside this program, residential and commercial customers sign up for a program where they receive discounted rates for participation. The customer may choose to opt out of participating in a particular instance, but will be compelled to pay a peak demand penalty for nonparticipation. The utility installs equipment at the customer meter to receive commands from the utility system operator. These commands operate a load control transponder, which either interfaces with the thermostat controlling air conditioning/heating equipment or operates a breaker closing the circuit powering water heaters and/or pool pumps.

⁽¹⁾At the onset of a day where the weather is forecast to be extremely hot or cold or when it is known the possibility exists for a system emergency, the SystemModeler runs models to determine where and when times of peak demand will occur. This modeling involves clearly defined parameters such as weather, tracked seasonal load, load availability factors, and customer load served by the transmission and/or distribution system. It is determined that with the available amount of bulk power and the system experiencing some transmission constraints due to maintenance issues or locations of some loads in relation to the infrastructure, that a peak demand event will occur requiring reduction of a certain amount of customer load.

⁽²⁾Under normal operating conditions, the utility provides two hours' notice to customer account representatives and customer service representatives that load reduction is required and will occur. In a system emergency where a generator trips offline or lightning or some other event causes the transmission and/or distribution infrastructure to be overloaded or unavailable, fifteen minutes' notice is provided. Other utility personnel are alerted.

⁽³⁾When the peak demand period is about to begin or when the system emergency occurs, the utility control center sends a command via the utility's internal frame relay system to the distribution substations, where a substation controller sends a command via Power Line Communication (PLC) to a LoadControlTransponder (LCT). The system operator can target individual substations to address the amount of load reduction required and the operational situation of the utility system.

⁽⁴⁾Commands are broadcast out to the substation controllers, which then broadcast to all LCTs connected to it. The load control commands are sent out in staggered fashion to manage information flow across the utility system. "Thermostat Setback," "Turn Off," "Turn On" and "Check Transponder Health" are the commands sent out. The transponder has an internal counter that counts the off/on commands and whether the relays were successfully opened. At the onset of the program, the utility downloaded data from the counters to determine system health and to validate the models used to predict system operation, peak demand, and needed load reduction. The utility has since abandoned this, preferring to rely on automated, staggered interrogation of the transponders to verify transponder health. This interrogation does not involve any turning the relays on or off.

⁽⁵⁾The relays control thermostats, water heaters, and swimming pool pumps. This customer equipment is located at both residential and commercial locations and was selected for its predicted load patterns and ease of remote control. Customers can choose to override the transponder, but will pay a peak demand penalty if they do so.

⁽⁶⁾The utility verifies customer participation via acknowledgement of a successful “Turn Off” command. After each instance of load reduction, the utility conducts an assessment of how many MW of load was reduced and uses this information, along with a review of the command logs and receipt of successful “Turn On” and Turn Off” commands to refine the model used to ascertain when the load control programs needs to be activated, how it needs to be implemented across the service territory, and operating condition of the communications and control equipment.

1.5 Actor (Stakeholder) Roles

Describe all the people (their job), systems, databases, organizations, and devices involved in or affected by the Function (e.g. operators, system administrators, technicians, end users, service personnel, executives, SCADA system, real-time database, RTO, RTU, IED, power system). Typically, these actors are logically grouped by organization or functional boundaries or just for collaboration purpose of this use case. We need to identify these groupings and their relevant roles and understand the constituency. The same actor could play different roles in different Functions, but only one role in one Function. If the same actor (e.g. the same person) does play multiple roles in one Function, list these different actor-roles as separate rows.

<i>Grouping(Community)</i>		<i>Group Description</i>
Top Level Actors		High-level actors who have significant stake on the Demand Response/Load Management function.
<i>Actor Role Name</i>	<i>Actor Type (person, device, system etc.)</i>	<i>Role Description</i>
Energy Service Provider	organization	Responsible for day to day operation of the demand response/load control program
PublicUtilityCommission	organization	Supervises implementation of demand response/load control program with direct oversight of rates and penalties

<i>Grouping(Community)</i>		<i>Group Description</i>
CustomerInformationSystem	Server	Stores information about customers participating in the program with details on participating history, loads to be controlled, and whether customer has previously negotiated to opt out of program in certain situation. Also contains customer billing data including any demand penalties and rate scheduled
SystemDemandModeler	System	Conducts daily modeling to determine whether demand response/load control is required. Contains databases on weather conditions, generation availability, transmission and distribution system constraints, load availability, predicted control patterns, and details on performance of individual substation control units and load control transponders
SystemModeler	Person	Operates system demand modeling capability and lets control room personnel and customer service personnel know whether load control will be needed according to the model.
ControlRoomOperator	Person	Individual responsible for activation of automated load control notification and implementation
Notification and ControlSystem	System	Upon receipt of command from control room operator, sends either 2 hour notification or 15 minute notification and then sends commands out to substation control units
Customer Account/Service Representative	Person	Receives notification from system that load control is needed and/or imminent and handles calls from customers about situation - may in time be able to provide notification to key or sensitive customers

<i>Grouping(Community)</i>		<i>Group Description</i>
SubstationController	Device	Receives commands from control center and sends commands out to load control transponders to either cycle thermostats or shut off water heaters and pool pumps
LoadControlTransponder	Device	Upon receipt from substation control unit, either transmits command to thermostat or to water heater or pool pump. Sends notification of successful or unsuccessful execution of command back to substation control unit
Remotely-ControlledThermostatDevice	Device	Upon receipt of command from LoadControlTransponder, cycles space cooling or heating down or off
RemotelyControllerCircuitBreakerDevice	Device	Upon receipt of command from LoadControlTransponder, shuts off power to water heater and/or pool pump
Frame Relay Network	System	Carries load control commands from control room to substation control unit
TransmissionSystemOperator	System	Provides power system configuration and real-time data to system demand modeler
TransmissionSystem	Power equipment	Transmission power system equipment
TransmissionSCADASystem	System	System that provides forecast and real-time transmission information to the system demand modeler and control room operator

<i>Grouping(Community)</i>		<i>Group Description</i>
DistributionManagementSystem	System	Provides real-time data to the system demand modeler and control room operator
DistributionSystem	Power equipment	Distribution power system equipment
SCADASystem	System	System that monitors load control as well as providing forecast and real-time distribution information to the system demand modeler and control room operator
MeterDevice	Devices	Collects energy and demand data per time period
Customer	Person	Agrees to participate in program. May or may not at time of system operation choose whether or not to participate
ITPersonnel	Person	Oversees operation of frame relay network and powerline communications system
constraint data		
Distribution outage		
EnergySchedule Database		
EnergySchedule Database database		

<i>Grouping(Community)</i>		<i>Group Description</i>
Generation maintenance/scheduled availability database		
Generation outage		
HistoricLoadForecastDatabase		
HistoricLoadForecastDatabase		
LoadSchedule		
LoadForecaster		
Transmission outage		
WeatherForecastData		
WeatherService		
CustomerServiceRepresentative		

<i>Grouping(Community)</i>		<i>Group Description</i>
Everyone		
Substation control unit database		

Replicate this table for each logic group.

1.6 Information exchanged

Describe any information exchanged in this template.

<i>Information Object Name</i>	<i>Information Object Description</i>
Energy Schedules	EnergyScheduleDatabase submitted to the Utility Control Center and System Modeling
Weather Forecast Data	Information on forecast temperatures – especially high and low temperatures
Generation Outage and Constraint Data	Data containing transmission outage and constraint information
Transmission Outage and Constraint Data	Data containing transmission outage and constraint information
Distribution Outage and Constraint Data	Data containing distribution outage and constraint information
Historical load data	Data containing load levels for similar seasonal parameters – actual demand; temperature; generation, transmission, and distribution system availability

<i>Information Object Name</i>	<i>Information Object Description</i>
Customer Participation Schedule	Tables of customers agreeing to participate in the load control program classified by geographic location (by substation providing control)
Load Schedule	Schedule for Customer Load equipment: turning on and off, cycling, and/or level of load
Customer Load Forecasts	Forecasts of individual customer load that can be controlled
Aggregated Customer Loads	Forecasts of aggregated customer load that can be controlled – broken down by geographical location and substation
Loads Forecast	Load forecasts, based on different inputs and possible operating scenarios
Generation System Data	Generation data, including scheduled outages, operating constraints, and real-time information
TransmissionSystem Data	Transmission power system data, including scheduled outages, transmission constraints, and real-time information
DistributionSystem Data	Distribution power system data, including scheduled outages, distribution constraints, and real-time information
Real-time Monitoring and Control Data	Status, settings, curtailable load requirements, automated on/off commands, automated settings, responses back from substation control units and load control transponders
Real-time Power Systems Operations Data	Loads, generation, A/S, etc.
Meter Data	Energy and demand data per time period
Customer Compliance Data	Any peak demand charges for customers not complying with participation requirements

1.7 Activities/Services

Describe or list the activities and services involved in this Function (in the context of this Function). An activity or service can be provided by a computer system, a set of applications, or manual procedures. These activities/services should be described at an appropriate level, with the understanding that sub-activities and services should be described if they are important for operational issues, automation needs, and implementation reasons. Other sub-activities/services could be left for later analysis.

<i>Activity/Service Name</i>	<i>Activities/Services Provided</i>
Load forecast function	Function uses generation, transmission and distribution information, energy schedules, weather, and past history to forecast loads and ability of system to accommodate them
Weather forecast function	Function uses data to estimate probable weather temperatures, etc.
Load availability function	Function determines the available load capacity based on power system constraints, operational costs, environmental conditions, etc.
Load control modeling function	Function determines extent and operating parameters of load control based on geographic patterns, load forecast and availability, and system operating conditions
Load control aggregation function	Function that aggregates load information from multiple customers and manages the submittal to the utility control center
Notification function	Function sends out 2-hour notification to control room and customer service personnel or 15 minute notice in system emergency situations
Load control implementation function	Function where load control commands are sent out to substation control units, which then relay commands to load control transponders
Equipment control function	Function that adjusts thermostat settings to cycle down space cooling or heating or operate breakers to shut off water heaters or pool pumps
Load control compliance function	Function that transmits successful or unsuccessful execution of control commands back to

<i>Activity/Service Name</i>	<i>Activities/Services Provided</i>
	control center
Load control override function	Function where customer can override automatic setting of thermostat or restore power to water heater and/or pool pump
Demand penalty assessment function	Function where penalty charges are calculated for customers who override the load control commands or are unable to comply due to equipment malfunction

1.8 Contracts/Regulations

Identify any overall (human-initiated) contracts, regulations, policies, financial considerations, engineering constraints, pollution constraints, and other environmental quality issues that affect the design and requirements of the Function.

<i>Contract/Regulation</i>	<i>Impact of Contract/Regulation on Function</i>
Utility operations	FERC and state regulators oversee utility operations
Market tariffs	Peak demand rates
Customer contracts with ESPs	Determines which customers participate in load control programs

<i>Policy</i>	<i>From Actor</i>	<i>May</i>	<i>Shall Not</i>	<i>Shall</i>	<i>Description (verb)</i>	<i>To Actor</i>
Peak Demand Information	Energy Service Provider			X	Provide notification of peak demand period or system emergency to customer service representative	CustomerService Representative
Notification of Imminent Load Control	Energy Service Provider			X	Provide notification of anticipated load control (within 2 hours) or imminent load control (within 15 minutes) to customer account/service representative	CustomerService Representative
Assessment of	Energy Service Provider			X	Provide notification of demand penalties assessed for	Customer

demand penalties					noncompliance in load control activities	
Technology utilization	Energy Service Provider	X			Utilize different methodologies and technologies for providing notification	CustomerService eRepresentative
Delivery	Energy Service Provider	X			Undertake delivery of notification data via reasonable variations in implementation approaches through robust system designs	CustomerService eRepresentative
Data receipt	Customer	X			Can decide whether or not to override load control command	Energy Service Provider
Sensitive data	Everyone		X		Sensitive information must not be accessible by unauthorized entities and must not be prevented from being accessed by authorized entities	Everyone
Equipment	Everyone		X		Changes that are variations in delivery methods must not require field equipment changeouts	Everyone

<i>Constraint</i>	<i>Type</i>	<i>Description</i>	<i>Applies to</i>
Laws of physics	Environmental	Laws of physics for power system operations	All
Technology	Environmental	Technology constraints for providing notification and compliance data	All
Security	Environmental	Security policies and technologies must be established and used to address all security needs at the appropriate/contracted levels	All

2 Step by Step Analysis of Function

Describe steps that implement the function. If there is more than one set of steps that are relevant, make a copy of the following section grouping (Preconditions and Assumptions, Steps normal sequence, and Steps alternate or exceptional sequence, Post conditions)

2.1 Steps to implement function

Name of this sequence.

2.1.1 Preconditions and Assumptions

Describe conditions that must exist prior to the initiation of the Function, such as prior state of the actors and activities

Identify any assumptions, such as what systems already exist, what contractual relations exist, and what configurations of systems are probably in place

Identify any initial states of information exchanged in the steps in the next section. For example, if a purchase order is exchanged in an activity, its precondition to the activity might be 'filled in but unapproved'.

<i>Actor/System/Information/Contract</i>	<i>Preconditions or Assumptions</i>
System operations	Infrastructure has been put in place to implement automated load control
Transmission/distribution operations	Normal power system operations where some customers have contracted to receive and respond to load control signals
Customer equipment	These customers have electric space cooling and/or heating that can be remotely controlled and/or electric water heaters and/or pool pumps that can be remotely shut off

2.1.2 Steps – Normal Sequence

Describe the normal sequence of events, focusing on steps that identify new types of information or new information exchanges or new interface issues to address. Should the sequence require detailed steps that are also used by other functions, consider creating a new “sub” function, then referring to that “subroutine” in this function. Remember that the focus should be less on the algorithms of the applications and more on the interactions and information flows between “entities”, e.g. people, systems, applications, data bases, etc. There should be a direct link between the narrative and these steps.

The numbering of the sequence steps conveys the order and concurrency and iteration of the steps occur. Using a Dewey Decimal scheme, each level of nested procedure call is separated by a dot ‘.’. Within a level, the sequence number comprises an optional letter and an integer number. The letter specifies a concurrent sequence within the next higher level; all letter sequences are concurrent with other letter sequences. The number specifies the sequencing of messages in a given letter sequence. The absence of a letter is treated as a default 'main sequence' in parallel with the lettered sequences.

Sequence 1:

*1.1 - Do step 1
1.2A.1 - In parallel to activity 2 B do step 1
1.2A.2 - In parallel to activity 2 B do step 2
1.2B.1 - In parallel to activity 2 A do step 1
1.2B.2 - In parallel to activity 2 A do step 2
1.3 - Do step 3
1.3.1 - nested step 3.1
1.3.2 - nested step 3.2*

Sequence 2:

*2.1 - Do step 1
2.2 - Do step 2*

#	Event	Primary Actor	Name of Process/Activity	Description of Process/Activity	Information Producer	Information Receiver	Name of Info Exchanged	Additional Notes	IECSA Environments
#	Triggering event? Identify the name of the event. ¹	What other actors are primarily responsible for the Process/Activity? Actors are defined in section 1.5.	Label that would appear in a process diagram. Use action verbs when naming activity.	Describe the actions that take place in active and present tense. The step should be a descriptive noun/verb phrase that portrays an outline summary of the step. "If ...Then...Else" scenarios can be captured as multiple Actions or as separate steps.	What other actors are primarily responsible for Producing the information? Actors are defined in section 1.5.	What other actors are primarily responsible for Receiving the information? Actors are defined in section 1.5. (Note – May leave blank if same as Primary Actor)	Name of the information object. Information objects are defined in section 1.6	Elaborate architectural issues using attached spreadsheet. Use this column to elaborate details that aren't captured in the spreadsheet.	Reference the applicable IECSA Environment containing this data exchange. Only one environment per step.
1.1	Energy Service Provider initiates daily analysis of scheduled load versus available capacity	SystemDemandModeler, SystemModeler	Load forecast Weather forecast Load availability	Forecast power system conditions for that day. Analyze forecast temperature conditions against generation availability, transmission and distribution system conditions, and historical load patterns	EnergyScheduleDatabase, Generation maintenance/scheduled availability database, TransmissionSCADASystem, SCADASystem, WeatherService, HistoricLoadForecastDatabase	ControlRoomOperator	- EnergyScheduleDatabase - WeatherForecastData - Generation outage and constraint data - Transmission outage and constraint data - Distribution outage and constraint data - HistoricLoadForecastDatabase and parameters	- Intra utility communications must be supported - Existing weather protocol and weather format must be used	Control Centers / ESPs

¹ Note – A triggering event is not necessary if the completion of the prior step – leads to the transition of the following step.

#	Event	Primary Actor	Name of Process/Activity	Description of Process/Activity	Information Producer	Information Receiver	Name of Info Exchanged	Additional Notes	IECSA Environments
1.2	Energy Service Provider determines that scheduled load may or will exceed available capacity	SystemDemandModeler, SystemModeler	Load forecast Weather forecast Load availability	Calculate an hourly predicted load versus available capacity schedule	EnergyScheduleDatabase database - Generation maintenance/scheduled availability database - TransmissionSCADASystem system - SCADASystem system - WeatherService - HistoricLoadForecastDatabase	ControlRoomOperator	- EnergyScheduleDatabase - WeatherForecastData - Generation outage and constraint data - Transmission outage and constraint data - Distribution outage and constraint data - HistoricLoadForecastDatabase and parameters	- Intra utility communications must be supported - Existing weather protocol and weather format must be used	Control Centers / ESPs

#	Event	Primary Actor	Name of Process/Activity	Description of Process/Activity	Information Producer	Information Receiver	Name of Info Exchanged	Additional Notes	IECSA Environments
1.3	Energy Service Provider calculates customer load to be curtailed to meet anticipated demand	SystemDemandModeler, SystemModeler	Load forecast Weather forecast Load availability Load control modeling Load control aggregation	Based on additional capacity required, determine extent of customer load to be managed and delineate geographical parameters and notification level	<ul style="list-style-type: none"> - EnergyScheduleDatabase database - Generation maintenance/scheduled availability database - TransmissionSCADASystem system - SCADASystem system - WeatherService - HistoricLoadForecastDatabase - Customer participation database - Substation control unit database 	ControlRoomOperator	<ul style="list-style-type: none"> - EnergyScheduleDatabase - WeatherForecastData - Generation outage and constraint data - Transmission outage and constraint data - Distribution outage and constraint data - HistoricLoadForecastDatabase and parameters - Customer participation schedule - LoadSchedule - Customer load forecasts - Aggregated customer loads - LoadForecaster 	<ul style="list-style-type: none"> - Intra utility communications must be supported - Existing weather protocol and weather format must be used 	Control Centers / ESPs

#	Event	Primary Actor	Name of Process/Activity	Description of Process/Activity	Information Producer	Information Receiver	Name of Info Exchanged	Additional Notes	IECSA Environments
1.4	Energy Service Provider assigns customers to be curtailed by geographic area and by substation	SystemDemandModeler, SystemModeler	Load forecast Weather forecast Load availability Load control modeling Load control aggregation	Taking entire amount of customer load to be managed, assign geographic areas, substations, and individual customers to be curtailed	- Customer participation database - Substation control unit database	ControlRoomOperator, CustomerServiceRepresentative	- Customer participation schedule - LoadSchedule - Customer load forecasts - Aggregated customer loads - LoadForecaster	- Security is major concern	Control Centers / ESPs
1.5	Energy Service Provider sends out notification for Customer Account/ Service Representatives	Notification and ControlSystem	Notification	Energy Service Provider issues automatic notification to CustomerServiceRepresentatives, who, depending on circumstances, receive either two hours' notice or 15 minutes' notice	- Customer participation database - CustomerServiceRepresentative database	CustomerServiceRepresentative	- Customer participation schedule - LoadSchedule - Customer load forecast	• Sent over Energy Service Provider WAN	Customer / ESP
1.6	CustomerServiceRepresentative prepares to field calls from Customers	CustomerServiceRepresentative	Notification	CustomerServiceRepresentatives, upon receipt of notification, prepare to field inquiries from customers whose loads will be controlled	- Customer participation database	Customer	- Customer participation schedule - LoadSchedule - Customer load forecast	- Sent over Energy Service Provider WAN	Customer / ESP

#	Event	Primary Actor	Name of Process/Activity	Description of Process/Activity	Information Producer	Information Receiver	Name of Info Exchanged	Additional Notes	IECSA Environments
1.7	Notification and ControlSystem sends commands to SubstationControllers	Notification and ControlSystem	Load Control Implementation Function	System sends commands out to targeted SubstationControllers to be relayed to LoadControlTransponders	- Customer participation database - Substation control unit database	SubstationController	- Customer participation schedule - LoadSchedule	- Sent over utility WAN - Commands staggered to accommodate available bandwidth	Control Center / Customer Equip
1.8	SubstationController sends commands to LoadControlTransponders	SubstationController	Load Control Implementation Function	SubstationControllers send commands out to individual LoadControlTransponders	LoadControlTransponder database	LoadControlTransponder	- Customer participation schedule - LoadSchedule	- Sent via powerline communication	Control Center / Customer Equip
1.9	LoadControlTransponder issues command to customer thermostat or operates breakers to shut off water heater or pool pump	LoadControlTransponder	Equipment Control Function	LoadControlTransponder issues command to customer thermostat or operates breakers to shut off water heater or pool pump	Command sent from SubstationController	Remotely-ControlledThermostatDevice RemotelyControllerCircuitBreakerDevice	Real-time monitoring and control data	- Command delivered via dedicated wiring inside residence or business	Control Center / Customer Equip
1.10	LoadControlTransponder sends signal back to SubstationController indicating results	LoadControlTransponder	Load Control Compliance Function	LoadControlTransponder sends signal back to SubstationController indicating whether or not command was successfully executed	LoadControlTransponder	SubstationController Notification and ControlSystem SystemDemandModeler	Real-time monitoring and control data		Control Center / Customer Equip

#	Event	Primary Actor	Name of Process/Activity	Description of Process/Activity	Information Producer	Information Receiver	Name of Info Exchanged	Additional Notes	IECSA Environments
1.11	Notification and ControlSystem stores results in database	Notification and ControlSystem	Load Control Modeling Function	Information on system performance used to refine subsequent analyses	LoadControlTransponder, SubstationController	SystemDemand Modeler	Real-time monitoring and control data		Control Centers / ESPs

2.1.3 Steps – Alternative / Exception Sequences

Describe any alternative or exception sequences that may be required that deviate from the normal course of activities. Note instructions are found in previous table.

#	Event	Primary Actor	Name of Process/Activity	Description of Process/Activity	Information Producer	Information Receiver	Name of Info Exchanged	Additional Notes	IECSA Environments
1.9a	LoadControl Transponder Override	Customer	Load Control Override Function	LoadControlTransponder detects active override by customer (as opposed to malfunction). Customer has to activate switch on LCT to override	LoadControlTransponder	SubstationController Notification ControlSystem SystemDemand Modeler CustomerService Representative Meter	Real-time monitoring and control data		Control Center / Customer Equip
1.12	Customer is assessed peak demand charge	Energy Service Provider	Demand Penalty Assessment Function	If it is determined that customer overrode LCT, then a demand penalty is assessed against the customer. Information on this event, as well as any malfunctions, is factored into system modeling	CustomerInformationSystem	Energy Service Provider CustomerService Representative	Meter data Customer Compliance Data		Customer / ESP

2.1.4 Post-conditions and Significant Results

Describe conditions that must exist at the conclusion of the Function. Identify significant items similar to that in the preconditions section.

Describe any significant results from the Function

<i>Actor/Activity</i>	<i>Post-conditions Description and Results</i>
All	System ready to be implemented again in case load continues to need to be curtailed

2.2 Architectural Issues in Interactions

Elaborate on all architectural issues in each of the steps outlined in each of the sequences above. Reference the Step by number..



Microsoft Excel
Worksheet

2.3 Diagram

For clarification, draw (by hand, by Power Point, by UML diagram) the interactions, identifying the Steps where possible.

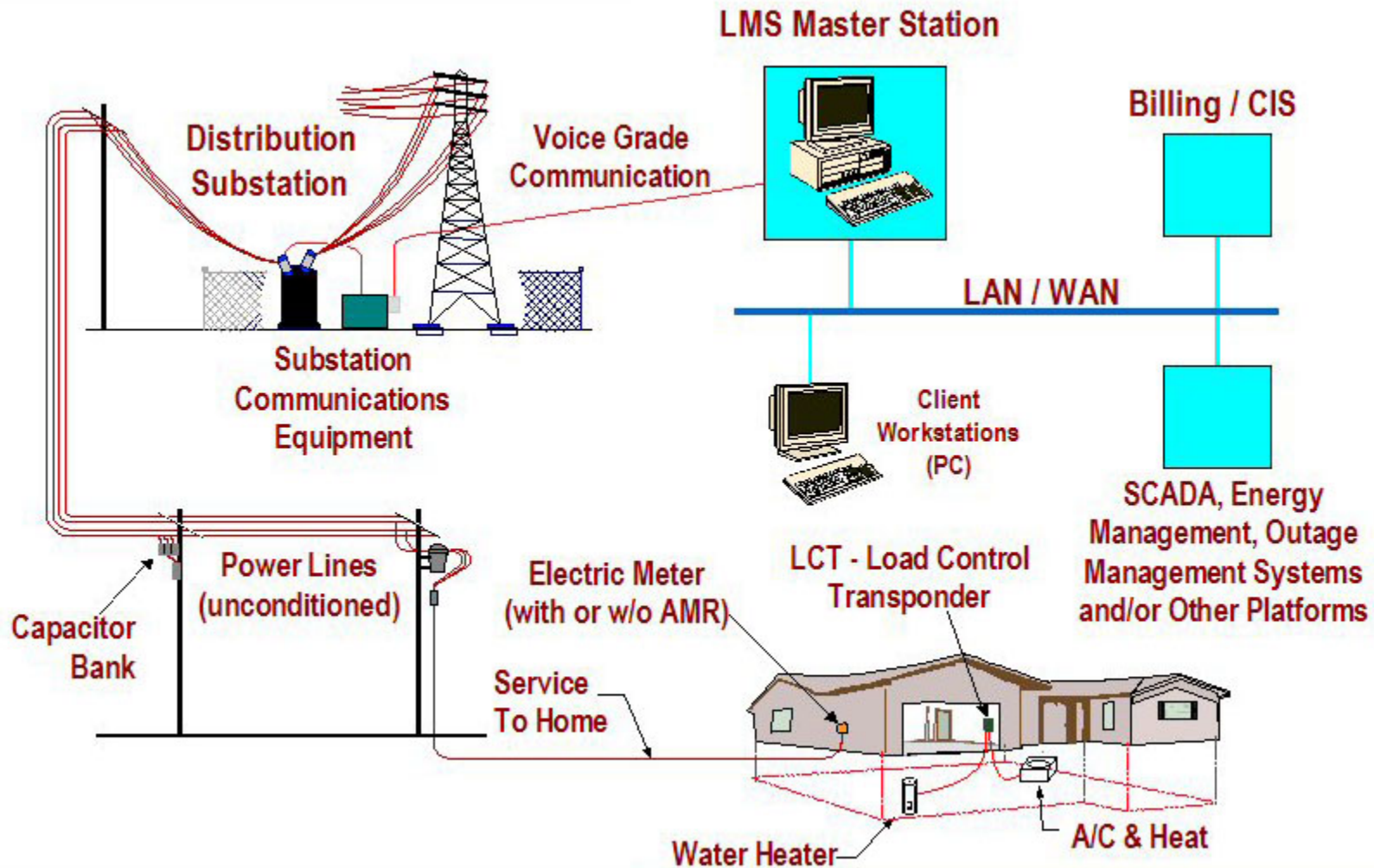

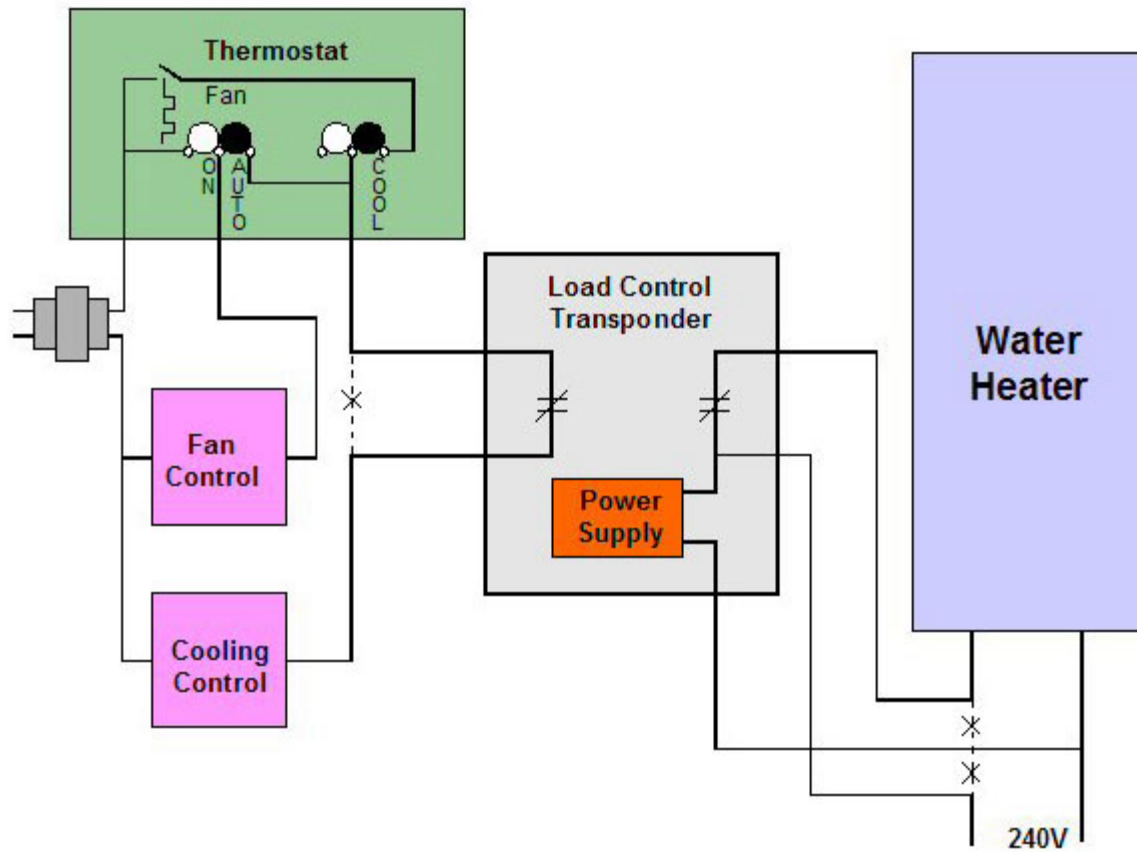

3 Auxiliary Issues

3.1 References and contacts

Documents and individuals or organizations used as background to the function described; other functions referenced by this function, or acting as “sub” functions; or other documentation that clarifies the requirements or activities described. All prior work (intellectual property of the company or individual) or proprietary (non-publicly available) work must be so noted.

ID	Title or contact	Reference or contact information
[1]	Ed Malemezian, Ed Malemezian Consulting	8009 SW Yachtsmans Drive, Stuart, FL 34997 772-286-9831 ed@emalemezian.com
[2]	Brian White, Gulf Power Company	One Energy Place, Pensacola, FL 32520-0231 850-444-6438 BLWHITE@southernco.com

3.2 Action Item List

As the function is developed, identify issues that still need clarification, resolution, or other notice taken of them. This can act as an Action Item list.

ID	Description	Status
[1]		

[2]		
-----	--	--

3.3 Revision History

For reference and tracking purposes, indicate who worked on describing this function, and what aspect they undertook.

No	Date	Author	Description

This page intentionally left blank.

Distributed Generation Aggregator

1 Descriptions of Function

All prior work (intellectual property of the company or individual) or proprietary (non-publicly available) work should be so noted.

1.1 Function Name

Distributed Generation Aggregator

1.2 Function ID

IECSA identification number of the function

M-1.2,M-2.2,M-2.3,M-4,G-2,D-1,D-3,L-2.2,L-3,C-5,C-7

1.3 Brief Description

Describe briefly the scope, objectives, and rationale of the Function.

The purpose of the distributed generation aggregator activity is to enable a mechanism whereby a system operator can call on customers during peak periods of energy usage and who have backup generators to disconnect from the power grid and power themselves with their generators.

1.4 Narrative

A complete narrative of the Function from a Domain Expert's point of view, describing what occurs when, why, how, and under what conditions. This will be a separate document, but will act as the basis for identifying the Steps in Section 2.

In areas with high energy costs such as New York City, load curtailment programs have been initiated where facilities can make use of on-site generators that provide back-up power and use them to supply peaking, reserve or load management capability. In many instances, the size of the generators are in the 1 MW or so range and to make economic sense, it is necessary to aggregate multiple units together into one virtual power plant that can be dispatched as would a normal power plant by system aggregators. The system aggregator is responsible for the collection and aggregation of DG units. They generally have a contract to split revenues with the

owners of the DG units. The system aggregator is the point of interface to the system operator. The system aggregator also maintains a control room and responds to calls and inquiries from the system operator before, during and after generation. The system aggregator generally owns and maintains all communication channels to the DG units as well as all of the monitoring equipment used for performance verification. The system aggregator is responsible for calculating settlement and verification with the system operator and distributing payments to the DG unit owners. The DG owners maintain the DG units and usually are responsible for starting and stopping the units.

A typical scenario would be as follows. It is August in NYC and the temperature has hit the high 90s for the third straight day. As the system peak continues to rise, the NYISO forecasts that there could be an energy shortage the following day. In response, the NYISO asks approved system aggregators if they could shed load. In particular, the NYISO asks system aggregator #1 if it could supply 5 MW. The system aggregator then contacts its customers that are under contract if they could run their generators the following day. The system aggregator then totals the amount of expected load that is expected to be relieved from the grid the following day and submits that to the ISO. The system aggregator will try to obtain enough willing customers so that they can reach the 5 MW goal for the day. When the next day arrives, the system aggregator then follows up with each customer to remind them to disconnect from the power grid and to start their generators. The system aggregator and/or system operator monitors over the Internet the output from each generator and totals them to ensure compliance with the 5 MW load. It is important to get near what is asked for maximum revenue can be obtained and to avoid penalties. If a generator fails to start, the system aggregator attempts to get another customer to start their generator. At the end of the day, the generators are stopped and data is collected that is used to verify compliance and to calculate bills that go to the ISO. The system aggregator submits the bills to the ISO and once payment is received, the corresponding revenue is sent to the DG unit owners.

1.5 Actor (Stakeholder) Roles

Describe all the people (their job), systems, databases, organizations, and devices involved in or affected by the Function (e.g. operators, system administrators, technicians, end users, service personnel, executives, SCADA system, real-time database, RTO, RTU, IED, power system). Typically, these actors are logically grouped by organization or functional boundaries or just for collaboration purpose of this use case. We need to identify these groupings and their relevant roles and understand the constituency. The same actor could play different roles in different Functions, but only one role in one Function. If the same actor (e.g. the same person) does play multiple roles in one Function, list these different actor-roles as separate rows.

<i>Grouping (Community)</i>		<i>Group Description</i>
DG aggregation top level		Top level group with all important actors
<i>Actor Name</i>	<i>Actor Type (person, device, system etc.)</i>	<i>Actor Description</i>
SystemAggregator	Person	Entity responsible for the collection, aggregation and dispatch of DG units in response to direction from a system operator
SystemOperator	Organization	Responsible for the operation of the power grid in a particular region. Gives commands to the system aggregators
DEROwner	Person	Owens the DG units used by the system aggregators to supply loads
MonitoringDevice	Device	Collects data to be used for verification and billing purposes
CentralDatabase	System	Takes real-time and collected data from the monitoring equipment and stores in database for later settlement
Communication	Device	Allows for real-time communication between the generators and system aggregators and/or system operators
Controller	Device	In some instances, the control equipment can be used to remotely control the DG units

Replicate this table for each logic group.

1.6 Information exchanged

Describe any information exchanged in this template.

<i>Information Object Name</i>	<i>Information Object Description</i>
Generator Request	Request from system operator to system aggregator for a specific amount of load that can be relieved from the grid
Energy Data	Hourly and current Watt-hours, voltage, current, real and reactive power, etc.
Generator status	Generator status and outputs
Settlement Data	Report submitted to system operator containing settlement and verification information

1.7 Activities/Services

Describe or list the activities and services involved in this Function (in the context of this Function). An activity or service can be provided by a computer system, a set of applications, or manual procedures. These activities/services should be described at an appropriate level, with the understanding that sub-activities and services should be described if they are important for operational issues, automation needs, and implementation reasons. Other sub-activities/services could be left for later analysis.

<i>Activity/Service Name</i>	<i>Activities/Services Provided</i>
Accounting and settlement	System aggregator produces all settlement reports for generation verification that get submitted to the system operator
Real-time monitoring and aggregation page	System aggregator collects real time readings from individual generators and aggregates and displays over web page

1.8 Contracts/Regulations

Identify any overall (human-initiated) contracts, regulations, policies, financial considerations, engineering constraints, pollution constraints, and other environmental quality issues that affect the design and requirements of the Function.

<i>Contract/Regulation</i>	<i>Impact of Contract/Regulation on Function</i>
Contract between system	Contract between system aggregator and DG unit owner committing DG unit owner to provide

<i>Contract/Regulation</i>	<i>Impact of Contract/Regulation on Function</i>
aggregator and DG unit owner	generation when needed by the system operator for a negotiated fee.

<i>Policy</i>	<i>From Actor</i>	<i>May</i>	<i>Shall Not</i>	<i>Shall</i>	<i>Description (verb)</i>	<i>To Actor</i>
Generation	DEROwner			X	Provide use of DG units when required by the system operator	SystemAggregator

<i>Constraint</i>	<i>Type</i>	<i>Description</i>	<i>Applies to</i>
Environmental	Emissions	In general, due to emissions requirements, the DG units can not be run for significant amount of hours in any one year	Overall program

2 Step by Step Analysis of Function

Describe steps that implement the function. If there is more than one set of steps that are relevant, make a copy of the following section grouping (Preconditions and Assumptions, Steps normal sequence, and Steps alternate or exceptional sequence, Post conditions)

2.1 Steps to implement function

Name of this sequence.

2.1.1 Preconditions and Assumptions

Describe conditions that must exist prior to the initiation of the Function, such as prior state of the actors and activities

Identify any assumptions, such as what systems already exist, what contractual relations exist, and what configurations of systems are probably in place

Identify any initial states of information exchanged in the steps in the next section. For example, if a purchase order is exchanged in an activity, its precondition to the activity might be 'filled in but unapproved'.

<i>Actor/System/Information/Contract</i>	<i>Preconditions or Assumptions</i>
SystemOperator	Monitoring the power grid and determining that energy shortage may occur
SystemAggregator	Standing by, waiting for signal from system operator

2.1.2 Steps – Normal Sequence

Describe the normal sequence of events, focusing on steps that identify new types of information or new information exchanges or new interface issues to address. Should the sequence require detailed steps that are also used by other functions, consider creating a new “sub” function, then referring to that “subroutine” in this function. Remember that the focus should be less on the algorithms of the applications and more on the interactions and information flows between “entities”, e.g. people, systems, applications, data bases, etc. There should be a direct link between the narrative and these steps.

The numbering of the sequence steps conveys the order and concurrency and iteration of the steps occur. Using a Dewey Decimal scheme, each level of nested procedure call is separated by a dot ‘.’. Within a level, the sequence number comprises an optional letter and an integer number. The letter specifies a concurrent sequence within the next higher level; all letter sequences are concurrent with other letter sequences. The number specifies the sequencing of messages in a given letter sequence. The absence of a letter is treated as a default ‘main sequence’ in parallel with the lettered sequences.

Sequence 1:

*1.1 - Do step 1
1.2A.1 - In parallel to activity 2 B do step 1
1.2A.2 - In parallel to activity 2 B do step 2
1.2B.1 - In parallel to activity 2 A do step 1
1.2B.2 - In parallel to activity 2 A do step 2
1.3 - Do step 3
1.3.1 - nested step 3.1
1.3.2 - nested step 3.2*

Sequence 2:

*2.1 - Do step 1
2.2 - Do step 2*

#	Event	Primary Actor	Name of Process/Activity	Description of Process/Activity	Information Producer	Information Receiver	Name of Info Exchanged	Additional Notes	IECSA Environments
#	<i>Triggering event? Identify the name of the event.¹</i>	<i>What other actors are primarily responsible for the Process/Activity? Actors are defined in section 1.5.</i>	<i>Label that would appear in a process diagram. Use action verbs when naming activity.</i>	<i>Describe the actions that take place in active and present tense. The step should be a descriptive noun/verb phrase that portrays an outline summary of the step. "If ...Then...Else" scenarios can be captured as multiple Actions or as separate steps.</i>	<i>What other actors are primarily responsible for Producing the information? Actors are defined in section 1.5.</i>	<i>What other actors are primarily responsible for Receiving the information? Actors are defined in section 1.5. (Note – May leave blank if same as Primary Actor)</i>	<i>Name of the information object. Information objects are defined in section 1.6</i>	<i>Elaborate architectural issues using attached spreadsheet. Use this column to elaborate details that aren't captured in the spreadsheet.</i>	<i>Reference the applicable IECSA Environment containing this data exchange. Only one environment per step.</i>
1.1	System Operator Initiates Curtailment	System Operator	System Aggregator Notification	During a heat wave, the system operator forecasts that a possible energy shortage may exist the following day and therefore contacts approved System Aggregators and asks them if they can provide a set number of MWs the following day	System Operator	System Aggregator	Generation Requests		Control Centers / ESPs

¹ Note – A triggering event is not necessary if the completion of the prior step – leads to the transition of the following step.

#	Event	Primary Actor	Name of Process/Activity	Description of Process/Activity	Information Producer	Information Receiver	Name of Info Exchanged	Additional Notes	IECSA Environments
1.2	SystemAggregator Polls DG Unit Owners	SystemAggregator	DG Unit Owner Pre-Notification	SystemAggregator contacts individual customers requesting that they separate from the grid and run off their generators	SystemAggregator	DEROwner	Generation Requests		DER Monitoring and Control
1.3	Generation Start Time	SystemAggregator	DG Unit Owner On Notification	SystemAggregator contacts customers at the start time to make sure customer complies with request	SystemAggregator	DEROwner	Generator Status		DER Monitoring and Control
1.4	Monitoring	SystemAggregator	DG Unit Monitoring	SystemAggregator monitors in real-time the generator output to verify goal is being met	MonitoringDevice	CentralDatabase	Energy Data	Key communication requirements in this step	DER Monitoring and Control
1.5	Generation End Time	SystemAggregator	DG Unit Owner Off Notification	SystemAggregator contacts customers at the end time to make sure customer shuts down generators	SystemAggregator	DEROwner	Generator Status		DER Monitoring and Control

#	Event	Primary Actor	Name of Process/Activity	Description of Process/Activity	Information Producer	Information Receiver	Name of Info Exchanged	Additional Notes	IECSA Environments
1.6	Settlement	SystemAggregator	Settlement	SystemAggregator generates settlement reports from the data and submits to the system operator	CentralDatabase	SystemOperator	Settlement Data		Control Centers / ESPs

2.1.3 Steps – Alternative / Exception Sequences

Describe any alternative or exception sequences that may be required that deviate from the normal course of activities. Note instructions are found in previous table.

#	Event	Primary Actor	Name of Process/Activity	Description of Process/Activity	Information Producer	Information Receiver	Name of Info Exchanged	Additional Notes	IECSA Environments

2.1.4 Post-conditions and Significant Results

Describe conditions that must exist at the conclusion of the Function. Identify significant items similar to that in the preconditions section.

Describe any significant results from the Function

<i>Actor/Activity</i>	<i>Post-conditions Description and Results</i>
DG Units	Ready to go again in case needed

2.2 Architectural Issues in Interactions

Elaborate on all architectural issues in each of the steps outlined in each of the sequences above. Reference the Step by number..



Microsoft Excel
Worksheet

2.3 Diagram

For clarification, draw (by hand, by Power Point, by UML diagram) the interactions, identifying the Steps where possible.

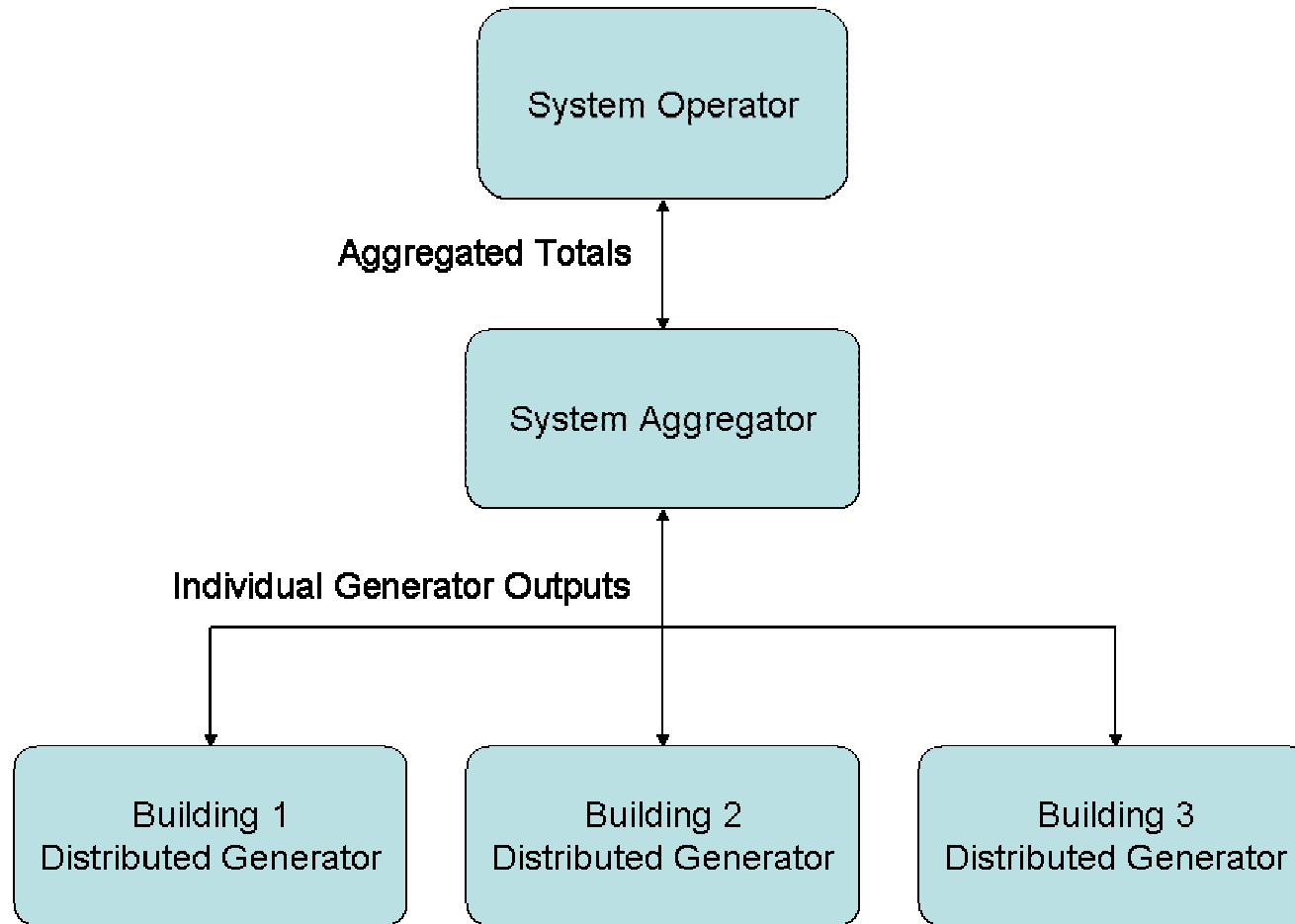

3 Auxiliary Issues

3.1 References and contacts

Documents and individuals or organizations used as background to the function described; other functions referenced by this function, or acting as “sub” functions; or other documentation that clarifies the requirements or activities described. All prior work (intellectual property of the company or individual) or proprietary (non-publicly available) work must be so noted.

ID	Title or contact	Reference or contact information
[1]		
[2]		

3.2 Action Item List

As the function is developed, identify issues that still need clarification, resolution, or other notice taken of them. This can act as an Action Item list.

ID	Description	Status
[1]		
[2]		

3.3 Revision History

For reference and tracking purposes, indicate who worked on describing this function, and what aspect they undertook.

No	Date	Author	Description
0.			

No	Date	Author	Description

Permanent Power Quality Measurement

1 Descriptions of Function

All prior work (intellectual property of the company or individual) or proprietary (non-publicly available) work should be so noted.

1.1 Function Name

Permanent Power Quality Measurement

1.2 Function ID

IECSA identification number of the function

G-3.8.1,G-3.8.2,D-11,C-9.4,C-9,C-9.1,C-9.5

1.3 Brief Description

Describe briefly the scope, objectives, and rationale of the Function.

The purpose of the permanent power quality measurement enterprise activity is to provide long-term and continuous monitoring in order to provide reliability and benchmarking statistics.

1.4 Narrative

A complete narrative of the Function from a Domain Expert's point of view, describing what occurs when, why, how, and under what conditions. This will be a separate document, but will act as the basis for identifying the Steps in Section 2.

Many customers which can include utilities and large consumers of electric power have a need for an installed permanent power quality measurement system. Historically, power quality meters were portable and installed on a temporary basis in order to capture, diagnose and solve a specific problem that might be occurring in the facility. However, with increased demands for power quality and reliability benchmarking, power quality contracts, billing and energy use verification, predictive maintenance and others, the need and demand for permanent power quality monitoring has increased dramatically in recent years.

The following is a typical scenario. An electric utility realizes the need for a permanently installed power quality measurement system. The reason could be new standards from the state PUC or competitive threats or even just to keep existing customers happy. In addition, the utility could be implementing power quality contracts and needs a mechanism to verify performance. A utility will then generally procure and install monitors at various locations. The locations could be statistically selected or just placed at key customer locations. Once the instruments are installed, it will be necessary to establish communication from a central location to the instruments. At the central server location, there will generally be two types of applications. The first is the downloading application that uses the communication medium selected and is used to setup and download the data from the instruments in the field. This requires communication from the central server location to the monitoring instrument either by telephone, Internet, satellite or other. Typically this is done on a daily basis or after a significant event occurs. The instrument captures and stores event data in standard or proprietary form inside instrument. Optional gateway device downloads event data from instrument, converts it to a standardized format (IEEE 1159.3 PQDIF), and stores until downloaded by enterprise system. Enterprise system downloads data from the instrument or gateway, converts to standard format if necessary, and puts in standardized file hierarchy (IEEE 1159.3 PQDIF Annex C) and/or a commercial power quality database (e.g. PQView). The second application resides on the central server and is usually a database application that is used to characterize, store and report results from the data collection. The central server also typically acts as a web server and is used to supply data over corporate intranets or the internet itself.

1.5 Actor (Stakeholder) Roles

Describe all the people (their job), systems, databases, organizations, and devices involved in or affected by the Function (e.g. operators, system administrators, technicians, end users, service personnel, executives, SCADA system, real-time database, RTO, RTU, IED, power system). Typically, these actors are logically grouped by organization or functional boundaries or just for collaboration purpose of this use case. We need to identify these groupings and their relevant roles and understand the constituency. The same actor could play different roles in different Functions, but only one role in one Function. If the same actor (e.g. the same person) does play multiple roles in one Function, list these different actor-roles as separate rows.

<i>Grouping (Community)</i>		<i>Group Description</i>
Permanent power quality measurement top level		Top level group with all important actors
<i>Actor Name</i>	<i>Actor Type (person, device, system etc.)</i>	<i>Actor Description</i>
Central	System	Downloads instruments located in the field, accepts incoming calls from

<i>Grouping (Community)</i>		<i>Group Description</i>
Permanent power quality measurement top level		Top level group with all important actors
<i>Actor Name</i>	<i>Actor Type (person, device, system etc.)</i>	<i>Actor Description</i>
Server		instruments, creates database of event and steady-state data, generates reports and summary graphs and tables
PowerQuality Instrument	Device	Captures and records power quality events and sends to central server
Database and Software Provider	Software	Provides download, archiving and reporting software
Communication	Device and System	Mechanism for power quality instrument to contact or be contacted by the central server
Customer	Person	Group interested in data collected from instruments, could be utility and/or end-use customers

Replicate this table for each logic group.

1.6 Information exchanged

Describe any information exchanged in this template.

<i>Information Object Name</i>	<i>Information Object Description</i>
Site selection	Place where monitor is to be installed

<i>Information Object Name</i>	<i>Information Object Description</i>
Site selection	Place where monitor is to be installed
Raw Power quality event data	Events and performance monitoring results captured by power quality instruments
Data summaries, graphs and tables	Post processed raw data summarized and presented in reports and graphs

1.7 Activities/Services

Describe or list the activities and services involved in this Function (in the context of this Function). An activity or service can be provided by a computer system, a set of applications, or manual procedures. These activities/services should be described at an appropriate level, with the understanding that sub-activities and services should be described if they are important for operational issues, automation needs, and implementation reasons. Other sub-activities/services could be left for later analysis.

<i>Activity/Service Name</i>	<i>Activities/Services Provided</i>
Event capture	Instruments in the field must capture events when they occur
Data download	Periodically, the central server must download the data from the instruments in the field
Characterization and Storage	After download, the data is characterized and stored in a central database
Reporting	Periodically, various reports are generated summarizing the data collected

1.8 Contracts/Regulations

Identify any overall (human-initiated) contracts, regulations, policies, financial considerations, engineering constraints, pollution constraints, and other environmental quality issues that affect the design and requirements of the Function.

<i>Contract/Regulation</i>	<i>Impact of Contract/Regulation on Function</i>

<i>Policy</i>	<i>From Actor</i>	<i>May</i>	<i>Shall Not</i>	<i>Shall</i>	<i>Description (verb)</i>	<i>To Actor</i>

<i>Constraint</i>	<i>Type</i>	<i>Description</i>	<i>Applies to</i>

2 Step by Step Analysis of Function

Describe steps that implement the function. If there is more than one set of steps that are relevant, make a copy of the following section grouping (Preconditions and Assumptions, Steps normal sequence, and Steps alternate or exceptional sequence, Post conditions)

2.1 Steps to implement function

Name of this sequence.

2.1.1 Preconditions and Assumptions

Describe conditions that must exist prior to the initiation of the Function, such as prior state of the actors and activities

Identify any assumptions, such as what systems already exist, what contractual relations exist, and what configurations of systems are probably in place

Identify any initial states of information exchanged in the steps in the next section. For example, if a purchase order is exchanged in an activity, its precondition to the activity might be 'filled in but unapproved'.

<i>Actor/System/Information/Contract</i>	<i>Preconditions or Assumptions</i>
Power quality instrument	Instruments installed and ready to capture, communication system functioning properly

2.1.2 Steps – Normal Sequence

Describe the normal sequence of events, focusing on steps that identify new types of information or new information exchanges or new interface issues to address. Should the sequence require detailed steps that are also used by other functions, consider creating a new “sub” function, then referring to that “subroutine” in this function. Remember that the focus should be less on the algorithms of the applications and more on the interactions and information flows between “entities”, e.g. people, systems, applications, data bases, etc. There should be a direct link between the narrative and these steps.

The numbering of the sequence steps conveys the order and concurrency and iteration of the steps occur. Using a Dewey Decimal scheme, each level of nested procedure call is separated by a dot ‘.’. Within a level, the sequence number comprises an optional letter and an integer number. The letter specifies a concurrent sequence within the next higher level; all letter sequences are concurrent with other letter sequences. The number specifies the sequencing of messages in a given letter sequence. The absence of a letter is treated as a default ‘main sequence’ in parallel with the lettered sequences.

Sequence 1:

*1.1 - Do step 1
1.2A.1 - In parallel to activity 2 B do step 1
1.2A.2 - In parallel to activity 2 B do step 2
1.2B.1 - In parallel to activity 2 A do step 1
1.2B.2 - In parallel to activity 2 A do step 2
1.3 - Do step 3
1.3.1 - nested step 3.1
1.3.2 - nested step 3.2*

Sequence 2:

*2.1 - Do step 1
2.2 - Do step 2*

#	Event	Primary Actor	Name of Process/Activity	Description of Process/Activity	Information Producer	Information Receiver	Name of Info Exchanged	Additional Notes	IECSA Environments
#	<i>Triggering event? Identify the name of the event.¹</i>	<i>What other actors are primarily responsible for the Process/Activity? Actors are defined in section 1.5.</i>	<i>Label that would appear in a process diagram. Use action verbs when naming activity.</i>	<i>Describe the actions that take place in active and present tense. The step should be a descriptive noun/verb phrase that portrays an outline summary of the step. "If ...Then...Else" scenarios can be captured as multiple Actions or as separate steps.</i>	<i>What other actors are primarily responsible for Producing the information? Actors are defined in section 1.5.</i>	<i>What other actors are primarily responsible for Receiving the information? Actors are defined in section 1.5. (Note – May leave blank if same as Primary Actor)</i>	<i>Name of the information object. Information objects are defined in section 1.6</i>	<i>Elaborate architectural issues using attached spreadsheet. Use this column to elaborate details that aren't captured in the spreadsheet.</i>	<i>Reference the applicable IECSA Environment containing this data exchange. Only one environment per step.</i>
1.1	Site Selection and Installation	Customer	Site Selection and Installation	Customer selects sites for permanently installed power quality monitors and installs them	Customer	Customer	Site Selection		Intra-Customer Site
1.2	Event Capture	PowerQualityInstrument	Event Capture	If thresholds are exceeded the power quality instrument captures and records and event	PowerQuality Instrument	PowerQualityInstrument	Raw power quality event data		NA

¹ Note – A triggering event is not necessary if the completion of the prior step – leads to the transition of the following step.

#	Event	Primary Actor	Name of Process/Activity	Description of Process/Activity	Information Producer	Information Receiver	Name of Info Exchanged	Additional Notes	IECSA Environments
1.3	Event Transmittal	Database and Software Provider	Event Transmittal	If an event is triggered, the instrument calls back to the central server and the server downloads the data	PowerQuality Instrument	Central Server	Raw power quality event data	Basic telecommunication constraints such as modem and dial up telephone connection, but could also include internet TCP/IP connectivity or even cellular	Customer / ESP
1.4	Data Storage, Characterization and Reporting	Database and Software Provider	Data Storage and Characterization	Based on events recorded, data is characterized and loaded into a database and reports are generated	Central Server	Customer	Data report that includes a sag score	Data management in terms of culling important information	Customer / ESP

2.1.3 Steps – Alternative / Exception Sequences

Describe any alternative or exception sequences that may be required that deviate from the normal course of activities. Note instructions are found in previous table.

#	Event	Primary Actor	Name of Process/Activity	Description of Process/Activity	Information Producer	Information Receiver	Name of Info Exchanged	Additional Notes	IECSA Environments

2.1.4 Post-conditions and Significant Results

Describe conditions that must exist at the conclusion of the Function. Identify significant items similar to that in the preconditions section.

Describe any significant results from the Function

<i>Actor/Activity</i>	<i>Post-conditions Description and Results</i>
Power quality instrument	Instruments installed and ready to capture, communication system functioning properly

2.2 Architectural Issues in Interactions

Elaborate on all architectural issues in each of the steps outlined in each of the sequences above. Reference the Step by number..



Microsoft Excel
Worksheet

2.3 Diagram

For clarification, draw (by hand, by Power Point, by UML diagram) the interactions, identifying the Steps where possible.

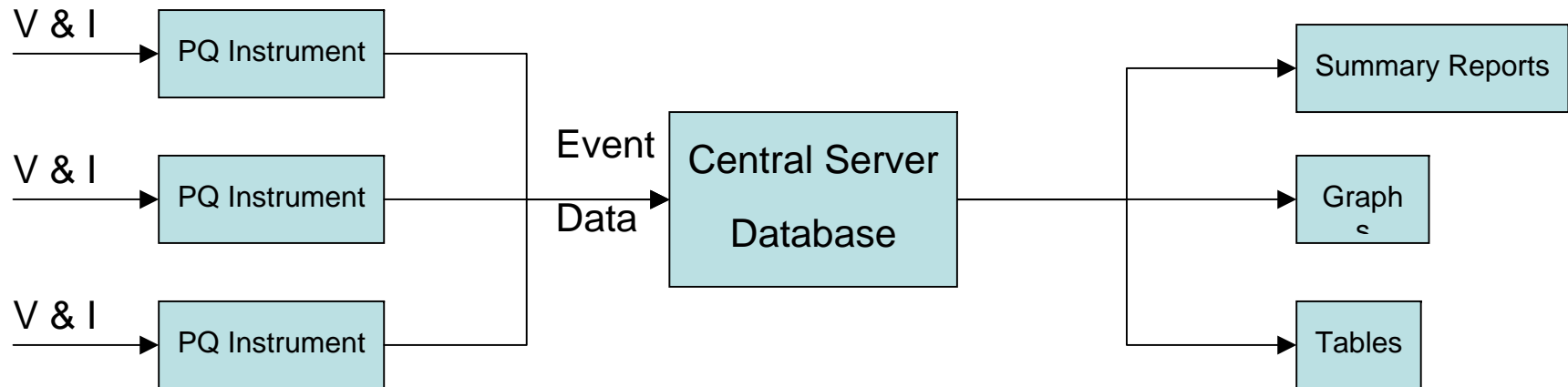

3 Auxiliary Issues

3.1 References and contacts

Documents and individuals or organizations used as background to the function described; other functions referenced by this function, or acting as “sub” functions; or other documentation that clarifies the requirements or activities described. All prior work (intellectual property of the company or individual) or proprietary (non-publicly available) work must be so noted.

ID	Title or contact	Reference or contact information
[1]		
[2]		

3.2 Action Item List

As the function is developed, identify issues that still need clarification, resolution, or other notice taken of them. This can act as an Action Item list.

ID	Description	Status
[1]		
[2]		

3.3 Revision History

For reference and tracking purposes, indicate who worked on describing this function, and what aspect they undertook.

No	Date	Author	Description
0.			

Power Quality Contracts

1 Descriptions of Function

All prior work (intellectual property of the company or individual) or proprietary (non-publicly available) work should be so noted.

1.1 Function Name

Power Quality Contracts

1.2 Function ID

IECSA identification number of the function

M-1.1,M-1.2,D-11,C-9,C-9.1,C-9.2,C-9.4,C-9.5

1.3 Brief Description

Describe briefly the scope, objectives, and rationale of the Function.

The purpose of the power quality contracts enterprise activity is to enable a mechanism whereby energy service providers could lock in long term contracts with large industrial customers by providing service guarantees based on the quality of electric power supplied over a period of time. In return for signing a long term contract, the customer receives favorable long term rates as well as power quality performance guarantees from the energy service provider. This assures the industrial customer that the energy service provider will be responsive to their problems over the duration of the contract.

1.4 Narrative

A complete narrative of the Function from a Domain Expert's point of view, describing what occurs when, why, how, and under what conditions. This will be a separate document, but will act as the basis for identifying the Steps in Section 2.

Industrial customers are facing increasing energy costs and increasing competition. Energy service providers are facing increasing competitive threats from other ESPs in a deregulated environment. In order for industrial customers to lock in long term favorable rates

and in order for ESPs to prevent customers from going elsewhere to obtain electric power, the concept of the power quality contract has emerged. In return for signing a long term contract whereby the industrial customer agrees to not seek power from other providers, the EnergyServiceProvider must guarantee a certain level of power quality and reliability. If the level of power quality and reliability is worse than an agreed upon level, the EnergyServiceProvider would owe penalty payments to the industrial customer. Therefore, the incentive exists for the EnergyServiceProvider to keep upgrading and improving the performance of the system.

In order to do this, the EnergyServiceProvider must install electric power monitoring instrumentation at the service entrance of each customer. In general these contracts would apply to large transmission customers where outages are rare, so the primary concern is the number and severity of voltage sags caused by faults on the system. These instruments generally must be able to capture RMS variations, call back to a central server when an event occurs, and be able to capture enough data such as current to be able to ascertain whether the event was caused by something on the EnergyServiceProvider system or inside the customer facility. This requires communication from the central server location to the monitoring instrument either by telephone, Internet, satellite or other.

In general, a database is maintained at the central server so that event analysis can be conducted as well as the calculation of a score or index for a particular customer or site. A base level is required and is generally done before the contract term is started. The baseline or target is continually updated usually on a yearly basis and is in effect a rolling average. A score is given for each event and then totaled on a yearly basis. If the score is above the target number, then payments are made to the customer based on previously agreed upon formula.

1.5 Actor (Stakeholder) Roles

Describe all the people (their job), systems, databases, organizations, and devices involved in or affected by the Function (e.g. operators, system administrators, technicians, end users, service personnel, executives, SCADA system, real-time database, RTO, RTU, IED, power system). Typically, these actors are logically grouped by organization or functional boundaries or just for collaboration purpose of this use case. We need to identify these groupings and their relevant roles and understand the constituency. The same actor could play different roles in different Functions, but only one role in one Function. If the same actor (e.g. the same person) does play multiple roles in one Function, list these different actor-roles as separate rows.

<i>Grouping (Community)</i>		<i>Group Description</i>
Energy Service Provider (EnergyServiceProvider)		Provides the electric power
<i>Actor Name</i>	<i>Actor Type (person, device, system etc.)</i>	<i>Actor Description</i>
Central Server	System	Downloads instruments located at service entrance of industrial customers under contract, accepts incoming calls from instruments, creates database of sag scores and calculates penalty payments
Contract administrator	Person	Person responsible for writing and administering the power quality contract
EnergyServiceProvider		

<i>Grouping (Community)</i>		<i>Group Description</i>
Hardware and Software Vendors		Provide instruments and software to enforce contracts
<i>Actor Name</i>	<i>Actor Type (person, device, system etc.)</i>	<i>Actor Description</i>
PowerQuality Instrument	Device	Captures and records power quality events and sends to central server
Database and SoftwareProvider	Software	Provides download, archiving and reporting software

<i>Grouping (Community)'</i>		<i>Group Description</i>
Hardware and Software Vendors		Provide instruments and software to enforce contracts
<i>Actor Name</i>	<i>Actor Type (person, device, system etc.)</i>	<i>Actor Description</i>
Communication	Device and System	Mechanism for power quality instrument to contact or be contacted by the central server

<i>Grouping (Community)'</i>		<i>Group Description</i>
Customers		Consumes electric power
<i>Actor Name</i>	<i>Actor Type (person, device, system etc.)</i>	<i>Actor Description</i>
FacilityManager	Person	Responsible for supplying reliable electric power in customer facility
Customer		

Replicate this table for each logic group.

1.6 Information exchanged

Describe any information exchanged in this template.

<i>Information Object Name</i>	<i>Information Object Description</i>
Raw Power quality event data	Events and performance monitoring results captured by power quality instruments

<i>Information Object Name</i>	<i>Information Object Description</i>
Aggregated performance summaries	Post processed raw data summarized and compared to baseline data for the purpose of calculating penalty payments

1.7 Activities/Services

Describe or list the activities and services involved in this Function (in the context of this Function). An activity or service can be provided by a computer system, a set of applications, or manual procedures. These activities/services should be described at an appropriate level, with the understanding that sub-activities and services should be described if they are important for operational issues, automation needs, and implementation reasons. Other sub-activities/services could be left for later analysis.

<i>Activity/Service Name</i>	<i>Activities/Services Provided</i>
Event capture	Instruments in the field must capture events when they occur
Data download	Periodically, the central server must download the data from the instruments in the field
Account reconciliation	Periodically, the database employed must generate summary reports and calculate penalty payments
Baselining	Periodically, the minimum level at which penalties are applied needs to be calculated

1.8 Contracts/Regulations

Identify any overall (human-initiated) contracts, regulations, policies, financial considerations, engineering constraints, pollution constraints, and other environmental quality issues that affect the design and requirements of the Function.

<i>Contract/Regulation</i>	<i>Impact of Contract/Regulation on Function</i>
PQ Contract	Terms dictate amount and frequency of penalties and also how the baseline is calculated, refined and set

<i>Policy</i>	<i>From Actor</i>	<i>May</i>	<i>Shall Not</i>	<i>Shall</i>	<i>Description (verb)</i>	<i>To Actor</i>
Customer Service	EnergyServiceProvider			X	Provide guaranteed levels of power quality and adequate customer service	Customer
Customer Lock In	Customer		X		Seed power from other sources while under contract	EnergyServicePr ovider

<i>Constraint</i>	<i>Type</i>	<i>Description</i>	<i>Applies to</i>
Instrument	Data	PQ contract is contingent on the accuracy and reliability of data captured by monitoring instruments	Overall program

2 Step by Step Analysis of Function

Describe steps that implement the function. If there is more than one set of steps that are relevant, make a copy of the following section grouping (Preconditions and Assumptions, Steps normal sequence, and Steps alternate or exceptional sequence, Post conditions)

2.1 Steps to implement function

Name of this sequence.

2.1.1 Preconditions and Assumptions

Describe conditions that must exist prior to the initiation of the Function, such as prior state of the actors and activities

Identify any assumptions, such as what systems already exist, what contractual relations exist, and what configurations of systems are probably in place

Identify any initial states of information exchanged in the steps in the next section. For example, if a purchase order is exchanged in an activity, its precondition to the activity might be 'filled in but unapproved'.

<i>Actor/System/Information/Contract</i>	<i>Preconditions or Assumptions</i>
EnergyServiceProvider	Must have adequate monitoring instruments pre-installed over a period of time in order to set up a baseline for calculation of penalty payments

2.1.2 Steps – Normal Sequence

Describe the normal sequence of events, focusing on steps that identify new types of information or new information exchanges or new interface issues to address. Should the sequence require detailed steps that are also used by other functions, consider creating a new “sub” function, then referring to that “subroutine” in this function. Remember that the focus should be less on the algorithms of the applications and more on the interactions and information flows between “entities”, e.g. people, systems, applications, data bases, etc. There should be a direct link between the narrative and these steps.

The numbering of the sequence steps conveys the order and concurrency and iteration of the steps occur. Using a Dewey Decimal scheme, each level of nested procedure call is separated by a dot ‘.’. Within a level, the sequence number comprises an optional letter and an integer number. The letter specifies a concurrent sequence within the next higher level; all letter sequences are concurrent with other letter sequences. The number specifies the sequencing of messages in a given letter sequence. The absence of a letter is treated as a default ‘main sequence’ in parallel with the lettered sequences.

Sequence 1:

*1.1 - Do step 1
1.2A.1 - In parallel to activity 2 B do step 1
1.2A.2 - In parallel to activity 2 B do step 2
1.2B.1 - In parallel to activity 2 A do step 1
1.2B.2 - In parallel to activity 2 A do step 2
1.3 - Do step 3
1.3.1 - nested step 3.1
1.3.2 - nested step 3.2*

Sequence 2:

*2.1 - Do step 1
2.2 - Do step 2*

#	Event	Primary Actor	Name of Process/Activity	Description of Process/Activity	Information Producer	Information Receiver	Name of Info Exchanged	Additional Notes	IECSA Environments
#	<i>Triggering event? Identify the name of the event.¹</i>	<i>What other actors are primarily responsible for the Process/Activity? Actors are defined in section 1.5.</i>	<i>Label that would appear in a process diagram. Use action verbs when naming activity.</i>	<i>Describe the actions that take place in active and present tense. The step should be a descriptive noun/verb phrase that portrays an outline summary of the step. "If ...Then...Else" scenarios can be captured as multiple Actions or as separate steps.</i>	<i>What other actors are primarily responsible for Producing the information? Actors are defined in section 1.5.</i>	<i>What other actors are primarily responsible for Receiving the information? Actors are defined in section 1.5. (Note – May leave blank if same as Primary Actor)</i>	<i>Name of the information object. Information objects are defined in section 1.6</i>	<i>Elaborate architectural issues using attached spreadsheet. Use this column to elaborate details that aren't captured in the spreadsheet.</i>	<i>Reference the applicable IECSA Environment containing this data exchange. Only one environment per step.</i>
1.1	Event Capture and Transmittal	Instrument	Event Capture and Transmittal	If an event is triggered, the instrument calls back to the central server and the server downloads the data	PowerQuality Instrument	Central Server	Voltage and current waveforms and data	Basic telecommunication constraints such as modem and dial up telephone connection, but could also include internet TCP/IP connectivity or even cellular	Customer / ESP

¹ Note – A triggering event is not necessary if the completion of the prior step – leads to the transition of the following step.

#	Event	Primary Actor	Name of Process/Activity	Description of Process/Activity	Information Producer	Information Receiver	Name of Info Exchanged	Additional Notes	IECSA Environments
1.2	Sag Score Calculated	Central server database software	Sag Score Calculated	Based on events recorded, data is characterized and loaded into a database, then a sag score is calculated based on previously agreed algorithm	Central Server	Customer	Data report that includes a sag score	Data management in terms of culling important information	Customer / ESP
1.3	Penalty calculation	Central server database software		Based on the previously agreed upon baseline or rolling average, the previous sag score is compared to the baseline and a penalty is then calculated	Central Server	Customer	Report that summarizes penalty payments	None	Customer / ESP

2.1.3 Steps – Alternative / Exception Sequences

Describe any alternative or exception sequences that may be required that deviate from the normal course of activities. Note instructions are found in previous table.

#	Event	Primary Actor	Name of Process/Activity	Description of Process/Activity	Information Producer	Information Receiver	Name of Info Exchanged	Additional Notes	IECSA Environments

2.1.4 Post-conditions and Significant Results

Describe conditions that must exist at the conclusion of the Function. Identify significant items similar to that in the preconditions section.

Describe any significant results from the Function

<i>Actor/Activity</i>	<i>Post-conditions Description and Results</i>
EnergyServiceProvider	Must be able to create sag score and penalty calculation from data collected as well as updating the baseline on a period basis

2.2 Architectural Issues in Interactions

Elaborate on all architectural issues in each of the steps outlined in each of the sequences above. Reference the Step by number..



Microsoft Excel
Worksheet

2.3 Diagram

For clarification, draw (by hand, by Power Point, by UML diagram) the interactions, identifying the Steps where possible.

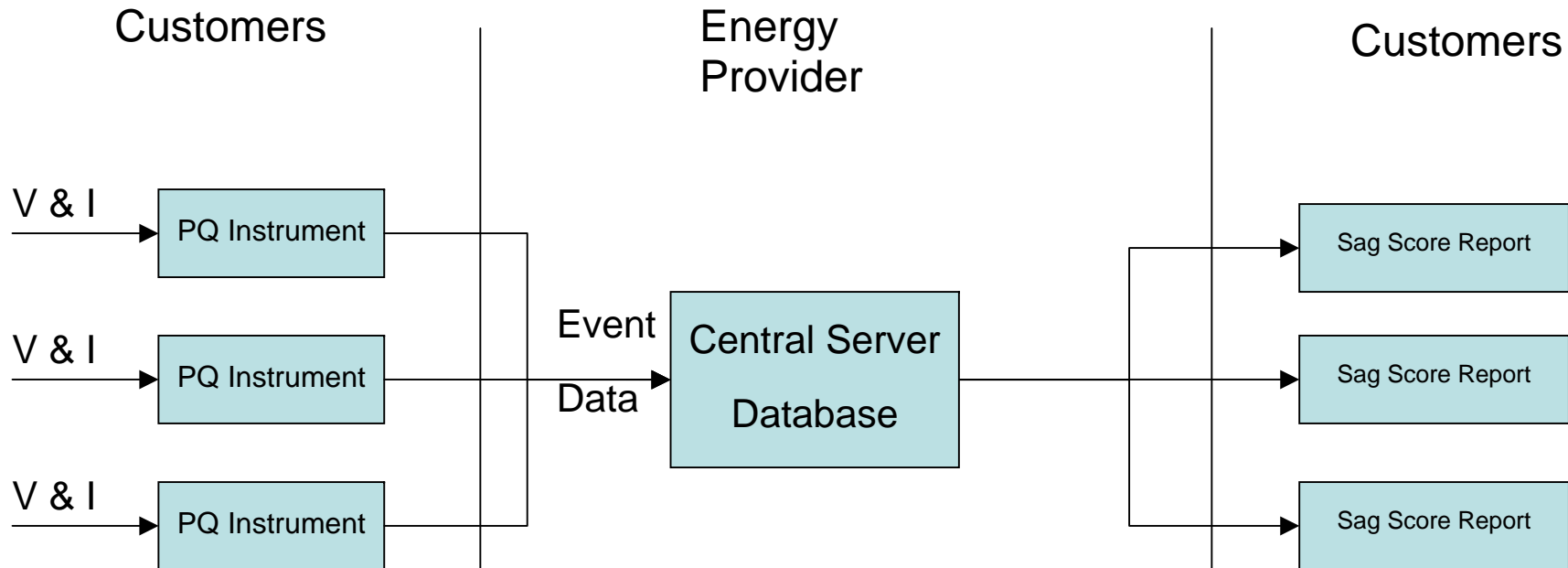

3 Auxiliary Issues

3.1 References and contacts

Documents and individuals or organizations used as background to the function described; other functions referenced by this function, or acting as “sub” functions; or other documentation that clarifies the requirements or activities described. All prior work (intellectual property of the company or individual) or proprietary (non-publicly available) work must be so noted.

ID	Title or contact	Reference or contact information
[1]	Andy Detloff Papers	Detroit Edison
[2]		

3.2 Action Item List

As the function is developed, identify issues that still need clarification, resolution, or other notice taken of them. This can act as an Action Item list.

ID	Description	Status
[1]		
[2]		

3.3 Revision History

For reference and tracking purposes, indicate who worked on describing this function, and what aspect they undertook.

No	Date	Author	Description
0.			

This page intentionally left blank.

Power Quality Event Notifications

1 Descriptions of Function

All prior work (intellectual property of the company or individual) or proprietary (non-publicly available) work should be so noted.

1.1 Function Name

Power Quality Event Notifications

1.2 Function ID

IECSA identification number of the function

D-11,C-9.1,C-9

1.3 Brief Description

Describe briefly the scope, objectives, and rationale of the Function.

The purpose of the power quality event notifications enterprise activity is to enable a mechanism whereby stakeholders are alerted as soon as possible to the location, time and severity of power quality events that occur.

1.4 Narrative

A complete narrative of the Function from a Domain Expert's point of view, describing what occurs when, why, how, and under what conditions. This will be a separate document, but will act as the basis for identifying the Steps in Section 2.

Power quality event capture instruments can be installed anywhere on the electric power grid including transmission substations all the way down to end-use customer facilities. After an event capture there are generally two methods employed to notify stakeholders that an event has occurred. The first method is an “on-the-fly” approach, near real-time. When an event is captured, if it exceeds pre-set thresholds for notifications, then an email or page is immediately sent to a list of recipients. Generally, these emails or pages will list

the time, magnitude and severity. In the case of some instrument manufacturers, a link is given to go back and view the event and in some cases, the event is embedded in the actual email message.

The other form of event notification is “after-the-fact” or post-processed. In this method, the data is collected and then processed by a central server or other type of application that is looking for events that exceeded thresholds. In this case, the central server application then sends out emails or pages to a list of recipients. This method has time lag built in because in some instances, data is downloaded only daily and messages are sent after the data is post-processed. Some instruments after an event is captured, will call back to the central server to let the server know, they should download data, reducing the time lag.

Key communication occurs between the instruments to pager vendor and ISPs and from the instruments to the central server and then similarly from the central server out to pager vendor and ISPs or internal mail servers.

1.5 Actor (Stakeholder) Roles

Describe all the people (their job), systems, databases, organizations, and devices involved in or affected by the Function (e.g. operators, system administrators, technicians, end users, service personnel, executives, SCADA system, real-time database, RTO, RTU, IED, power system). Typically, these actors are logically grouped by organization or functional boundaries or just for collaboration purpose of this use case. We need to identify these groupings and their relevant roles and understand the constituency. The same actor could play different roles in different Functions, but only one role in one Function. If the same actor (e.g. the same person) does play multiple roles in one Function, list these different actor-roles as separate rows.

<i>Grouping (Community)</i>		<i>Group Description</i>
Hardware and Software Vendors		Provide instruments and software to capture events and provide notifications to stakeholders
<i>Actor Name</i>	<i>Actor Type (person, device, system etc.)</i>	<i>Actor Description</i>
PowerQuality Instrument	Device	Captures and records power quality events and sends event information to central server or stakeholders directly

<i>Grouping (Community)</i>		<i>Group Description</i>
Hardware and Software Vendors		Provide instruments and software to capture events and provide notifications to stakeholders
<i>Actor Name</i>	<i>Actor Type (person, device, system etc.)</i>	<i>Actor Description</i>
Database and Software Provider	Software	Provides download, archiving and notification software
Central Server	System	Downloads instruments located at variety of locations, accepts incoming calls from instruments, sends out notifications through pager vendors and/or ISPs or internal mail servers
Communication	Device and System	Mechanism for power quality instrument to contact or be contacted by the central server or to contact pager vendor and ISPs directly
Instrument		
Instrument manufacturer		

<i>Grouping (Community)</i>		<i>Group Description</i>
Customers		Key stakeholders that need data
<i>Actor Name</i>	<i>Actor Type (person, device, system etc.)</i>	<i>Actor Description</i>
Customer	Person	Stakeholders that need PQ event data notifications as quickly as possible

Replicate this table for each logic group.

1.6 Information exchanged

Describe any information exchanged in this template.

<i>Information Object Name</i>	<i>Information Object Description</i>
Power quality event data	Events including magnitude and duration and other parameters captured by power quality instruments

1.7 Activities/Services

Describe or list the activities and services involved in this Function (in the context of this Function). An activity or service can be provided by a computer system, a set of applications, or manual procedures. These activities/services should be described at an appropriate level, with the understanding that sub-activities and services should be described if they are important for operational issues, automation needs, and implementation reasons. Other sub-activities/services could be left for later analysis.

<i>Activity/Service Name</i>	<i>Activities/Services Provided</i>
Event capture and notification	Instruments in the field must capture events when they occur and send out notifications via pager or email as soon as they occur
Data download	Periodically, the central server must download the data from the instruments in the field
Post Process notification	After downloading and processing data, central server sends out notifications via pager or email as soon as possible

1.8 Contracts/Regulations

Identify any overall (human-initiated) contracts, regulations, policies, financial considerations, engineering constraints, pollution constraints, and other environmental quality issues that affect the design and requirements of the Function.

<i>Contract/Regulation</i>	<i>Impact of Contract/Regulation on Function</i>
Speed of Notification	Terms dictate how quickly from an event capture that notifications are required to be sent

<i>Policy</i>	<i>From Actor</i>	<i>May</i>	<i>Shall Not</i>	<i>Shall</i>	<i>Description (verb)</i>	<i>To Actor</i>
Notification speed	Instrument manufacturer			X	Provide specifications on time between event capture and event notification to customer	Customer

<i>Constraint</i>	<i>Type</i>	<i>Description</i>	<i>Applies to</i>
Instrument	Data	Notifications are contingent on the accuracy and reliability of data captured by monitoring instruments	Overall program

2 Step by Step Analysis of Function

Describe steps that implement the function. If there is more than one set of steps that are relevant, make a copy of the following section grouping (Preconditions and Assumptions, Steps normal sequence, and Steps alternate or exceptional sequence, Post conditions)

2.1 Steps to implement function

Name of this sequence.

2.1.1 Preconditions and Assumptions

Describe conditions that must exist prior to the initiation of the Function, such as prior state of the actors and activities

Identify any assumptions, such as what systems already exist, what contractual relations exist, and what configurations of systems are probably in place

Identify any initial states of information exchanged in the steps in the next section. For example, if a purchase order is exchanged in an activity, its precondition to the activity might be 'filled in but unapproved'.

<i>Actor/System/Information/Contract</i>	<i>Preconditions or Assumptions</i>
PQ Instruments	Instruments are monitoring system, are ready to capture data if thresholds are exceeded and all communication systems are working so that notifications can be made if an event is captured

2.1.2 Steps – Normal Sequence

Describe the normal sequence of events, focusing on steps that identify new types of information or new information exchanges or new interface issues to address. Should the sequence require detailed steps that are also used by other functions, consider creating a new “sub” function, then referring to that “subroutine” in this function. Remember that the focus should be less on the algorithms of the applications and more on the interactions and information flows between “entities”, e.g. people, systems, applications, data bases, etc. There should be a direct link between the narrative and these steps.

The numbering of the sequence steps conveys the order and concurrency and iteration of the steps occur. Using a Dewey Decimal scheme, each level of nested procedure call is separated by a dot ‘.’. Within a level, the sequence number comprises an optional letter and an integer number. The letter specifies a concurrent sequence within the next higher level; all letter sequences are concurrent with other letter sequences. The number specifies the sequencing of messages in a given letter sequence. The absence of a letter is treated as a default ‘main sequence’ in parallel with the lettered sequences.

Sequence 1:

*1.1 - Do step 1
1.2A.1 - In parallel to activity 2 B do step 1
1.2A.2 - In parallel to activity 2 B do step 2
1.2B.1 - In parallel to activity 2 A do step 1
1.2B.2 - In parallel to activity 2 A do step 2
1.3 - Do step 3
1.3.1 - nested step 3.1
1.3.2 - nested step 3.2*

Sequence 2:

*2.1 - Do step 1
2.2 - Do step 2*

#	Event	Primary Actor	Name of Process/Activity	Description of Process/Activity	Information Producer	Information Receiver	Name of Info Exchanged	Additional Notes	IECSA Environments
#	<i>Triggering event? Identify the name of the event.¹</i>	<i>What other actors are primarily responsible for the Process/Activity? Actors are defined in section 1.5.</i>	<i>Label that would appear in a process diagram. Use action verbs when naming activity.</i>	<i>Describe the actions that take place in active and present tense. The step should be a descriptive noun/verb phrase that portrays an outline summary of the step. "If ...Then...Else" scenarios can be captured as multiple Actions or as separate steps.</i>	<i>What other actors are primarily responsible for Producing the information? Actors are defined in section 1.5.</i>	<i>What other actors are primarily responsible for Receiving the information? Actors are defined in section 1.5. (Note – May leave blank if same as Primary Actor)</i>	<i>Name of the information object. Information objects are defined in section 1.6</i>	<i>Elaborate architectural issues using attached spreadsheet. Use this column to elaborate details that aren't captured in the spreadsheet.</i>	<i>Reference the applicable IECSA Environment containing this data exchange. Only one environment per step.</i>
1.1	Event Capture	Instrument	Event Capture	If voltage and/or current thresholds are exceeded, the power quality instrument records and event	PowerQuality Instrument	Instrument	Voltage and current waveforms and other power quality data		Inter-Field Equipment

¹ Note – A triggering event is not necessary if the completion of the prior step – leads to the transition of the following step.

#	Event	Primary Actor	Name of Process/Activity	Description of Process/Activity	Information Producer	Information Receiver	Name of Info Exchanged	Additional Notes	IECSA Environments
1.2 A.1	Instrument Event Notification	Instrument	Instrument Event Notification	If an event is triggered, the instrument sends out pages and/or emails to stakeholder recipients	PowerQuality Instrument	Customer	PQ Event data and/or summary data including date, time, magnitude, duration, etc.	Basic telecommunication constraints such as modem and dial up telephone connection, but could also include internet TCP/IP connectivity or even cellular	Intra-Customer Site

#	Event	Primary Actor	Name of Process/Activity	Description of Process/Activity	Information Producer	Information Receiver	Name of Info Exchanged	Additional Notes	IECSA Environments
1.2 B.1	Event Transmittal	Instrument	Event Transmittal	After an event is triggered, the instrument calls back to the central server and the server downloads the data	PowerQuality Instrument	Central Server	Voltage and current waveforms and data	Basic telecommunication constraints such as modem and dial up telephone connection, but could also include internet TCP/IP connectivity or even cellular	Customer / ESP

#	Event	Primary Actor	Name of Process/Activity	Description of Process/Activity	Information Producer	Information Receiver	Name of Info Exchanged	Additional Notes	IECSA Environments
1.2. B.2	Server Event Notification	Central Server	Server Event Notification	After the central server software processes the event data, pages and/or emails are sent out to stakeholders	Central Server	Customer	PQ Event data and/or summary data including date, time, magnitude, duration, etc.	Basic telecommunication constraints such as modem and dial up telephone connection, but could also include internet TCP/IP connectivity or even cellular	Customer / ESP

2.1.3 Steps – Alternative / Exception Sequences

Describe any alternative or exception sequences that may be required that deviate from the normal course of activities. Note instructions are found in previous table.

#	Event	Primary Actor	Name of Process/Activity	Description of Process/Activity	Information Producer	Information Receiver	Name of Info Exchanged	Additional Notes	IECSA Environments

2.1.4 Post-conditions and Significant Results

Describe conditions that must exist at the conclusion of the Function. Identify significant items similar to that in the preconditions section.

Describe any significant results from the Function

<i>Actor/Activity</i>	<i>Post-conditions Description and Results</i>
PQ Instruments	Instruments are monitoring system, are ready to capture data if thresholds are exceeded and all communication systems are working so that notifications can be made if an event is captured

2.2 Architectural Issues in Interactions

Elaborate on all architectural issues in each of the steps outlined in each of the sequences above. Reference the Step by number



Microsoft Excel
Worksheet

2.3 Diagram

For clarification, draw (by hand, by Power Point, by UML diagram) the interactions, identifying the Steps where possible.

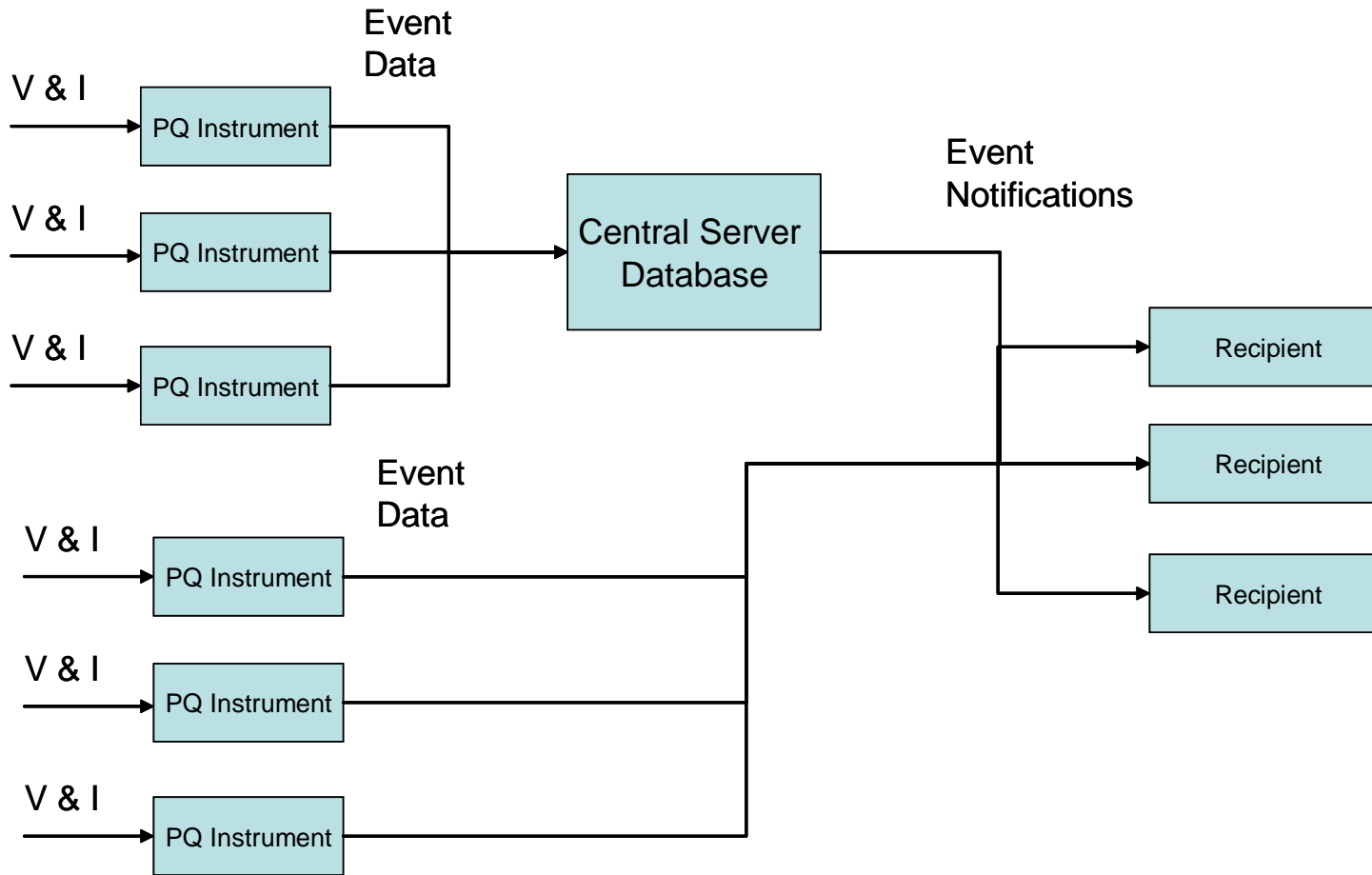

3 Auxiliary Issues

3.1 References and contacts

Documents and individuals or organizations used as background to the function described; other functions referenced by this function, or acting as “sub” functions; or other documentation that clarifies the requirements or activities described. All prior work (intellectual property of the company or individual) or proprietary (non-publicly available) work must be so noted.

ID	Title or contact	Reference or contact information
[1]		
[2]		

3.2 Action Item List

As the function is developed, identify issues that still need clarification, resolution, or other notice taken of them. This can act as an Action Item list.

ID	Description	Status
[1]		
[2]		

3.3 Revision History

For reference and tracking purposes, indicate who worked on describing this function, and what aspect they undertook.

No	Date	Author	Description
0.			

This page intentionally left blank.

RTP Baseline Use Case

1 Descriptions of Function

All prior work (intellectual property of the company or individual) or proprietary (non-publicly available) work should be so noted.

1.1 Function Name

Name of Function

RTP Baseline Use Case

1.2 Function ID

IECSA identification number of the function

C-4

1.3 Brief Description

Describe briefly the scope, objectives, and rationale of the Function.

This use case (narrative only) describes the traditional methods for calculating the real-time pricing structures and discusses in brief, the process of transmitting those prices to participating customers.

1.4 Narrative

A complete narrative of the Function from a Domain Expert's point of view, describing what occurs when, why, how, and under what conditions. This will be a separate document, but will act as the basis for identifying the Steps in Section 2.

Setting Electricity Usage Prices in a RTP Regime

I. Overview

The RTP price in any hour can be represented as follows:

$$\text{Price} = \text{MEC} + \text{MOC} + \text{Retail Adjustments}$$

$$\text{MOC} = \text{GOC} + \text{TOC}$$

$$\text{Adjustments} = \text{RA} + \text{taxes} + \text{surcharges} + \text{LLF}$$

where:

MEC = marginal energy cost

MOC = marginal outage costs

GOC = marginal generation outage cost

TOC = marginal transmission outage cost

RA = risk adjustment factor

LLF = line loss factor.

In its standard application, all of the cost elements that make up the RTP price, except for the line loss factor, which is specific to the subscriber's delivery point, are the same for all subscribers. But, the elements vary in level each hour to reflect changing system supply conditions and lead to RTP prices that can vary widely throughout the year, and even within a individual day. By posting these prices, instead of average cost-based tariffs, the sponsoring utility can access the inherent variability in the value of electricity among subscriber to better match available system supplies with the value of electricity to users.

Marginal Energy Cost (MEC)

Marginal energy cost is the variable cost of serving, or the cost saved by not serving, another kilowatt-hour of energy. The MEC calculation is straightforward and intuitively appealing. For each hour, the scheduler identifies the unit that will serve the marginal load, identifies the appropriate heat rate, associates that with a fuel cost, and calculates the corresponding \$/kwh cost of an incremental load change. Added to this are other costs that vary with the load on the generator, such as lubricants and supervisory and maintenance labor.

Line losses are customer specific in recognition that losses vary according to the delivery voltage at the customer's site. The lower down the transmission and distribution system a customer is served, the higher the loss factor applied. Loss factors are those commonly used for standard rate making purposes.

The risk adder (RA) is a variable factor added in each hour so that RTP prices reflect the value of electricity to customers, and thereby earn margins to offset program costs and reward utility program investments.

In the RTP model, the RA factor provides a revenue stream to cover RTP program costs laid out by the utility. The RA also covers price forecast risks the utility must undertake in setting firm price quotes a day in advance of knowing the actual cost to serve incremental load. The RA serves as a performance incentive for the utility to not only offer RTP, but to operate its units cost effectively at all times. The better the system is operated, the greater the supply availability and therein come opportunities to sell incremental loads and earn incremental returns on the program investment. And as a result all customers realize benefits

Congestion Costs, GOC and TOC

Marginal generation (GOC) and marginal transmission (TOC) costs are somewhat less intuitive at first encounter since they do not represent actual expenditures by the utility as a direct result of changes in the level of incremental load served in each hour. These so-called congestion costs serve a different role--they act as proxies for the usage premiums that a competitive market would impose for consumption during times when capacity is limited and prices would rise to effectively 'ration' available capacity among potential users. First, we will establish the underlying rational and practical application for GOC, and then do the same for TOC.

GOC serves as a proxy for the market clearing price of available capacity in each hour. Imagine a system whose design, development and dispatch is directly overseen by representatives of all customer groups. By agreement, a system reserve margin is set so that marginal capacity investments are made up to the point that customers realize marginal gains in reliability. At that point, any additional investment would not be undertaken because its cost exceeds the value derived by users of the system. Let this reserve margin be *R* (e.g. 18%).

The system dispatcher's job is to establish merit operating order for units of capacity, and see to it that sufficient capacity is available to meet loads plus *R*, the reserve margin. He performs an hourly calculation to determine the unit at the margin and sets MEC. And then he checks to see for the hour what system capacity is available to serve loads.

In cases where there is not sufficient capacity to meet loads and cover the reserve margin, the dispatcher convenes the customer group representatives and offers them two choices; either among themselves they must resolve the discrepancy between the load and reserves available so that the reserve margin R is restored, or by default have the dispatcher go ahead with less than promised reserves and risk random outages. If the representatives are to resolve this situation, some must agree to place themselves in the front of the queue for an outage (should it be necessary) so that others can be more secure and enjoy standard reliability. Clearly the negotiations would revolve around those with very high values associated with maintaining service in that hour that would be seeking to buy security at the lowest possible costs, and those with lower service values who for a bribe would take the exposed positions in the dispatch order.

If this market is to work properly, the representatives must come armed with knowledge of their constituency's value of electric service, or more poignantly, their outage costs--the costs they would incur if they suffered an outage and the price they would accept for reduced reliability. And, the representatives must know what the chances for an outage are, so that they can weight the costs of an outage by its probability and come to a price that they should pay for maintaining reliability, or alternatively, to derive the compensation they would accept for increased exposure to an outage.

If such a market could be operated (which is unlikely in a dispatch environment where decisions must be made each 5-10 seconds, but conceivably could exist on a day-ahead basis to conform with system scheduling--the RTP premise), and customers could indeed conduct negotiations and complete transactions each hour to find a market clearing price for capacity, then over time we would observe a stream of marginal electricity values that correspond to the marginal outage costs of customers. And, we would observe people taking different positions relative to average system reliability based on their value of service. The RTP premise, as currently practiced, tries to emulate this market mechanism through the GOC using a more pragmatic means for establishing market clearing prices.

The GOC used in most RTP programs attempts to replicate this idealized market. The value of lost load (VOLL) plays the role of the customer representatives' outage cost used to evaluate the effect of an outage. The loss of load probability serves to weight these costs according to their likelihood of occurring. The basic equation that reflects the principle we evoke to develop a proxy for a true short-run capacity market among end-users is:

$$GOC = (\text{Probability of an outage}) * (\text{Value of lost load})$$

Engineering calculations can be made each hour to estimate the probability of an outage, commonly referred to as the loss of load probability. It is generally assumed that when system reserves are above the planned level that LOLP is zero, and therefore GOC is also zero. This assumption comes from the notion that if all customers enjoy reliability above that specified in the planning criteria, then there are surpluses available that can be offered without any reliability penalty.

The VOLL is more speculative. But, studies have been undertaken in North America and elsewhere to estimate damage costs and customer willingness-to-pay for greater reliability. These studies find (not surprisingly) that VOLL varies greatly among customer classes and over time. Common practice in RTP programs is to adopt a VOLL value of between \$ 5.00 and \$ 7.00/kwh. So, for example, if in an hour where the MEC was estimated to be \$.020/kwh the LOLP was estimated to be LOLP = .01, then the GOC for that hour if we adopt VOLL = \$7.00/kwh would be \$.07, and the RTP price, excluding retail adjustment, would be \$.09/kwh.

Many utilities have adapted this formulation to accommodate a more common concept used in utility planning and rates circles, marginal capacity cost (MCC). In theory, if capacity investments have been made to satisfy the marginal cost and value equating criteria, then the last unit not yet built is slightly more costly than the marginal outage cost standard for investment. This leads to the “peaker” method often employed to develop a proxy for the marginal cost and value of capacity. Once determined, the marginal capacity cost can be used in place of the VOLL.

One approach for incorporating MCC into the RTP formulation is to calculate the annual carrying cost equivalent of the marginal capacity cost and then convert it to a monthly equivalent that corresponds to a monthly marginal demand charge. This then can be used as the short-run proxy for VOLL and substituted into the equation defined above. If, for example, the annual capacity cost was found to be \$72/kw-year, the monthly equivalent would be \$6.00, which then serves as the VOLL proxy. Since annual marginal capacity costs generally range from \$ 35 to \$75/kw, depending on the type of unit assumed as representative of the marginal

investment, the equivalent marginal capacity cost proxies for VOLL fall into the range of \$3.00 to \$ 6.00, which is consistent with the various outage costs data available and used in RTP programs.

TOC is the equivalent to *GOC* for rationing available transmission capacity. As with *GOC*, the objective is to let customers know when incremental loads will cause transmission system congestion that imposes upon everyone's service reliability. When transmission capacity is abundant, then *TOC* is zero. As transmission capacity becomes committed, past standard loading levels, then the likelihood of an outage increases as does the implied outage cost. Parallel construction of *TOC* to *GOC* is appropriate, but not generally practical.

The difficulty in practice in estimating *TOC* values for each hour is finding an equivalent transmission *LOLP*. Transmission equipment is not generally independently evaluated under probabilistic simulation conditions. Usually, the transmission and distribution systems are evaluated in conjunction with the generation system in power flow models that jointly evaluate different generation availability and line loading conditions. Identifying a unique transmission *LOLP* from within this framework is nearly impossible using standard models. So, even though the *VOLL* concept holds here (after all, customers forego value during outages regardless of whether the cause is generation failure or lack of delivery capacity), there is no easily identifiable analogue to the *LOLP* used in *GOC*.

Utilities who include *TOC* in their RTP prices generally resort to a state variable framework for determining when congestion is a limiting factor and setting a rationing price. Most establish transmission line loading levels for various temperature regimes that they consider to be within the design reliability tolerances, and also establish maximum carrying capacities. Then, using power flow models and experience, a *TOC* schedule is set that equates higher line loadings with a unique *TOC* rationing price, so in practice once the transmission loadings have been established for each hour the *TOC* can be read out directly from the schedule.

The TOC principle is the same as that for GOC--in order to send prices that fully reflect the system and societal costs of usage, some account must be made for the impact of incremental load changes on capacity availability and overall system reliability.

II. Setting Daily RTP prices

In order to offer RTP to customers, the sponsoring utility must develop a pragmatic means for establishing RTP usage prices on a daily basis that correspond to the conceptual principles outlined above. In this section, we will approach the problem functionally. We break the daily RTP price into two elements--wholesale and retail RTP prices--and discuss the various ways that can be adopted to generate the price components of each. This discussion not only addresses procedures and processes, but it also considers how these functional obligations map into routine utility operations. In the next section, we will compare these options and obligations with current operations, identify issues and constraints, and offer recommendations for establishing a smooth and effective process that can be used to support an initial RTP offering.

Offering RTP brings with it the daily responsibility to provide the customer with hourly usage prices. Convention has established 4:00 p.m. as the delivery deadline, although customers appreciate earlier delivery and most utilities send them out when they are ready, which is often soon after 2:00 p.m. This means that those responsible for developing the RTP prices must undertake all data collection, conduct the required analysis, and produce final prices for transmission to customers in that time frame. It is easier to understand and evaluate the needs of this obligation by breaking the RTP prices into two components that correspond to responsibilities that fall to different parts of the utility's organizational structure. Figure 1 displays the various cost elements of the hourly RTP price--marginal energy (MEC), generation (GOC) and transmission (TOC) congestion costs, and retail adjustments, like the adjustment margin (RA).

Wholesale and Retail RTP prices

Wholesale pricing involves estimating the direct costs associated with serving marginal loads in each hour (MEC), and then establishing whether a congestion or reliability fee is applicable and setting the appropriate level of the generation (GOC) and transmission (TOC) cost components.

The retail function is to mark these costs up to reflect losses, to add the appropriate margins to provide product and program returns, and finally to add applicable taxes and surcharges.

Wholesale RTP Prices

Because the wholesale components of the RTP price all relate to the engineering/economics of how generation systems are scheduled and dispatched, this function logically falls to the utility's System Power Operations, particularly the schedulers, who are involved daily in forecasting loads and generation availability for the next day. The scheduler is responsible not only for making a determination of day-ahead capacity availability to fulfill pool and other contractual obligations, his forecasts are vital to wholesale transactions made to either sell generation that will not be needed the next day, or to buy generation to fill capacity voids that are anticipated for the next day. Since schedulers are so fully involved in gathering data and performing analyses that are consistent with establishing RTP cost elements, virtually every utility offering RTP assigns the wholesale RTP pricing function to System Power Operations or its equivalent, and setting daily prices falls to the scheduler.

Schedulers, or their equivalent, are charged with setting marginal energy costs (MECs) for the all hours of the next day, and then establishing hourly measures of reliability and setting corresponding congestion costs.

Marginal Energy Costs (MECs)

A load forecast is developed, the units available for commitment in each hour are ranked by merit order (cost). Then the load forecast for the hour is superimposed to identify the supply unit that will serve the marginal load, and to yield the corresponding MEC fuel cost of that unit. The day-ahead nature of this calculation imposes risks which must be taken into account either by adjustments to the availability of units, or by adding an “uplift” factor to account for erroneous forecasts that result in higher than predicted MECs (most RTP programs quote non-recourse prices, so if it turns out that a more expensive unit serves marginal load, the utility absorbs the loss).

Depending on established practices and the utility’s desire to adopt more extensive procedures, those responsible for setting daily RTP MECs employ one of three methods:

1. Production simulation. If the company maintains a production simulation model for scheduling purposes, then it can be easily deployed for establishing MECs. After entering unit availability for each hour along with a sales forecast, which includes purchases and sales transacted on the wholesale power market, the scheduler performs a simulation run and gets as an output the expected hourly MECs. In the simulation, the model identifies the unit at the margin for each of many different levels of forecasted load and unit availability states and, based on its operating level, establishes a heat rate, which is then converted into a cost (\$/kwh). The mean of the many samples produces the expected costs, the model output MEC for the hour.

For RTP, the scheduler needs to make two additional runs, one with a increment of load increase, and one with a load decrease. The size of the increment should correspond to the amount of RTP subscriber load that is presumed to be price responsive. The average cost to serve the increments over these change cases is then the marginal cost of serving RTP load changes, the base MEC. This is then adjusted upward to account for variable O&M costs associated with the unit operating to produce the final hourly MEC.

MECs produced in this way reflect the utility's expectations for the out-of-pocket costs that would be incurred if an RTP customer, in response to the RTP price, elects to modify his load from the CBL, either up or down.

2. Power Flow Models. An alternative method identified in Figure 6 involves the use of a power flow model. Like its simulation counterpart, it takes as inputs hourly load forecasts and unit availability. But, instead of portraying the system as a set of generators set against a total load requirement, the power flow model includes a representation of the operation of the T&D system that delivers electricity to load centers. Thus, it provides a more complete description of the physical process of meeting dispersed loads from concentrations of generation and thereby incorporates transmission constraints. For the purpose of RTP, a power flow model serves equally well as it provides hourly expected MECs. The important difference is the degree of modeling sophistication and data inputs required to run a power flow model, and the fact that the MECs from a power flow model are more accurate of those likely to transpire, especially when transmission constraints are binding and generation dispatch efficiency is compromised as a result.

Marginal Outage Costs (GOC and TOC).

Marginal outage (also referred to as reliability or congestion) costs reflect the impact of incremental load changes on system reliability. In an open market, available capacity would be auctioned off or sold in spot markets, thereby reconciling any discrepancies between demand and supplies. As supplies dwindle, prices would rise as customers with the highest marginal consumption value would bid up the price to secure capacity. Reliability cost are comprised of two components, generation and transmission reliability costs. Each is discussed in turn below

GOCs

The motivating principle for RTP reliability costs is to use intrinsic engineering and economic relationships to produce prices that mimic market clearing spot prices that would characterize an efficient market. This equation amounts to weighting customers' value of electricity, the VOLL, by the probability that an outage will occur and cause such customer inconvenience and losses as the VOLL implies.

The VOLL is not directly observable since it reflects the marginal consumption values of customers. Outage cost studies have been conducted to try and value outage costs, and they generally find that they vary considerable by time of day, by season, and by customer class and usage characteristics. The probability of an outage is a measurable characteristic of the existing capacity situation, the reliability of the constituent units, and the load forecast and its variance. It too however is easier to describe as a theoretical concepts than to capture in practice.

Two basic approaches are used to set generation reliability costs (GOCs)--1). The first employs the use of a set of state variables that characterize supply and demand states as unique, observable situations that can be assigned an outage cost. The second involves the application of engineering/economic models to directly estimate LOLP and applies a proxy for VOLL to it.

1. The State Variable Method. The state variable method involves conducting studies of system capacity states and corresponding demand conditions and sorting them into categories with identifiable characteristics. System data like line loadings and weather can be used to measure system conditions. Summary information such as the expected system send out as percentage of the historic peak, or of the maximum availability capacity can also be used to establish state categories. Once the system states have been identified, each must be associated with a system reliability level and then a corresponding cost.

For example, the states of supply and demand could be represented by forecasted load as a percentage of available supply capacity. The RTP scheduler takes the load forecast and compares it to available supplies, and determines the resulting expected reserve margin. Then, he compares these available reserves with a predetermined reserve level that

represents the desired reliability, and determines what level of additional reserves are needed to restore the system to its design state of reserves. Finally, this capacity need, which in the RTP regime translates to a desired load reduction by RTP subscribers, is associated with a demand schedule that shows the GOC that is expected to cause subscribers to reduce demands by that amount.

The CBL marks where the customer would operate under tariffs. The RTP scheduler performs a calculation to determine for each hour system reliability expectations. If reliability is expected to be above the design level, he sets GOC at zero--there is no need for rationing. When reserve shortfalls are forecast, then he uses the need/response schedule to find the GOC that will likely bring about that level of load reduction by RTP subscribers.

The greatest advantage of the state variable approach, simplicity and easy of use, is also its biggest downfall, at least compared to the theoretical notion for which it serves as a proxy. The simplistic representation assumes that the demand curve for subscribers is well known, so that the scheduler has a reliable means of associating needs with a unique price that will realize them. In practice, very little is known about customer response to RTP.

None-the-less, this method has gained favor among utilities who want an easier, more intuitive means of setting GOCs in a pilot RTP program. They believe that this method will produce logical, if not always exactly accurate GOCs, and in doing so at a low cost and with high subscriber acceptance they expedite getting RTP in the field. And, they argue that over time customer price response to RTP prices will reveal the nature of the underlying response curve, the demand for electricity, and that this finding will not only lead to improved RTP program performance, but also provide data of significant strategic value.

Others argue that when the system is characterized by only a few units of nearly equal size and reliability, that there only a few reliability state of interest in setting GOC, and therefore the more elaborate engineering LOLP method is overkill--the state variable approach will accurately capture the important events and provide theoretically correct signals to RTP subscribers. Here, the model's simplicity is its best asset.

Finally, the state variable approach has appeal to those who see RTP as having two distinct elements, a load growth and a load control aspect. MECs are the load growth signal, since even the highest MEC is seldom much higher than the average usage price under tariffs. GOC serves as a load control device, evoked only when the Scheduler wants to change the RTP signal from “Go ahead and increase usage, capacity is available!” to “Shed all loads of marginal importance because we need load relief.” Under this philosophy, the need/response method of setting GOC provides the very price controls the scheduler requires to be able to change the price signal from one state to the other.

The EUE/VOLL Method. The alternative GOC methodology seeks to develop daily forecasts of the elements of the basic GOC equation. This means establishing parameter levels for each hour for the VOLL and the LOLP.

As with the state variable method, the scheduler first develops reserve estimates for each hour, using the load forecast and the level of available capacity. In the EUE/VOLL method, he then compares these not to a need/response curve, but to a schedule that relates reserves to the probability of an outage. The lower the reserves, the greater the probability; when reserves exceed a predetermined “safe” level, LOLP is zero. The LOLP level is then multiplied by the VOLL to arrive at the GOC price for that hour, following the basic GOC formulation.

The elusiveness, some would say arbitrariness, of the VOLL causes skeptics to regard this as little better than arbitrary value-based pricing. They also point to the futility of ever being able to specify the reserves/probability of an outage relationship in any unique and stable manner. But, given that the underlying basis for GOC is defined in terms of probabilities and customer values, and that analogous measures can be developed using established and accepted models, there has been strong support among utilities who offer RTP for the EUE/VOLL method.

Moreover, systems that have converted to pool pricing as the basis for their electricity markets, most notably England, New Zealand, and Victoria, Australia, have adopted this method, legitimizing its use and advancing the methods available to support its application in RTP.

Retail RTP Prices

Retail prices are derived from the wholesale prices quoted for each hour--the wholesale prices represent a floor price that the product manager then uses as the basis for setting usage prices for the various RTP products.

III. Quoting RTP Prices at RTP UTILITY

In order to support a RTP program, the requisite organizational infrastructure and functional processes must be established. Responsible entities must be chartered and provided the resources to choose among the various methods available for preparing hourly wholesale and retail price quotes, develop the necessary procedures and models, supervise their daily application, and review their performance over time.

Functional Elements

The functional elements required for RTP wholesale pricing are reviewed below, followed by recommendations for integrating them under consistent leadership so that wholesale and retail RTP prices can be reliably and accurately quoted on a daily basis.

Load Forecasts. The Systems Operations department issues an hourly load forecast for the next day at about 8:00 a.m. The major client for this forecast is Off-System Sales, who uses it in conjunction with information about unit availability to determine excess capacity that can be sold. The current forecast process is based on high-level temperature relationships that have been established from historic data, and that appear to be quite reliable. System Operations is investigating more sophisticated and intricate forecasting systems, like neural-networks, in order to improve both forecast accuracy and to realize greater automation. These improvements will find great value in forecasting more accurate RTP prices.

Estimating Marginal Energy Cost (MEC). The System Planning department supports a probabilistic simulation model. This model is normally used for longer term planning studies of capacity needs, to estimate system operating costs, and to some extent to evaluate off-system sales opportunities. The simulation is a flexible modeling framework for evaluating not only the utilities capacity situation, but it can also represent the utility system, which is critical to understanding how marginal transactions influence the utility margins and earnings. This is a powerful tool that can serve many roles for the RTP program.

The model could be calibrated regularly to represent the utility's unit availability, and then run each day to provide capacity availability for Off-System Sales, and then rerun later to provide hourly MECs for the RTP program. Early morning load forecasts (available by 9:00 a.m.) could be entered into the model along with updated unit availability data, and information about the larger utility system. With this data bank, a system scheduler could perform standardized simulations to produce an hourly schedule of unit availability for off system sales along with floor prices--the minimum transaction price of such sales. Naturally, these minimum prices would reflect marginal unit operating costs. But other factors might also enter into setting floor prices, such as minimum margins that reflect the value of the unit if dispatched inside of the utility. As RTP matures and more is learned about customer electricity values, utilities may want to set a "reservation" price that reflects the expected price that surplus capacity will bring when offered later in the day for RTP.

Then, after all off-system transactions are completed, the model could be updated with regard to capacity availability. A change-case run that looks at load decrements and increments that reflects the size of the likely RTP price responsive load would then provides the MECs needed for hourly RTP prices. MECs developed in this way would conform to current standard

practices of major RTP sponsoring utilities, and would ensure that RTP usage prices are truly reflective of underlying cost to serve incremental load in each hour.

Because RTP prices are subject to subsequent mark-up and other modifications, there is a tendency to assume that MEC forecast accuracy is not so important. And, initially this may be the case. But, as RTP markets mature and competition becomes sharper, winning profitable sales will depend on knowing exact supply costs. A RTP program provides the focus and motivation to first pursue conceptually the notion of MEC, and to adopt pragmatic methods to support the initiation of an RTP program. It should also serve to focus attention on the need to constantly evaluate these methods and to propose and pursue ways to improve them.

Estimating Generation Outage Costs (GOC) and Transmission Outage Costs (TOC). The model discussed above could be used to calibrate a Loss of Load Probability (LOLP)/Reserves schedule, as long as some factor analogous to reserves can be identified and measured. The utility operates within a much larger pool that it does not control, and whose capacity state will be difficult to discern on a day-ahead basis. To ignore the pool capacity would understate, on most days, the true reserve situations and cause congestion costs to be added to the MEC too often, and be too large when evoked. But, capacity availability is not infinite, so to ignore real constraints to serving marginal load invites customers to expand their usage, only to find that in the short run, on some occasions the RTP price induced load growth causes system shortfalls and outages to other customers that otherwise would not have transpired. Alternatively, load growth so induced may trigger utility pool penalties that are assessed against all customers of the utility.

TOCs

TOC are the equivalent to GOC but they apply to transmission system capacity, constraints, and outage costs. Investigations into these relationships need to be conducted before a methodology to establishing TOCs, when warranted, can be recommended

Overall RTP Program Organization

RTP is a unique product, unlike traditional electric rates and services. The RTP Subscriber becomes connected directly to decisions made every day by system operations. The fundamental language of RTP, the prices set each hour for usage, vary first and foremost according to how the system responds to changing load demands and supply availability. RTP subscribers must be convinced that the prices that are quoted reflect actual system conditions, and are not being manipulated to coerce them to extract greater revenues. Building customer trust is critical, so that they will accept that the price variability is real, invest in understanding these price patterns and how they correspond to the value of electricity to their operations, and devise ways to become price responsive. RTP is only worth the effort and costs if customers become price responsive, thereby generating net benefits to themselves, to other ratepayers, and to shareholders.

The product structure organizes wholesale and retail responsibilities into separate operational units, each reporting to a RTP Program Management Committee. The committee is comprised of representatives of the various departments who are involved in the RTP program, and can include external members who act as advisors. The committee establishes program objectives, sets performance goals, and approves program budgets. Since this is an overlay organization, the committee is responsible for translating the overall objectives into performance goals that can be exclusively and exhaustively assigned to one or more organizational departments. Where a goal requires that two separate departments accept responsibility, the committee must ensure that the proper working arrangements are put in place and accepted by the responsible managers, so that these departments have shared goals consistent with overall program needs and goals.

Two major functions are under the direction of the RTP Committee--Wholesale Pricing and Retail Product Management. We propose that the retail functions be assigned to a Product Manager who is charged with carrying out all activities associated with designing, marketing, supporting, and evaluating the RTP product in the market place. The wholesale functions are assigned to a Wholesale Pricing Manager, whose job is to make sure that the responsible departments and their staff have the resources needed to produce daily RTP wholesale price quotes, and that they meet these obligations routinely and to accepted standards of performance.

Wholesale RTP Pricing

Power Systems Operations

Power Systems Operations (PSO), is responsible for carrying out the daily tasks associated with preparing wholesale RTP prices. PSO manages all unit scheduling functions, both to serve RTP and for other corporate purposes. It is responsible for making off-system sales, and it is responsible for the dispatch and the monitoring and control of the utilities generation units.

Scheduling.

MECs

To serve as the estimator of MECs, the utility establishes a base model configuration that defines existing capacity plans and availability, and links unit operations to variable costs. Those costs should include not only fuel costs, derived from unit heat rates and fuel inventory costs, but also provide for the addition of other variable O&M costs. These latter costs could be established outside the modeling environment and attached to unit marginal costs, once established, from a look-up file. This base case file then serves daily as the basis for performing simulations to determine marginal units and corresponding MECs. The base case requires scrutiny and adjustments as the supply situation changes, as new units or supply sources are added to the generations mix, or as transmission or other operating constraints alter the basic merit order dispatch logic.

The scheduler then daily enters the next day hourly load forecasts, along with any changes in unit availability and operating characteristics into the model. A base run performed early in the morning could then be used by the off system sales agents to determine what capacity is available to sell, and what prices they should seek. Later, when off system transactions have been completed, the scheduler again updates his files and then performs a change case run, by adding and subtracting fixed increment of load to the base forecast. Modifications to the model would facilitate not only setting up the daily runs, but also extracting the required hourly data and preparing an output.

GOC and TOCs

The system model could be used to calibrate a LOLP/Reserves schedule, as long as some factor analogous to reserves can be identified and measured. The utility operates within a much larger pool that it does not control, and whose capacity state will be difficult to discern on a day-ahead basis. To ignore the pool capacity would understate, on most days, the true reserve situations and cause congestion costs to be added to the MEC too often, and be too large when evoked. But, capacity availability is not infinite, so to ignore real constraints to serving marginal load invites customers to expand their usage, only to find that in the short run, on some occasions the RTP price induced load growth causes system shortfalls and outages to other customers that otherwise would not have transpired. Alternatively, load growth so induced may trigger utility pool penalties that are assessed against all customers of the utility.

TOC are the equivalent to GOC but they apply to transmission system capacity, constraints, and outage costs. Investigations into these relationships need to be conducted before a methodology to establishing TOCs, when warranted, can be recommended

Off-System Sales

Off-System sales are fully integrated with other activities associated with managing scheduling and dispatch, including establishing daily reserve requirements, sales opportunities, and the prices that should be charged for reserves. Specifically, by integrating off-system sales into an overall wholesale pricing function, the utility will look at the marginal value of its available resources in all markets, and then seek out merchandising opportunities, both wholesale and retail, that maximize the returns for such sales.

Dispatch and SCADA

For the purpose of RTP, the Dispatch and SCADA organization is responsible for acquiring plant operating data and developing up-to-date databases that would serve as inputs to the models operated by the scheduler. Dispatch also would each morning develop hourly load forecasts for the next business day, and several days' forecasts on weekends and holidays, and store them in a database, again so that they can be accessed by the scheduler.

System Planning

Model Development

Since the models and methods that will be deployed for RTP involve intricate programs and databases, we suggest that responsibility for designing, commissioning, testing and supporting these models be given to System Planners. Calibrating these models requires the close coordination with planning activities, as the RTP models used daily will provide reliable and consistent

cost estimates only as long as they simulate the system condition. Planners regularly examine large-scale issues that effect system capacity and loads, and therefore they are best equipped to serve the role of establishing model requirements and assisting model users in maintaining well-calibrated models.

Price Quotation Evaluation

System Planning conducts such studies as are required to evaluate the performance of the wholesale price setting models and procedures. This includes conducting comparisons of actual and forecasted RTP prices, decomposing the variances into fundamental elements, diagnosing problems and offering solutions. This charter extends to evaluating not only the RTP prices, but also the process for establishing daily floor prices for off-system sales transactions, so that daily operations can be improved, especially where the sales balance between the off system and RTP market are not well aligned with the relative returns realized in each market.

Daily Flow of Information for RTP Wholesale Pricing

The System Operations department produces early morning forecasts that the Scheduler uses to prepare unit availability and floor prices for off-system sales. The Off System Sales (OSS) department evaluates market opportunities and seeks to maximize the return from sales to other systems. After exercising those contracts that are beneficial, OSS sends back to the Scheduler closed transactions and any other relevant market information. Following this regimen, by noon the Scheduler is ready to set minimum prices for RTP sales, the wholesale RTP prices.

The Scheduler adjusts the simulation model databases to reflect the off-system sales and adds any other relevant data and then performs a routine, specified simulation to generate MECs, by hour, for the next day. Then using an as yet to be determined process, he identifies hours when congestion costs, GOC and TOC, are to be invoked and adds the appropriate values. The result is a set of hourly RTP wholesale prices that are forwarded to the Retail Product Center by 2:00. Wholesale prices are converted to retail prices by the RTP Product Center and transmitted to RTP subscribers via email or fax.

Glossary of Terms and Acronyms

Congestion Cost - also referred to (see) as cost.

Distribution Outage Costs (DOC) - the costs incurred by end-users associated with the failure of the distribution system to carry connected load, resulting in an outage at some customer sites. Unlike MOC and TOC, which are system-level measures, DOCs are localized phenomena and need to reflect the composition of customers served on the part of the distribution system under scrutiny.

Expected Unserved Energy (EUE) - LOLP measures the instance of load being greater than the generation and other dispatchable resources available to meet it. EUE measures at each such occurrence the amount of load that went unserved, the total kilowatt-hours of outages that resulted.

Generation Outage Costs (GOC) - outage costs associated with the insufficiency of generation supply resources to meet connected and demanded loads.

Loss of Load Probability (LOLP) - a measure of the probability of the occurrence of a state where the total load demanded by end-users can not be met by available generation (or transmission) capacity. It is the likelihood of an outage on some part of the system. LOLP is a measure of system reliability. The lower the LOLP, the more reliable the electric service. A conventional standard in utility planning is to add sufficient capacity until the LOLP is one day in ten years. The application of this standard to system load and capacity conditions yields a planned reserve margin, the minimum amount of surplus capacity over peak loads that the utility plans to have available.

Line Losses - marginal energy costs are estimated at the busbar, where the generation unit first connects to the transmission system. Customers take delivery at various points on the transmission and distribution system. Losses reflect energy dissipation as electricity flows through the wires, and through its transformation down to lower delivery levels. Standard rates include loss factors applicable to the various levels of delivery, transmission, subtransmission, and distribution, and for transformation losses when the customer is metered on the low voltage side of a utility owned transformer. These factors are used to mark off wholesale RTP prices to reflect the higher generation output required to deliver energy to the end-use customer.

Marginal Energy Cost (MEC) - the variable generation operating cost incurred to serve an incremental unit of load, or the cost saved from an increment in load reduction. Convention measures energy costs in dollars per kilowatt-hours. As a marginal measure, its level is dependent upon the load level from which the increment is measured, and the size of the increment. In its strictest interpretation, the increment is one kW(h). In practice, the models and methods employed to estimate or measure MEC require a larger increment of load change, often as large as 10 megawatts, more which exceeds the total load of all but a few customers. Therefore, MEC is an illustrative and generic measure that in practice cannot be associated directly with the actions of any one customer. The point on the demand for electricity curve where MEC is measured is a function of the purpose at hand. For RTP, that measurement is taken at the level of wholesale and retail load forecast to be on line in the hour in which prices are being set.

Marginal Capacity Cost (MCC) - measures the cost of capacity associated with the unit that would be added, or the resources rights that would be purchased, to serve incremental load. MCC usually is measured in reference to additions to system peak loads, in terms of dollar per kilowatt of additional capacity added.

Marginal Outage Costs (MOC) - the change in outage costs associated with a change in load, at some specified load level and at a given load increment. For RTP, the increment is usually set at the maximum level of load change that RTP subscribers are likely to undertake in response to RTP prices, although in practice minimum increments required by models used to measure MOC are larger than these increments.

Outage Costs - the costs incurred by customers when electric service is curtailed or interrupted. Curtailments refer to situations where the customer received notice of a pending service outage. Interruptions are no-notice service outages. Outage costs (what?)

Planned Reserve Margin - the level of reserves at the peak load hour that, by design, is available to back up dispatched generation.

Real-Time Pricing (RTP) - a retail electricity pricing system whereby customers are quoted hourly prices for usage. Generally, RTP subscribers receive these price quoted a business-day in advance, by 4:00 p.m. But, in specialized applications, final usage prices are sent to subscribers only an hour in advance of their applicability. RTP services are offered as optional services to utility retail customers under term contract arrangements. Because usage prices are set daily and for each hour individually, RTP requires customers to respond to marginal, not average supply costs and thereby the efficiency of resource utilization increases.

Retail Pricing - the process of setting final consumption prices for RTP subscribers. Wholesale prices set the floor for retail prices, which include mark-ups for margin, taxes, surcharges, line losses, etc.

Risk Adjustment (RA) - is a variable factor added in each hour so that RTP prices reflect the value of electricity to customers, and thereby earn margins to offset program costs and reward utility program investments.

System Control and Data Acquisition System (SCADA) - refers to metering devices, the communication network that ties these meters to a central data base, and the control software and procedures that execute logical tasks based on the data collected. SCADA systems generally refer to meters that measure current, voltage and other aspects of electrical flow at various points on the transmission system, including the output of generators, the flows at major transmission ties, and flows into substations and radial distribution networks.

Transmission Outage Costs (TOC) - The costs incurred by end-users associated with the failure of the transmission system to carry connected load, resulting in an outage at some customer sites.

Value of Lost Load (VOLL) - measures the inconvenience, damage and replacement costs that customers incur when service is curtailed or interrupted.

Wholesale pricing- refers to identifying the underlying variable operating and outage costs associated with serving incremental load.

1.5 Actor (Stakeholder) Roles

Describe all the people (their job), systems, databases, organizations, and devices involved in or affected by the Function (e.g. operators, system administrators, technicians, end users, service personnel, executives, SCADA system, real-time database, RTO, RTU, IED, power system). Typically, these actors are logically grouped by organization or functional boundaries or just for collaboration purpose of this use case. We need to identify these groupings and their relevant roles and understand the constituency. The same actor could play different roles in different Functions, but only one role in one Function. If the same actor (e.g. the same person) does play multiple roles in one Function, list these different actor-roles as separate rows.

<i>Grouping (Community)</i>		<i>Group Description</i>
<i>Actor Name</i>	<i>Actor Type (person, device, system etc.)</i>	<i>Actor Description</i>

Replicate this table for each logic group.

1.6 Information exchanged

Describe any information exchanged in this template.

<i>Information Object Name</i>	<i>Information Object Description</i>

1.7 Activities/Services

Describe or list the activities and services involved in this Function (in the context of this Function). An activity or service can be provided by a computer system, a set of applications, or manual procedures. These activities/services should be described at an appropriate level, with the understanding that sub-activities and services should be described if they are important for operational issues, automation needs, and implementation reasons. Other sub-activities/services could be left for later analysis.

<i>Activity/Service Name</i>	<i>Activities/Services Provided</i>

1.8 Contracts/Regulations

Identify any overall (human-initiated) contracts, regulations, policies, financial considerations, engineering constraints, pollution constraints, and other environmental quality issues that affect the design and requirements of the Function.

<i>Contract/Regulation</i>	<i>Impact of Contract/Regulation on Function</i>

<i>Policy</i>	<i>From Actor</i>	<i>May</i>	<i>Shall Not</i>	<i>Shall</i>	<i>Description (verb)</i>	<i>To Actor</i>

<i>Constraint</i>	<i>Type</i>	<i>Description</i>	<i>Applies to</i>

2 Step by Step Analysis of Function

Describe steps that implement the function. If there is more than one set of steps that are relevant, make a copy of the following section grouping (Preconditions and Assumptions, Steps normal sequence, and Steps alternate or exceptional sequence, Post conditions)

2.1 Steps to implement function

Name of this sequence.

2.1.1 Preconditions and Assumptions

Describe conditions that must exist prior to the initiation of the Function, such as prior state of the actors and activities

Identify any assumptions, such as what systems already exist, what contractual relations exist, and what configurations of systems are probably in place

Identify any initial states of information exchanged in the steps in the next section. For example, if a purchase order is exchanged in an activity, its precondition to the activity might be 'filled in but unapproved'.

<i>Actor/System/Information/Contract</i>	<i>Preconditions or Assumptions</i>

2.1.2 Steps – Normal Sequence

Describe the normal sequence of events, focusing on steps that identify new types of information or new information exchanges or new interface issues to address. Should the sequence require detailed steps that are also used by other functions, consider creating a new “sub” function, then referring to that “subroutine” in this function. Remember that the focus should be less on the algorithms of the applications and more on the interactions and information flows between “entities”, e.g. people, systems, applications, data bases, etc. There should be a direct link between the narrative and these steps.

The numbering of the sequence steps conveys the order and concurrency and iteration of the steps occur. Using a Dewey Decimal scheme, each level of nested procedure call is separated by a dot ‘.’. Within a level, the sequence number comprises an optional letter and an integer number. The letter specifies a concurrent sequence within the next higher level; all letter sequences are concurrent with other letter sequences. The number specifies the sequencing of messages in a given letter sequence. The absence of a letter is treated as a default ‘main sequence’ in parallel with the lettered sequences.

Sequence 1:

*1.1 - Do step 1
1.2A.1 - In parallel to activity 2 B do step 1
1.2A.2 - In parallel to activity 2 B do step 2
1.2B.1 - In parallel to activity 2 A do step 1
1.2B.2 - In parallel to activity 2 A do step 2
1.3 - Do step 3
1.3.1 - nested step 3.1
1.3.2 - nested step 3.2*

Sequence 2:

*2.1 - Do step 1
2.2 - Do step 2*

#	Event	Primary Actor	Name of Process/Activity	Description of Process/Activity	Information Producer	Information Receiver	Name of Info Exchanged	Additional Notes	IECSA Environments
#	Triggering event? Identify the name of the event. ¹	What other actors are primarily responsible for the Process/Activity? Actors are defined in section 1.5.	Label that would appear in a process diagram. Use action verbs when naming activity.	Describe the actions that take place in active and present tense. The step should be a descriptive noun/verb phrase that portrays an outline summary of the step. "If ...Then...Else" scenarios can be captured as multiple Actions or as separate steps.	What other actors are primarily responsible for Producing the information? Actors are defined in section 1.5.	What other actors are primarily responsible for Receiving the information? Actors are defined in section 1.5. (Note – May leave blank if same as Primary Actor)	Name of the information object. Information objects are defined in section 1.6	Elaborate architectural issues using attached spreadsheet. Use this column to elaborate details that aren't captured in the spreadsheet.	Reference the applicable IECSA Environment containing this data exchange. Only one environment per step.

2.1.3 Steps – Alternative / Exception Sequences

Describe any alternative or exception sequences that may be required that deviate from the normal course of activities. Note instructions are found in previous table.

#	Event	Primary Actor	Name of Process/Activity	Description of Process/Activity	Information Producer	Information Receiver	Name of Info Exchanged	Additional Notes	IECSA Environments

¹ Note – A triggering event is not necessary if the completion of the prior step – leads to the transition of the following step.

2.1.4 Post-conditions and Significant Results

Describe conditions that must exist at the conclusion of the Function. Identify significant items similar to that in the preconditions section.

Describe any significant results from the Function

<i>Actor/Activity</i>	<i>Post-conditions Description and Results</i>

2.2 Architectural Issues in Interactions

Elaborate on all architectural issues in each of the steps outlined in each of the sequences above. Reference the Step by number..

2.3 Diagram

For clarification, draw (by hand, by Power Point, by UML diagram) the interactions, identifying the Steps where possible.

3 Auxiliary Issues

3.1 References and contacts

Documents and individuals or organizations used as background to the function described; other functions referenced by this function, or acting as “sub” functions; or other documentation that clarifies the requirements or activities described. All prior work (intellectual property of the company or individual) or proprietary (non-publicly available) work must be so noted.

ID	Title or contact	Reference or contact information
[1]		
[2]		

3.2 Action Item List

As the function is developed, identify issues that still need clarification, resolution, or other notice taken of them. This can act as an Action Item list.

ID	Description	Status
[1]	Use case to be completed	Will have to be picked up by another resource
[2]		

3.3 Revision History

For reference and tracking purposes, indicate who worked on describing this function, and what aspect they undertook.

No	Date	Author	Description
0.1	3/2/04	Jack King	Fomatted initial narrative into Version 27(28) template.

This page intentionally left blank.

RTP – Market Operations Energy Services

1 Descriptions of Function

All prior work (intellectual property of the company or individual) or proprietary (non-publicly available) work should be so noted.

1.1 Function Name

RTP – Market Operations Energy Services

1.2 Function ID

IECSA identification number of the function

C-4

1.3 Brief Description

Describe briefly the scope, objectives, and rationale of the Function.

Market Operations Energy Services, for the purposes of this use case, collects bid and offers into the energy market from Energy Service Providers (EnergyServiceProvider) and other aggregators of distributed energy resources.

1.4 Narrative

A complete narrative of the Function from a Domain Expert's point of view, describing what occurs when, why, how, and under what conditions. This will be a separate document, but will act as the basis for identifying the Steps in Section 2.

For this use case, the EnergyServiceProvider or other aggregator submits bids and/or offers based upon bids and offers made by their customers. The aggregator may submit bids in several tiers to accommodate a range in quality and price of services.

Market Operations Energy Services, for the purposes of this use case, collects bid and offers into the energy market from Energy Service Providers (EnergyServiceProvider) and other aggregators of distributed energy resources. MarketOperationSystem evaluates

incoming bids against needs and accepts or rejects those offers. The detailed process for evaluating bids and offers is detailed in MarketOperationSystem cone, Day Ahead use cases.

Once the bids and offers are evaluated and accepted or declined, the results are posted on the marker interface server is used or transmitted to the EnergyServiceProvider for scheduling and action.

1.5 Actor (Stakeholder) Roles

Describe all the people (their job), systems, databases, organizations, and devices involved in or affected by the Function (e.g. operators, system administrators, technicians, end users, service personnel, executives, SCADA system, real-time database, RTO, RTU, IED, power system). Typically, these actors are logically grouped by organization or functional boundaries or just for collaboration purpose of this use case. We need to identify these groupings and their relevant roles and understand the constituency. The same actor could play different roles in different Functions, but only one role in one Function. If the same actor (e.g. the same person) does play multiple roles in one Function, list these different actor-roles as separate rows.

<i>Grouping (Community)'</i>		<i>Group Description</i>
<i>MarketOperationSystem</i>		
<i>Actor Name</i>	<i>Actor Type (person, device, system etc.)</i>	<i>Actor Description</i>
BidEvaluationSystem	System	Evaluates bids and offers for energy services and accepts those that meet the criteria established by the market opertator.
MarketInterfaceServer	System	Provides access to market information to ESPs and other market participants.
MarketOperationSystem	Community	this

<i>Grouping (Community)'</i>		<i>Group Description</i>
<i>Energy Service Providers</i>		<i>Provide Energy to end use customers</i>
<i>Actor Name</i>	<i>Actor Type (person, device, system etc.)</i>	<i>Actor Description</i>
EnergyService Provider Aggregation System	System	Combines and rates the incoming bids and aggregates them into a single or few large bids for submission to the Market Operation Energy and Ancillary Services Bid/Offer system.
EnergyService Provider	Community	this

Replicate this table for each logic group.

1.6 Information exchanged

Describe any information exchanged in this template.

<i>Information Object Name</i>	<i>Information Object Description</i>
Aggregate energy bids and offers	Bids and offers for energy resources offered through the EnergyServiceProvider aggregation system
Accepted energy bids and offers	Accepted offers and bids returned to the EnergyServiceProvider for action

1.7 Activities/Services

Describe or list the activities and services involved in this Function (in the context of this Function). An activity or service can be provided by a computer system, a set of applications, or manual procedures. These activities/services should be described at an appropriate level, with the understanding that sub-activities and services should be described if they are important for operational issues, automation needs, and implementation reasons. Other sub-activities/services could be left for later analysis.

<i>Activity/Service Name</i>	<i>Activities/Services Provided</i>

1.8 Contracts/Regulations

Identify any overall (human-initiated) contracts, regulations, policies, financial considerations, engineering constraints, pollution constraints, and other environmental quality issues that affect the design and requirements of the Function.

<i>Contract/Regulation</i>	<i>Impact of Contract/Regulation on Function</i>
Accepted Bid or Offer	Constitutes a contract to provide the bid service at the specified time

<i>Policy</i>	<i>From Actor</i>	<i>May</i>	<i>Shall Not</i>	<i>Shall</i>	<i>Description (verb)</i>	<i>To Actor</i>
Provide Service	EnergyServiceProvider			X	Provide accepted services as bid	MarketOperationSystem

<i>Constraint</i>	<i>Type</i>	<i>Description</i>	<i>Applies to</i>
Laws of physics	Environmental	Laws of physics for power system operations	All
Technology	Environmental	Technology constraints for providing real-time pricing information to all customers with RTP as part of their customer tariffs	All
Security	Environmental	Security policies and technologies must be established and used to address all security needs at the appropriate/contracted levels	All

2 Step by Step Analysis of Function

Describe steps that implement the function. If there is more than one set of steps that are relevant, make a copy of the following section grouping (Preconditions and Assumptions, Steps normal sequence, and Steps alternate or exceptional sequence, Post conditions)

2.1 Steps to implement function

Name of this sequence.

2.1.1 Preconditions and Assumptions

Describe conditions that must exist prior to the initiation of the Function, such as prior state of the actors and activities

Identify any assumptions, such as what systems already exist, what contractual relations exist, and what configurations of systems are probably in place

Identify any initial states of information exchanged in the steps in the next section. For example, if a purchase order is exchanged in an activity, its precondition to the activity might be 'filled in but unapproved'.

<i>Actor/System/Information/Contract</i>	<i>Preconditions or Assumptions</i>
EnergyServiceProvider	Completed aggregation of energy services bids and offers.

2.1.2 Steps – Normal Sequence

Describe the normal sequence of events, focusing on steps that identify new types of information or new information exchanges or new interface issues to address. Should the sequence require detailed steps that are also used by other functions, consider creating a new “sub” function, then referring to that “subroutine” in this function. Remember that the focus should be less on the algorithms of the applications and more on the interactions and information flows between “entities”, e.g. people, systems, applications, data bases, etc. There should be a direct link between the narrative and these steps.

The numbering of the sequence steps conveys the order and concurrency and iteration of the steps occur. Using a Dewey Decimal scheme, each level of nested procedure call is separated by a dot ‘.’. Within a level, the sequence number comprises an optional letter and an integer number. The letter specifies a concurrent sequence within the next higher level; all letter sequences are concurrent with other letter sequences. The number specifies the sequencing of messages in a given letter sequence. The absence of a letter is treated as a default ‘main sequence’ in parallel with the lettered sequences.

Sequence 1:

*1.1 - Do step 1
1.2A.1 - In parallel to activity 2 B do step 1
1.2A.2 - In parallel to activity 2 B do step 2
1.2B.1 - In parallel to activity 2 A do step 1
1.2B.2 - In parallel to activity 2 A do step 2
1.3 - Do step 3
1.3.1 - nested step 3.1
1.3.2 - nested step 3.2*

Sequence 2:

*2.1 - Do step 1
2.2 - Do step 2*

#	Event	Primary Actor	Name of Process/Activity	Description of Process/Activity	Information Producer	Information Receiver	Name of Info Exchanged	Additional Notes	IECSA Environments
#	Triggering event? Identify the name of the event. ¹	What other actors are primarily responsible for the Process/Activity? Actors are defined in section 1.5.	Label that would appear in a process diagram. Use action verbs when naming activity.	Describe the actions that take place in active and present tense. The step should be a descriptive noun/verb phrase that portrays an outline summary of the step. "If ...Then...Else" scenarios can be captured as multiple Actions or as separate steps.	What other actors are primarily responsible for Producing the information? Actors are defined in section 1.5.	What other actors are primarily responsible for Receiving the information? Actors are defined in section 1.5. (Note – May leave blank if same as Primary Actor)	Name of the information object. Information objects are defined in section 1.6	Elaborate architectural issues using attached spreadsheet. Use this column to elaborate details that aren't captured in the spreadsheet.	Reference the applicable IECSA Environment containing this data exchange. Only one environment per step.
1.1	EnergyServiceProvider aggregates bids and offers	EnergyServiceProvider Aggregation System		EnergyServiceProvider transmits energy bid/offer data to market operations	EnergyServiceProvider	MarketInterfaceServer	Aggregate energy bids and offers		RTOs / Market Participants
1.2	Completion of previous Step	BidEvaluationSystem		Bid evaluation system processes loads data from market interface server. Bids are processed and evaluated against needs for the period. Some or all of the bids maybe accepted or rejected.	MarketInterfaceServer	BidEvaluationSystem	Aggregate energy bids and offers		RTOs / Market Participants
1.3	Completion of previous Step	BidEvaluationSystem		Acceptance or rejections status is transferred to the market interface server	BidEvaluationSystem	MarketInterfaceServer	Accepted energy bids and offers		RTOs / Market Participants

¹ Note – A triggering event is not necessary if the completion of the prior step – leads to the transition of the following step.

#	Event	Primary Actor	Name of Process/Activity	Description of Process/Activity	Information Producer	Information Receiver	Name of Info Exchanged	Additional Notes	IECSA Environments
1.4	Timer	EnergyServiceProvider		EnergyServiceProvider polls Market Server for bid status. Status is transferred to the EnergyServiceProvider Aggregation System,	MarketInterfaceServer	EnergyServiceProvider Aggregation System	Accepted energy bids and offers		RTOs / Market Participants

2.1.3 Steps – Alternative / Exception Sequences

Describe any alternative or exception sequences that may be required that deviate from the normal course of activities. Note instructions are found in previous table.

#	Event	Primary Actor	Name of Process/Activity	Description of Process/Activity	Information Producer	Information Receiver	Name of Info Exchanged	Additional Notes	IECSA Environments

2.1.4 Post-conditions and Significant Results

Describe conditions that must exist at the conclusion of the Function. Identify significant items similar to that in the preconditions section.

Describe any significant results from the Function

<i>Actor/Activity</i>	<i>Post-conditions Description and Results</i>
EnergyServiceProvider	Committed to providing accepted aggregated energy bids.

<i>Actor/Activity</i>	<i>Post-conditions Description and Results</i>
MarketOperationSystem	Committed to honoring accepted Energy services bids and offers.

2.2 Architectural Issues in Interactions

Elaborate on all architectural issues in each of the steps outlined in each of the sequences above. Reference the Step by number..



Microsoft Excel
Worksheet

2.3 Diagram

For clarification, draw (by hand, by Power Point, by UML diagram) the interactions, identifying the Steps where possible.

3 Auxiliary Issues

3.1 References and contacts

Documents and individuals or organizations used as background to the function described; other functions referenced by this function, or acting as “sub” functions; or other documentation that clarifies the requirements or activities described. All prior work (intellectual property of the company or individual) or proprietary (non-publicly available) work must be so noted.

ID	Title or contact	Reference or contact information
[1]		
[2]		

3.2 Action Item List

As the function is developed, identify issues that still need clarification, resolution, or other notice taken of them. This can act as an Action Item list.

ID	Description	Status
[1]		
[2]		

3.3 Revision History

For reference and tracking purposes, indicate who worked on describing this function, and what aspect they undertook.

No	Date	Author	Description
0.			

Real-Time Pricing (RTP) Top Level

1 Descriptions of Function

All prior work (intellectual property of the company or individual) or proprietary (non-publicly available) work should be so noted.

1.1 Function Name

Name of Function

Real-Time Pricing (RTP) – Top Level

1.2 Function ID

IECSA identification number of the function

C-4

1.3 Brief Description

Describe briefly the scope, objectives, and rationale of the Function.

The purpose of the Real-Time Pricing Enterprise Activity is to implement and manage a full scale distributed computing system that integrates key industry operations and permits customers to plan and modify their load and generation in response to price signals in “real-time” (operational timeframe which can range from seconds to days ahead), received from an Energy Services Provider who acts as an intermediary to the Market Operations. Customers can also provide their forecasted loads and generation into the Market Operations (possibly through the Energy Services Provider (ESP) as an aggregator) as energy schedules and ancillary bids/offers. For operators of the power distribution system, Real-Time Pricing provides a mechanism for potentially significant changes in aggregated load based on sharing cost drivers with the customer in an elective supervisory control scheme.

1.4 Narrative

A complete narrative of the Function from a Domain Expert’s point of view, describing what occurs when, why, how, and under what conditions. This will be a separate document, but will act as the basis for identifying the Steps in Section 2.

A typical day-in-the-life scenario is as follows (note that the discussion is marked up with numbers that are used later in the analysis to derive requirements from the scenario):

In the historical energy supply system, the time-based analysis of customer consumption of energy was cost prohibitive. Yet, the actual cost of providing energy is substantially time and load dependent. The regulated utility was the great averaging factor for these variable costs. Today, modern electronics and communications make it cost effective to apply a more accurate allocation of costs and usages of energy. Real-time pricing is a market mechanism to provide for dynamic feedback control and pricing of energy based on genuine costs.

⁽¹⁾Periodically, the regional transmission operator/independent system operator (Regional System Operator) market operations system (or other market entity, depending upon the market design) forecasts power system conditions for a specific period, say the next 24 hours, based on energy schedules and prices already submitted, ancillary services available, weather conditions, day of the week, scheduled outage information from transmission and distribution operations, and real-time information from transmission and distribution operations, etc.

⁽²⁾From these forecasts, an RTP Calculation function develops tables of load versus price for each “power system node” and for each “settlement” period (e.g. each hour). These tables are the **Base RTP data**. The purpose of this computation is to accurately forecast the cost of providing energy during the period.

⁽³⁾These Base RTP tables are made available to all subscribers of this information (depending upon market rules), typically by being uploaded to a MarketInterfaceServer.

⁽⁴⁾The Energy Services Provider (ESP) obtains the Base RTP data tables from the MarketInterfaceServer, and uses them to develop **Customer-specific RTP rate tables**. These calculations are based on contractual agreements between the ESP and the different types of customers it serves. For example, a large industrial customer that can curtail large loads during peak hours will get a different rate than a small commercial customer with less ability to modify its load. ⁽⁵⁾The ESP sends these Customer-specific RTP rate tables to each of the customers it serves, using different mechanisms: fax, email, or direct data channels (e.g. dial-up telephone or AMR system).

⁽⁶⁾The customer’s Building Automation System (CustomerBuildingAutomationSystem) optimizes its loads and distributed energy resources (DER), based on the customer-specific rate table it receives, the load requirements and constraints, and any DER requirements, capabilities, and constraints. The CustomerBuildingAutomationSystem understands the nature and opportunity for altering consumption based on economic and comfort drivers, and, the physical dynamics of the specific customer premises. ⁽⁷⁾The CustomerBuildingAutomationSystem then issues (or updates existing) schedules and other control mechanisms for loads and for DER generation. These control actions may be automatically implemented or may be reviewed and changed by the customer.

⁽⁸⁾The Customer’s CustomerBuildingAutomationSystem may then send generation schedules to the DER management system for it to implement during each “settlement” period.

⁽⁹⁾The CustomerBuildingAutomationSystem system uses the site-optimized algorithms to forecast its load and DER generation. It also determines what additional ancillary services it could offer, such as increased DER generation or emergency load reduction, and calculates what bid prices to offer these ancillary services at.

⁽¹⁰⁾The CustomerBuildingAutomationSystem then submits these energy schedules and ancillary services bids to the ESP (or Scheduling Coordinator, depending upon market structure), as input to the Regional System Operator market operations.

⁽¹¹⁾The ESP aggregates (or leaves as individual information) the energy schedules and ancillary service bids, and submits them to the market operations. These will affect the next iteration of RTP calculations.

^(12a)As each “settlement” period is reached or during each period as optimal, the CustomerBuildingAutomationSystem issues load control commands to the end devices (setting levels, cycling, turning on/off, etc.). The DER management system controls the DER devices according to the DER schedule.

^(12b)The distribution operations systems monitor any larger DER devices to ensure power quality constraints are met, and to help manage emergency situations (detailed in the Advanced Distribution Automation Use Case). ^(12c)Load and generation deviations, as well as initiation of ancillary services which have been requested by the market operations, are handled according to normal market operations procedures (as detailed in the Market Operations Use Case).

⁽¹³⁾In the post “settlement” period (as shown in the MeterDevice Reading Use Case), customer load and generation meters are read by MeterDataManagementAgent (MDMAs) and passed to the market operations settlement systems (as shown in the Market Operations Use Case). The availability of fine-grained load profile information (for example, measurements integrated for each 15 minute period of consumption during the billing period), allows for accurate application of the agreed upon tariff.

⁽¹⁴⁾ External regulators and auditors review the RTP base and customer-specific tables to ensure compliance with market rules.

A systems and network administrator manages the communications networks, connected equipment (common environment), in addition to any distributed applications within the security domain defined by this domain template. The administrator also manages the life-cycle of all the equipment and distributed computing applications within this domain. The administrator is supported by advanced systems management functions that are designed into intelligent equipment.

1.5 Actor (Stakeholder) Roles

Describe all the people (their job), systems, databases, organizations, and devices involved in or affected by the Function (e.g. operators, system administrators, technicians, end users, service personnel, executives, SCADA system, real-time database, RTO, RTU, Intelligent Electronic Device, power system). Typically, these actors are logically grouped by organization or functional boundaries or just for collaboration purpose of this use case. We need to identify these groupings and their relevant roles and understand the constituency. The same actor could play different roles in different Functions, but only one role in one Function. If the same actor (e.g. the same person) does play multiple roles in one Function, list these different actor-roles as separate rows.

<i>Grouping(Community)</i>	<i>Group Description</i>
Top Level Actors	High-level actors who have significant stake on the RTP Top Level function.

<i>Grouping(Community)</i>		<i>Group Description</i>
<i>Actor Role Name</i>	<i>Actor Type (person, device, system etc.)</i>	<i>Role Description</i>
Regional System Operator	Organization	Organizations responsible for maintaining transmission system reliability and ensuring open access of the grid to all market participants. Regional System Operator responsibilities include: transmission planning, real-time system operation, and market monitoring and management.
Market Timer	Timer	Timer to trigger application execution at specific times of the day, week, month, etc
MarketInterface Server	Server	Stores, manages and secures information flows between Market Operations in utilities and Market Participants
EnergyServiceP rovider	System	Receives the base RTP tables and calculates customer-specific RTP tables
CustomerBuildi ngAutomationS ystem	System	Receives customer-specific RTP values and optimizes load and DER generation. Also submits energy schedules, ancillary services bids/offers, and implements load control in real time.
CustomerLoad	Power equipment	Equipment that will be controlled according to the Load Schedule
Forecast Timer	Timer	Timer to initiate the submittal of Customer load forecasts and ancillary services bids/offers
DERDevice	Power equipment	Equipment that will be managed according to the DER Schedule
DERManagemen tSystem	System	System that implements schedules received from the Customer's EMS or other sources (see DER functions)

<i>Grouping(Community)</i>		<i>Group Description</i>
TransmissionSystemOperator	System	Provides power system configuration and real-time data to market operations
TransmissionSystem	Power equipment	Transmission power system equipment
TransmissionSCADASystem	System	System that provides forecast and real-time transmission information to the market operations system
DistributionManagementSystem	System	Provides real-time data to market operations and monitors (larger) DER devices
DistributionSystem	Power equipment	Distribution power system equipment
SCADASystem	System	System that monitors DER as well as providing forecast and real-time distribution information to the market operations system
MeterDevice	Devices	Collects energy and demand data per time period
CustomerCommunicationPortal	Devices	Enables and Manages communications between Access Networks and In-Building Networks/Equipment
Intelligent End-Use Equipment	Devices	Receives control and/or price signals from Consumer CustomerBuildingAutomationSystem or CustomerCommunicationPortal
MeterDataManagementAgent	Person	Reads customer loads and generation meters

<i>Grouping(Community)</i>		<i>Group Description</i>
Regulators and Auditing Personnel	Person	Review the RTP base and customer-specific tables to ensure compliance with market rules
RTPSystemAdministrator	System	Manages overall RTP environment including network and systems (applications and equipment) management, security policy management and enforcement, and life-cycle management
A/S Services application	Service	Application that manage the ancillary services
RTPBaseCalculator	Service	Application determines the desired load based on power system constraints, operational costs, market conditions, etc. Function then calculates the base RTP table as part of market operations
Customer	Organization	
CustomerBuildingAutomationSystem optimization application	Service	CustomerBuildingAutomationSystem Optimization application optimizes loads and DER generation, based on requirements, constraints, and RTP rates
Distribution monitoring system		
EnergyScheduler		

<i>Grouping(Community)</i>		<i>Group Description</i>
EnergySchedule Database		
RTPCalculator		
Generation bid/offers application		
HistoricLoadForecastDatabase		
MeterDevice		
LoadForecaster		
SettlementSystem		
RTPDatabase		
Transmission monitoring system		
WeatherService		
DERScheduleDatabase		

<i>Grouping(Community)</i>		<i>Group Description</i>
LoadSchedule		
Everyone		
BaseRTPDatabase		
PX rate administrator		

Replicate this table for each logic group.

1.6 Information exchanged

Describe any information exchanged in this template.

<i>Information Object Name</i>	<i>Information Object Description</i>
Energy Schedules	Energy schedules submitted to Market Operations
Aggregated Energy Schedules	Aggregated energy schedules from multiple sources
Base RTP Data Tables	<p>Tables of prices versus loads and times for each power system node, which consist of a matrix of:</p> <ul style="list-style-type: none"> • Nodes • Settlement periods • Loads • Base prices

<i>Information Object Name</i>	<i>Information Object Description</i>
Transmission Outage and Constraint Data	Data containing transmission outage and constraint information
Distribution Outage and Constraint Data	Data containing distribution outage and constraint information
Customer-specific RTP rate tables	Tables of prices versus loads and times for the specific customer
Load Schedule	Schedule for Customer Load equipment: turning on and off, cycling, and/or level of load
DER Schedule	Schedule for DER devices: turning on/off, setting generation levels, setting mode of operation
Customer load forecasts	Forecasts of customer loads
Customer Ancillary Services Bids/Offers	Bids and/or offers for the customer to provide ancillary services to the market
Aggregated CustomerLoad	Aggregated load forecasts from multiple customers
Loads Forecast	Load forecasts, based on different inputs and possible market scenarios
Weather Forecasts	Weather forecasts
Ancillary Services Bids/Offers	Ancillary Services bids and offers submitted to Market Operations
Aggregated Customer A/S Bids/Offers	Aggregated ancillary services bids/offers from multiple customers

<i>Information Object Name</i>	<i>Information Object Description</i>
TransmissionSystem Data	Transmission power system data, including scheduled outages, transmission constraints, and real-time information
DistributionSystem Data	Distribution power system data, including scheduled outages, distribution constraints, and real-time information
Real-time Monitoring and Control Data	Status, settings, deferrable energy requirements, automated on/off commands, automated settings, pricing information (RTP)
DER Data	Status and settings, etc.
Real-time Power Systems Operations Data	Loads, generation, A/S, etc.
Revenue MeterMeterDevice Data	Energy and demand data per time period Including kVa (true rms),
Power Quality Data	PQ Data (premium power)
Device Communications Management Data	Meta data from equipment for configuring of system functions (capabilities, functions, limitations)
Device Management Data	Data for management of remote equipment, including self diagnostics,
Network Management Data	Data for management of access network functions: ISO classifications plus additional as appropriate
Security Management Data	Data necessary for the management of security functions including implementation of security policies across the security domain.

<i>Information Object Name</i>	<i>Information Object Description</i>
Portal Management Data	Data for management and administration of portal technologies; access control, security management

1.7 Activities/Services

Describe or list the activities and services involved in this Function (in the context of this Function). An activity or service can be provided by a computer system, a set of applications, or manual procedures. These activities/services should be described at an appropriate level, with the understanding that sub-activities and services should be described if they are important for operational issues, automation needs, and implementation reasons. Other sub-activities/services could be left for later analysis.

<i>Activity/Service Name</i>	<i>Activities/Services Provided</i>
Load forecast function	Function uses transmission and distribution information, energy schedules, weather, and past history to forecast loads
Weather forecast function	Function uses data to estimate probable weather temperatures, etc.
RTPBaseCalculator function	Function determines the desired load based on power system constraints, operational costs, market conditions, etc. Function then calculates the base RTP table as part of market operations
ESP Specific RTPCalculator	Function that uses the base RTP value to calculate customer-specific RTPs, based on their tariffs
Customer's CustomerBuildingAutomationSystem Optimization function	System that uses the customer-specific RTP table to determine the optimal load schedules and DER generation schedules (if that is available)
Customer CustomerBuildingAutomationSystem forecast customer energy schedules and ancillary services	Function that submits energy schedules and ancillary service bids/offers to market operations

<i>Activity/Service Name</i>	<i>Activities/Services Provided</i>
function	
ESP energy aggregation function	Function that aggregates load information from multiple customers and manages the submittal to the market operations system
ESP ancillary services aggregation function	Function that aggregates ancillary service bids/offers and manages the submittal to the market operations system
Market operations energy services function	Function that captures and analyzes energy schedules to ensure all power system constraints are met
Market operations ancillary services function	Function that captures offers/bids of ancillary services and categorizes them for use during the “settlement” period

1.8 Contracts/Regulations

Identify any overall (human-initiated) contracts, regulations, policies, financial considerations, engineering constraints, pollution constraints, and other environmental quality issues that affect the design and requirements of the Function.

<i>Contract/Regulation</i>	<i>Impact of Contract/Regulation on Function</i>
Utility operations	FERC and state regulators oversee utility operations
Market tariffs Management	Will vary for different market environments and different customer RTP contracts with ESPs
Customer RTP contracts with ESPs	Drives technology and security requirements
Network and Systems Management Policies	Manages network and communications resources including administering service agreements for Quality of Service and management priorities
Security Policy Management	Enforces and enables specific security functions and requirements in all relevant equipment and

<i>Contract/Regulation</i>	<i>Impact of Contract/Regulation on Function</i>
	applications

<i>Policy</i>	<i>From Actor</i>	<i>May</i>	<i>Shall Not</i>	<i>Shall</i>	<i>Description (verb)</i>	<i>To Actor</i>
Pricing info	EnergyServiceProvider or Regional System Operator or PX rate administrator			X	ESP or ISO/RTO or PX rate administrator :Provide pricing information as per the properties contained in the defined customer tariff and ensure priced delivered to customer is correct	Customer
Security and compliance	ENERGYSERVICEPROVIDER or RTPSystemAdministator			X	Meet security requirements and ensure compliance with all critical information in tariffs, laws and policies must be auditable	Customer
Add-ons	ENERGYSERVICEPROVIDER	X			Make add-ons to real-time prices that vary, based on type of customer or tariff	Customer
Technology utilization	ENERGYSERVICEPROVIDER	X			Utilize different methodologies and technologies for providing pricing information, depending upon type and location of customer, market tariffs, customer tariffs, corporate decisions, financial considerations and security policies	Customer
Delivery	ENERGYSERVICEPROVIDER	X			Undertake delivery of RFP data via reasonable variations in implementation approaches through robust system designs	Customer
Data receipt	Customer	X			Decide not to receive the RTP data	ENERGYSERVICEPROVIDER
Sensitive data	Everyone		X		Sensitive information must not be accessible by unauthorized entities and must not be prevented from being accessed by authorized entities	Everyone
Equipment	Everyone		X		Changes that are variations in delivery methods must not require field equipment changeouts	Everyone

<i>Constraint</i>	<i>Type</i>	<i>Description</i>	<i>Applies to</i>
Laws of physics	Environmental	Laws of physics for power system operations	All
Technology	Environmental	Technology constraints for providing real-time pricing information to all customers with RTP as part of their customer tariffs	All
Security	Environmental	Security policies and technologies must be established and used to address all security needs at the appropriate/contracted levels	All

2 Step by Step Analysis of Function

Describe steps that implement the function. If there is more than one set of steps that are relevant, make a copy of the following section grouping (Preconditions and Assumptions, Steps normal sequence, and Steps alternate or exceptional sequence, Post conditions)

2.1 Steps to implement function

Name of this sequence.

2.1.1 Preconditions and Assumptions

Describe conditions that must exist prior to the initiation of the Function, such as prior state of the actors and activities

Identify any assumptions, such as what systems already exist, what contractual relations exist, and what configurations of systems are probably in place

Identify any initial states of information exchanged in the steps in the next section. For example, if a purchase order is exchanged in an activity, its precondition to the activity might be 'filled in but unapproved'.

<i>Actor/System/Information/Contract</i>	<i>Preconditions or Assumptions</i>
Market operations	Market tariffs have been developed and implemented to support real-time pricing
Transmission/distribution operations	Normal power system operations where some customers have contracted to receive and respond to RTP signals
Customer building automation	These customers have Building Automation Systems (CustomerBuildingAutomationSystem) in place to calculate optimal load patterns and DER patterns, based on parameters set by customers and on the RTP values

2.1.2 Steps – Normal Sequence

Describe the normal sequence of events, focusing on steps that identify new types of information or new information exchanges or new interface issues to address. Should the sequence require detailed steps that are also used by other functions, consider creating a new “sub” function, then referring to that “subroutine” in this function. Remember that the focus should be less on the algorithms of the applications and more on the interactions and information flows between “entities”, e.g. people, systems, applications, data bases, etc. There should be a direct link between the narrative and these steps.

The numbering of the sequence steps conveys the order and concurrency and iteration of the steps occur. Using a Dewey Decimal scheme, each level of nested procedure call is separated by a dot ‘.’. Within a level, the sequence number comprises an optional letter and an integer number. The letter specifies a concurrent sequence within the next higher level; all letter sequences are concurrent with other letter sequences. The number specifies the sequencing of messages in a given letter sequence. The absence of a letter is treated as a default ‘main sequence’ in parallel with the lettered sequences.

Sequence 1:

*1.1 - Do step 1
1.2A.1 - In parallel to activity 2 B do step 1
1.2A.2 - In parallel to activity 2 B do step 2
1.2B.1 - In parallel to activity 2 A do step 1
1.2B.2 - In parallel to activity 2 A do step 2
1.3 - Do step 3
1.3.1 - nested step 3.1
1.3.2 - nested step 3.2*

Sequence 2:

*2.1 - Do step 1
2.2 - Do step 2*

#	Event	Primary Actor	Name of Process/Activity	Description of Process/Activity	Information Producer	Information Receiver	Name of Info Exchanged	Additional Notes	IECSA Environments
#	Triggering event? Identify the name of the event. ¹	What other actors are primarily responsible for the Process/Activity? Actors are defined in section 1.5.	Label that would appear in a process diagram. Use action verbs when naming activity.	Describe the actions that take place in active and present tense. The step should be a descriptive noun/verb phrase that portrays an outline summary of the step. "If ...Then...Else" scenarios can be captured as multiple Actions or as separate steps.	What other actors are primarily responsible for Producing the information? Actors are defined in section 1.5.	What other actors are primarily responsible for Receiving the information? Actors are defined in section 1.5. (Note – May leave blank if same as Primary Actor)	Name of the information object. Information objects are defined in section 1.6	Elaborate architectural issues using attached spreadsheet. Use this column to elaborate details that aren't captured in the spreadsheet.	Reference the applicable IECSA Environment containing this data exchange. Only one environment per step.
1.1	Market Timer initiates the forecast of power system conditions	Market Timer	System Forecast	Forecast power system conditions for the next "settlement" periods	EnergyScheduleDatabase A/S Services application TransmissionSCADA System system SCADA System system WeatherService HistoricLoadForecastDatabase	LoadForecaster	Energy schedules, Ancillary services bids/offers, Transmission outage and constraint data, Distribution outage and constraint data, Weather forecasts, Historical forecast data and parameters	- APIs needed between databases and application - Inter utility communications must be supported - Existing weather protocol and weather format must be used	Control Center / Corporations

¹ Note – A triggering event is not necessary if the completion of the prior step – leads to the transition of the following step.

#	Event	Primary Actor	Name of Process/Activity	Description of Process/Activity	Information Producer	Information Receiver	Name of Info Exchanged	Additional Notes	IECSA Environments
1.2	Market Timer initiates the calculation of Base RTP tables	Market Timer	Base RTP Calculation	Calculate a table of RTP values for each "settlement" period and for different loads at different "power system nodes"	LoadForecaster	RTPBaseCalculator	Forecasts of loads and generation at each node	API needed	RTOs / Market Participants
1.3	Market Timer initiates the posting of Base RTP data for ESPs	Market Timer	Base RTP Posting	RTPBaseCalculator posts Base RTP tables on MarketInterfaceServer for ESPs to access/download	RTPBaseCalculator	MarketInterfaceServer	Base RTP data tables	Upload to MarketInterfaceServer	RTOs / Market Participants
1.4	Base RTP table updates become available on MarketInterfaceServer	MarketInterfaceServer	Base RTP Download	RTPCalculator application receives information on Base Real-Time Prices and calculates the customer-specific RTP tables for different categories of customers	MarketInterfaceServer	RTPCalculator	Base RTP data tables	Download from MarketInterfaceServer Security is major concern	RTOs / Market Participants
1.5	ESP calculates customer-specific RTP tables	ENERGYSERVICE PROVIDER	Customer RTP Calculation	ESPs issue customer-specific RTP rate tables to appropriate contracted customers	RTPCalculator	CustomerBuildingAutomationSystem (CustomerBuildingAutomationSystem) optimization application	Customer-specific RTP rate tables which consist of a matrix of: Nodes Settlement periods Loads Customer rates	Multi-cast over WAN from ESP to many customer sites (could be fax, email, telephone, or Internet) Security is a major concern	Customer / ESP
1.6	CustomerBuildingAutomationSystem implements a secure session, receives RTP rate tables and acknowledges	CustomerBuildingAutomationSystem	Customer RTP Receipt	CustomerBuildingAutomationSystem Optimization application optimizes loads and DER generation, based on requirements, constraints, and RTP rates	CustomerBuildingAutomationSystem optimization application	LoadSchedule, DERScheduleDatabase	Load schedule DER generation schedule	DB APIs	DER Monitoring and Control

#	Event	Primary Actor	Name of Process/Activity	Description of Process/Activity	Information Producer	Information Receiver	Name of Info Exchanged	Additional Notes	IECSA Environments
1.7	Customers may review schedules	Customer CustomerBuilding AutomationSystem	Customer RTP Review	Issues schedules for review	Customer CustomerBuilding AutomationSystem optimization application	Customer	LoadSchedule DERScheduleDatab ase	User interface	User Interface
1.8	CustomerBuildingAutomationSystem issues schedules	Customer CustomerBuilding AutomationSystem	Schedule Generation	CustomerBuildingAutomationSystem updates schedules based on any Customer input	Customer CustomerBuilding AutomationSystem optimization application	LoadSchedule, DERScheduleD atabase	LoadSchedule DERScheduleDatab ase	DB API	Intra-Customer Site
1.9	Customer Load Forecast and Ancillary Services bids/offers	Customer CustomerBuilding AutomationSystem	Customer Load Forecast	Calculate and update customer load forecasts and generation bids and/or offers	Forecast timer	Customer load forecast and generation bid/offers application	Customer load forecasts Ancillary services bids and/or offers	DB API	Intra-Customer Site
1.10	Submittal of Load Forecasts and A/S bids/offers	Customer CustomerBuilding AutomationSystem	Load and A/S Bid Submittal	Submit customer load forecasts and ancillary services bids and/or offers to the EPS for aggregation into the market	Customer load forecast and generation bid/offers application	ESP Aggregator applications	Customer load forecasts Ancillary services bids and/or offers	Communication channel between Customers and ESPs, requiring high security	Customer / ESP
1.11	Aggregate loads and A/S	ENERGYSERVIC EPROVIDER	Aggregate Loads	Submit aggregated loads as energy schedules Submit A/S bids and/or offers	ESP Aggregator applications	EnergySchedule r and A/S Services application	Aggregated energy schedules Aggregated A/S bids and/or offers	<i>As in Market Participants interface to Market Operations Use Case</i>	RTOs / Market Participants

#	Event	Primary Actor	Name of Process/Activity	Description of Process/Activity	Information Producer	Information Receiver	Name of Info Exchanged	Additional Notes	IECSA Environments
1.12a	Real-time monitoring and control	Customer Building Automation System	Monitoring and Control	Customer Building Automation System monitors current status, settings, and deferrable energy requirements of loads Based on current and projected future prices, current status of loads, and taking into account the customer needs and priorities, the Customer Building Automation System issues control commands to simple loads or forwards pricing to advanced end-use equipment.	Customer loads, Customer Building Automation System	Customer Building Automation System, Customer loads	Real-time monitoring and control data Status Settings Deferrable energy requirements Automated on/off commands Automated settings Pricing information (RTP)	Monitoring and control of remote end equipment requires high availability and probably is media and/or compute constrained	Lower Security DAC
1.12b	Monitor DER	DER Device	DER Monitoring	Monitor DER devices for power system reliability reasons	DER Device	Distribution monitoring system	DER data	Communications channel between distribution utility and DER location	DER Monitoring and Control
1.12c	Real-time power system operations	T&D Operations System	Power System Operations	Collect data to be used for settlements	Transmission monitoring system and Distribution monitoring system	Settlement System	Real-time power systems operations data Loads Generation A/S	<i>Details in Market Operations Use Case</i>	RTOs / Market Participants
1.13	Loads are metered	Meter Device	Load Metering	Loads are metered per time period, possibly by load as well as whole building	Meter Device	Meter Device Data Management Agent (MDMA)	Meter data Load identity Energy and demand data per time period	<i>Details in Meter Device Reading of electric meters Use Case</i>	Customer / ESP

#	Event	Primary Actor	Name of Process/Activity	Description of Process/Activity	Information Producer	Information Receiver	Name of Info Exchanged	Additional Notes	IECSA Environments
1.14	Auditing	AuditingPersonnel	Auditing	Validate compliance with market rules	BaseRTPDatabase, Customer-RTPDatabase	Regulators, AuditingPersonnel	Base RTP data Customer-specific RTP rate tables	<i>Details in Regulation/Auditing Use Case</i>	Control Center / Corporations

2.1.3 Steps – Alternative / Exception Sequences

Describe any alternative or exception sequences that may be required that deviate from the normal course of activities. Note instructions are found in previous table.

#	Event	Primary Actor	Name of Process/Activity	Description of Process/Activity	Information Producer	Information Receiver	Name of Info Exchanged	Additional Notes	IECSA Environments

2.1.4 Post-conditions and Significant Results

Describe conditions that must exist at the conclusion of the Function. Identify significant items similar to that in the preconditions section.

Describe any significant results from the Function

<i>Actor/Activity</i>	<i>Post-conditions Description and Results</i>
All	On-going, normal operations

2.2 Architectural Issues in Interactions

Elaborate on all architectural issues in each of the steps outlined in each of the sequences above. Reference the Step by number..



Microsoft Excel
Worksheet

2.3 Diagram

For clarification, draw (by hand, by Power Point, by UML diagram) the interactions, identifying the Steps where possible.

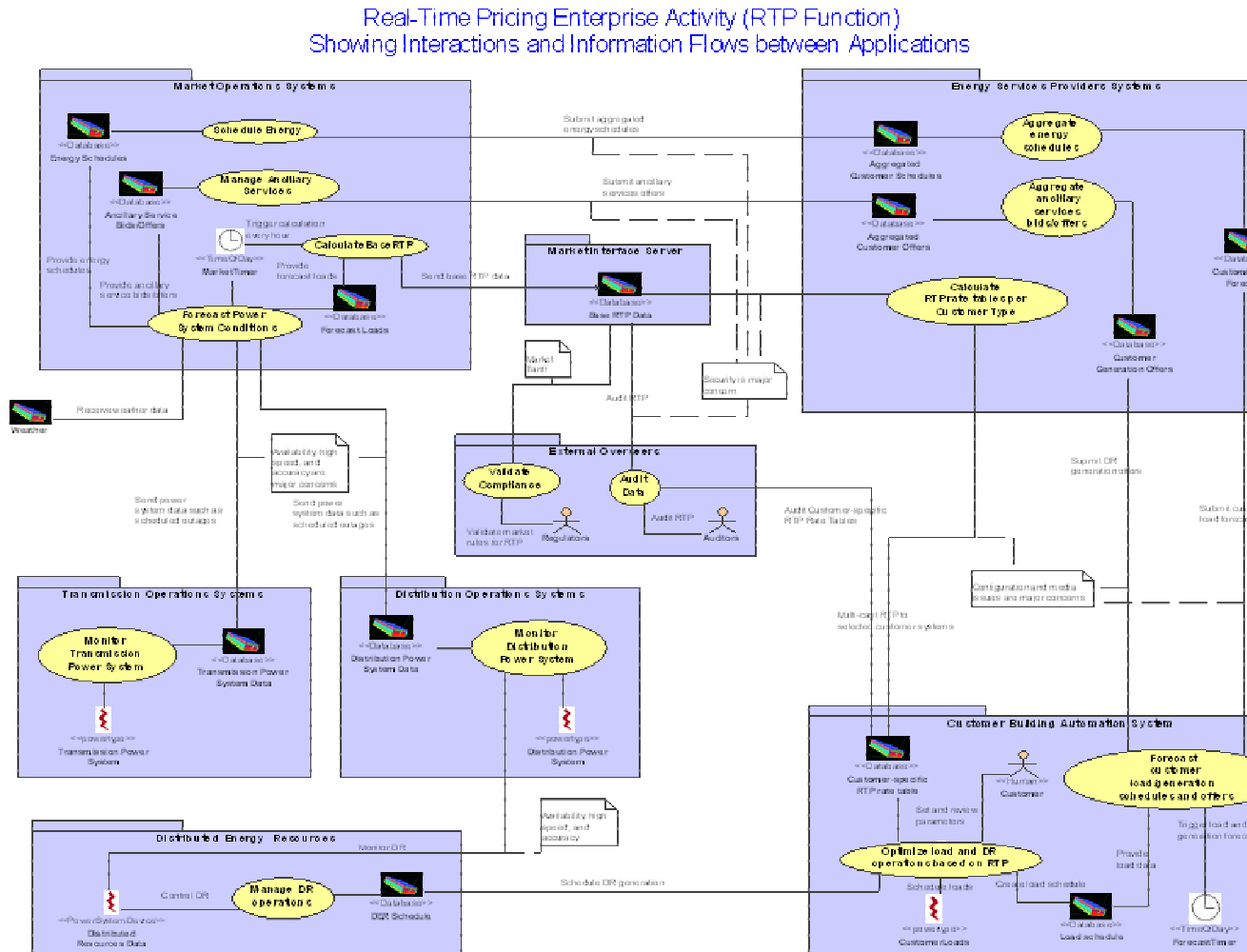

3 Auxiliary Issues

3.1 References and contacts

Documents and individuals or organizations used as background to the function described; other functions referenced by this function, or acting as “sub” functions; or other documentation that clarifies the requirements or activities described. All prior work (intellectual property of the company or individual) or proprietary (non-publicly available) work must be so noted.

ID	Title or contact	Reference or contact information
[1]	General	Market energy schedule submittals, market ancillary services bid/offer submittals, transmission monitoring and control, distribution monitoring and control, advanced distribution automation, management of DER devices, meter reading, and market settlement processes have additional functionality described elsewhere.
[2]	Metering, communications and computing for price-responsive demand programs	Eric Hirst and Brendan Kirby, Electric Light & Power August, 2001
[3]	Donna Pratt	Neenan and Associates

3.2 Action Item List

As the function is developed, identify issues that still need clarification, resolution, or other notice taken of them. This can act as an Action Item list.

ID	Description	Status
[1]	Discuss comment RZ6	Disagreement over comment

[2]		
-----	--	--

3.3 Revision History

For reference and tracking purposes, indicate who worked on describing this function, and what aspect they undertook.

No	Date	Author	Description
1	1/30/2004	Jeff Lamoree	Updated based on team comments

This page intentionally left blank.

RTP – Base RTP Calculation Function

1 Descriptions of Function

All prior work (intellectual property of the company or individual) or proprietary (non-publicly available) work should be so noted.

1.1 Function Name

RTP – Base RTP Calculation Function

1.2 Function ID

IECSA identification number of the function

C-4

1.3 Brief Description

Base RTP Calculation function develops tables of load versus price for each “power system node” and for each “settlement” period (e.g. each hour). These tables are the Base RTP data. The purpose of this computation is to accurately forecast the cost of providing energy during the period.

1.4 Narrative

The RTP Base calculations are performed by the Market Operations actor after the Load Forecast function is complete to calculate the costs of delivering energy to customers during each of the settlement periods (usually 1 hour intervals) in the horizon of the calculations. These calculations are usually performed on a day-ahead basis so the information can be processed, transmitted to ESPs and finally to the RTP customer in time for action. RTP can be calculated or modified on an hourly basis if marginal cost warrant and customers are willing to subscribe and respond to such a service.

The base calculation require from the LoadForecaster as well as costs information from a variety of sources. These costs include the fuel and variable costs associated with the generation unit that will serve incremental load, adjustments for line losses, a risk adders,

and congestion fees. There is concerted effort in the industry to improve the speed and accuracy of the calculations for more timely and accurate pricing.

1.5 Actor (Stakeholder) Roles

Describe all the people (their job), systems, databases, organizations, and devices involved in or affected by the Function (e.g. operators, system administrators, technicians, end users, service personnel, executives, SCADA system, real-time database, RTO, RTU, IED, power system). Typically, these actors are logically grouped by organization or functional boundaries or just for collaboration purpose of this use case. We need to identify these groupings and their relevant roles and understand the constituency. The same actor could play different roles in different Functions, but only one role in one Function. If the same actor (e.g. the same person) does play multiple roles in one Function, list these different actor-roles as separate rows.

<i>Grouping (Community)</i>		<i>Group Description</i>
Market Operators		Forecasts loads, determines optimal loads, and initiates process to determine tables of Base RTP values for the next hours and days
<i>Actor Name</i>	<i>Actor Type (person, device, system etc.)</i>	<i>Actor Description</i>
LoadForecaster	System	Provides the forecast for load across the system for the evaluation period at each node of the system.
RTPBaseCalculator	System	This function
MarginalEnergyCost	Data	Marginal energy costs for system
MarketInterfaceServer	System	Provides access to market information to ESPs and other market participants.

<i>Grouping (Community)</i>		<i>Group Description</i>
Energy Service Providers		Forecasts loads, determines optimal loads, and initiates process to determine tables of Base RTP values for the next hours and days
<i>Actor Name</i>	<i>Actor Type (person, device, system etc.)</i>	<i>Actor Description</i>
RTPCalculator	System	Receives the base RTP calculations and calculates rates for specific RTP customers. See “Customer Specific RTP Calculation” use cases.

1.6 Information exchanged

Describe any information exchanged in this template.

<i>Information Object Name</i>	<i>Information Object Description</i>
Forecasted system loads	System load predictions for the intervals covered by the RTP rate calculations.
MarginalEnergyCost	Table of marginal energy costs for the power system.
Base RTP rates table	Table of costs to deliver energy to pre-defined nodes throughout the power system for intervals in the RTP calculations.

1.7 Activities/Services

Describe or list the activities and services involved in this Function (in the context of this Function). An activity or service can be provided by a computer system, a set of applications, or manual procedures. These activities/services should be described at an appropriate level, with the understanding that sub-activities and services should be described if they are important for operational issues, automation needs, and implementation reasons. Other sub-activities/services could be left for later analysis.

<i>Activity/Service Name</i>	<i>Activities/Services Provided</i>
Load Forecasting	Provides the accurate estimates of load at various points throughout the system in the settlement intervals for the period of the RTP schedule. This function is described in detail in separate use cases.
RTPCalculator	Calculates customer specific RTP rates for current and future rate intervals. This service is described in detail in a separate use cases.

1.8 Contracts/Regulations

Identify any overall (human-initiated) contracts, regulations, policies, financial considerations, engineering constraints, pollution constraints, and other environmental quality issues that affect the design and requirements of the Function.

<i>Contract/Regulation</i>	<i>Impact of Contract/Regulation on Function</i>
RTP Tariffs	Dictates the conditions and limits and tariff of the RTP contract that can be entered with customer.
RTP Contract	Dictates the price and response windows that will be applied to the Customer's energy usage
Market Rules	Dictates the rules and procedures for bidding into the Energy and Ancillary Services markets

<i>Policy</i>	<i>From Actor</i>	<i>May</i>	<i>Shall Not</i>	<i>Shall</i>	<i>Description (verb)</i>	<i>To Actor</i>
Provide RTP Base Rates	MarketInterfaceServer			X	Provide regular and continuous RTP base rates for ESP to calculate RTP customer rates	RTPCalculator

<i>Constraint</i>	<i>Type</i>	<i>Description</i>	<i>Applies to</i>
Laws of physics		Laws of physics for power system operations	All
Technology		Technology constraints for providing real-time pricing information to all customers with RTP as part of their customer tariffs	All
Security		Security policies and technologies must be established and used to address all security needs at the appropriate/contracted levels	All

2 Step by Step Analysis of Function

Describe steps that implement the function. If there is more than one set of steps that are relevant, make a copy of the following section grouping (Preconditions and Assumptions, Steps normal sequence, and Steps alternate or exceptional sequence, Post conditions)

2.1 Steps to implement function

Name of this sequence.

2.1.1 Preconditions and Assumptions

Describe conditions that must exist prior to the initiation of the Function, such as prior state of the actors and activities

Identify any assumptions, such as what systems already exist, what contractual relations exist, and what configurations of systems are probably in place

Identify any initial states of information exchanged in the steps in the next section. For example, if a purchase order is exchanged in an activity, its precondition to the activity might be 'filled in but unapproved'.

<i>Actor/System/Information/Contract</i>	<i>Preconditions or Assumptions</i>
Market Operations	Has calculated load forecast and marginal energy prices.

2.1.2 Steps – Normal Sequence

Describe the normal sequence of events, focusing on steps that identify new types of information or new information exchanges or new interface issues to address. Should the sequence require detailed steps that are also used by other functions, consider creating a new “sub” function, then referring to that “subroutine” in this function. Remember that the focus should be less on the algorithms of the applications and more on the interactions and information flows between “entities”, e.g. people, systems, applications, data bases, etc. There should be a direct link between the narrative and these steps.

The numbering of the sequence steps conveys the order and concurrency and iteration of the steps occur. Using a Dewey Decimal scheme, each level of nested procedure call is separated by a dot ‘.’. Within a level, the sequence number comprises an optional letter and an integer number. The letter specifies a concurrent sequence within the next higher level; all letter sequences are concurrent with other letter sequences. The number specifies the sequencing of messages in a given letter sequence. The absence of a letter is treated as a default ‘main sequence’ in parallel with the lettered sequences.

Sequence 1:

*1.1 - Do step 1
1.2A.1 - In parallel to activity 2 B do step 1
1.2A.2 - In parallel to activity 2 B do step 2
1.2B.1 - In parallel to activity 2 A do step 1
1.2B.2 - In parallel to activity 2 A do step 2
1.3 - Do step 3
1.3.1 - nested step 3.1
1.3.2 - nested step 3.2*

Sequence 2:

*2.1 - Do step 1
2.2 - Do step 2*

#	Event	Primary Actor	Name of Process/Activity	Description of Process/Activity	Information Producer	Information Receiver	Name of Info Exchanged	Additional Notes	IECSA Environments
#	<i>Triggering event? Identify the name of the event.¹</i>	<i>What other actors are primarily responsible for the Process/Activity? Actors are defined in section0.</i>	<i>Label that would appear in a process diagram. Use action verbs when naming activity.</i>	<i>Describe the actions that take place in active and present tense. The step should be a descriptive noun/verb phrase that portrays an outline summary of the step. "If ...Then...Else" scenarios can be captured as multiple Actions or as separate steps.</i>	<i>What other actors are primarily responsible for Producing the information? Actors are defined in section0.</i>	<i>What other actors are primarily responsible for Receiving the information? Actors are defined in section0. (Note – May leave blank if same as Primary Actor)</i>	<i>Name of the information object. Information objects are defined in section 1.6</i>	<i>Elaborate architectural issues using attached spreadsheet. Use this column to elaborate details that aren't captured in the spreadsheet.</i>	<i>Reference the applicable IECSA Environment containing this data exchange. Only one environment per step.</i>
1.1	Market Timer initiates the calculation of Base RTP tables	LoadForecaster	Base RTP Calculator	Calculate a table of RTP values for each "settlement" period and for different loads at different "power system nodes"	LoadForecaster	RTPBaseCalculator	Load Forecast and marginal energy costs		RTOs / Market Participants
1.2	Market Timer initiates the posting of Base RTP data for ESPs	Base RTP Calculator	MarketInterfaceServer	Base RTP Calculator posts Base RTP tables on MarketInterfaceServer for ESPs to access/download	RTPBaseCalculator	MarketInterfaceServer	Base RTP rates table		Control Centers / ESPs
1.3	Timer initiates ESP RTP Calculations	RTPCalculator	ESP Customer RTP rate calculations	ESP RTP system polls market interface server for updates to RTP base calculations. If new data is available, it is downloaded and ESP Customer Rate Calculatons	MarketInterfaceServer	RTPCalculator	Base RTP rates table		Control Centers / ESPs

¹ Note – A triggering event is not necessary if the completion of the prior step – leads to the transition of the following step.

2.1.3 Steps – Alternative / Exception Sequences

Describe any alternative or exception sequences that may be required that deviate from the normal course of activities. Note instructions are found in previous table.

#	Event	Primary Actor	Name of Process/Activity	Description of Process/Activity	Information Producer	Information Receiver	Name of Info Exchanged	Additional Notes	IECSA Environments
---	-------	---------------	--------------------------	---------------------------------	----------------------	----------------------	------------------------	------------------	--------------------

2.1.4 Post-conditions and Significant Results

Describe conditions that must exist at the conclusion of the Function. Identify significant items similar to that in the preconditions section.

Describe any significant results from the Function

<i>Actor/Activity</i>	<i>Post-conditions Description and Results</i>
Market Operations	Calculated and made available the current RTP base rates.

2.2 Architectural Issues in Interactions

Elaborate on all architectural issues in each of the steps outlined in each of the sequences above. Reference the Step by number. Double click on the embedded excel file – record the changes and save the excel file (this updates the embedded attachment).



Microsoft Excel
Worksheet

2.3 Diagram

For clarification, draw (by hand, by Power Point, by UML diagram) the interactions, identifying the Steps where possible.

3 Auxiliary Issues

3.1 References and contacts

Documents and individuals or organizations used as background to the function described; other functions referenced by this function, or acting as “sub” functions; or other documentation that clarifies the requirements or activities described. All prior work (intellectual property of the company or individual) or proprietary (non-publicly available) work must be so noted.

ID	Title or contact	Reference or contact information
[1]		
[2]		

3.2 Action Item List

As the function is developed, identify issues that still need clarification, resolution, or other notice taken of them. This can act as an Action Item list.

ID	Description	Status
[1]		
[2]		

3.3 Revision History

For reference and tracking purposes, indicate who worked on describing this function, and what aspect they undertook.

No	Date	Author	Description
1.0	1/19/04	Jack King	Converted from old template, completed architectural interactions.

This page intentionally left blank.

RTP – Customer’s BAS Optimization

1 Descriptions of Function

All prior work (intellectual property of the company or individual) or proprietary (non-publicly available) work should be so noted.

1.1 Function Name

Customer’s BAS Optimization

1.2 Function ID

IECSA identification number of the function

C-4,C-6,C-6.4

1.3 Brief Description

The RTP system provides the RTP schedule through email, pager, bulletin board or direct transfer. The RTP operator at for the customer must enter the schedule into the building automation software (BAS) and perform the necessary optimization activities to implement the RTP goals. Note that EMS or Energy Management System is often used interchangeably with BAS.

1.4 Narrative

The Energy Services Provider (EnergyServiceProvider) obtains the Base RTP data tables from the Market Interface Server, and uses them to develop Customer-specific RTP rate tables. These calculations are based on contractual agreements between the EnergyServiceProvider and the different types of customers it serves. For example, a large industrial customer that can curtail large loads during peak hours will get a different rate than a small commercial customer with less ability to modify its load. The EnergyServiceProvider sends these Customer-specific RTP rate tables to each of the customers it serves, using different mechanisms: fax, email, or direct data channels (e.g. dial-up telephone or AMR system).

The customer’s Building Automation System (BAS) optimizes its loads and distributed energy resources (DER), based on the customer-specific rate table it receives, the load requirements and constraints, and any DER requirements, capabilities, and

constraints. The BAS understands the nature and opportunity for altering consumption based on economic and comfort drivers, and, the physical dynamics of the specific customer premises. The BAS then issues (or updates existing) schedules and other control mechanisms for loads and for DER generation. These control actions may be automatically implemented or may be reviewed and changed by the customer. The Customer’s BAS may then send generation schedules to the DER management system for it to implement during each “settlement” period. Note that the BAS may be a human as apposed to a software system.

The BAS system uses the site-optimized algorithms to forecast its load and DER generation. It also determines what additional ancillary services it could offer, such as increased DER generation or emergency load reduction, and calculates what bid prices to offer these ancillary services at. The BAS then submits these energy schedules and ancillary services bids to the EnergyServiceProvider (or SchedulingCoordinator, depending upon market structure), as input to the RTO/ISO market operations.

1.5 Actor (Stakeholder) Roles

Describe all the people (their job), systems, databases, organizations, and devices involved in or affected by the Function (e.g. operators, system administrators, technicians, end users, service personnel, executives, SCADA system, real-time database, RTO, RTU, Intelligent Electronic Device, power system). Typically, these actors are logically grouped by organization or functional boundaries or just for collaboration purpose of this use case. We need to identify these groupings and their relevant roles and understand the constituency. The same actor could play different roles in different Functions, but only one role in one Function. If the same actor (e.g. the same person) does play multiple roles in one Function, list these different actor-roles as separate rows.

<i>Grouping (Community)'</i>		<i>Group Description</i>
Energy Service Provider (EnergyServiceProvider)		Sells energy and energy services to the customer
<i>Actor Name</i>	<i>Actor Type (person, device, system etc.)</i>	<i>Actor Description</i>
RTPCalculator	System	Calculates customer specific RTP rates for current and future rate intervals. This actor is subject of a separate use case.
SchedulingCoordinator	System	Receives energy schedule and ancillary bids from customers BAS/EMS and forwards to RTO/ISO for input to market operations

<i>Grouping (Community)</i>		<i>Group Description</i>
Energy Service Provider (EnergyServiceProvider)		Sells energy and energy services to the customer
<i>Actor Name</i>	<i>Actor Type (person, device, system etc.)</i>	<i>Actor Description</i>
EnergyServiceProvider	System	Sells energy and energy services to the customer -- actor

<i>Grouping (Community)</i>		<i>Group Description</i>
RTP Subscribing Customer		End use customers who subscribe to RTP rates and have load control capability, either automatic or manual.
<i>Actor Name</i>	<i>Actor Type (person, device, system etc.)</i>	<i>Actor Description</i>
Customer	Person	Receives the RTP signals and inputs those signals into the BAS, validates BAS optimization, bids proposals and actions.
CustomerBuildingAutomationSystem	System	Building Control System, Either a digital system or the Customer manually implements.

1.6 Information exchanged

Describe any information exchanged in this template.

<i>Information Object Name</i>	<i>Information Object Description</i>
RTP rates	Customer Day-Ahead or Hour-Ahead Real-Time Prices
Load deferment and DER schedules	Optimized load and DER schedule from the CustomerBuildingAutomationSystem
Energy / ancillary services bids	Customer bids into the Energy and/or Ancillary Services Market

1.7 Activities/Services

Describe or list the activities and services involved in this Function (in the context of this Function). An activity or service can be provided by a computer system, a set of applications, or manual procedures. These activities/services should be described at an appropriate level, with the understanding that sub-activities and services should be described if they are important for operational issues, automation needs, and implementation reasons. Other sub-activities/services could be left for later analysis.

<i>Activity/Service Name</i>	<i>Activities/Services Provided</i>
RTPCalculator	Calculates customer specific RTP rates for current and future rate intervals. This activity is described in detail in a separate template.
Customer CustomerBuildingAutomationSystem	Calculates the optimum combination of load reductions, deferrals and generation to meet the objective of the customer and RTP contracts and signals.

1.8 Contracts/Regulations

Identify any overall (human-initiated) contracts, regulations, policies, financial considerations, engineering constraints, pollution constraints, and other environmental quality issues that affect the design and requirements of the Function.

<i>Contract/Regulation</i>	<i>Impact of Contract/Regulation on Function</i>
RTP Tariffs	Dictates the conditions and limits and tariff of the RTP contract that can be entered with customer.

<i>Contract/Regulation</i>	<i>Impact of Contract/Regulation on Function</i>
RTP Contract	Dictates the price and response windows that will be applied to the Customer's energy usage
Market Rules	Dictates the rules and procedures for bidding into the Energy and Ancillary Services markets

<i>Policy</i>	<i>From Actor</i>	<i>May</i>	<i>Shall Not</i>	<i>Shall</i>	<i>Description (verb)</i>	<i>To Actor</i>
ProvideEnergy	EnergyServiceProvider			X	Provide power on demand	Customer
Adjust load schedule	Customer	X			Reduce or adjust load schedule to optimize energy costs given RPT for the interval.	EnergyServiceProvider
Energy / ancillary services bids	Customer	X			Bid Energy or ancillary services into the market	EnergyServiceProvider or market operator

<i>Constraint</i>	<i>Type</i>	<i>Description</i>	<i>Applies to</i>
Laws of physics		Laws of physics for power system operations	All
Technology		Technology constraints for providing real-time pricing information to all customers with RTP as part of their customer tariffs	All
Security		Security policies and technologies must be established and used to address all security needs at the appropriate/contracted levels	All

2 Step by Step Analysis of Function

Describe steps that implement the function. If there is more than one set of steps that are relevant, make a copy of the following section grouping (Preconditions and Assumptions, Steps normal sequence, and Steps alternate or exceptional sequence, Post conditions)

2.1 Steps to implement function

Name of this sequence.

2.1.1 Preconditions and Assumptions

Describe conditions that must exist prior to the initiation of the Function, such as prior state of the actors and activities

Identify any assumptions, such as what systems already exist, what contractual relations exist, and what configurations of systems are probably in place

Identify any initial states of information exchanged in the steps in the next section. For example, if a purchase order is exchanged in an activity, its precondition to the activity might be 'filled in but unapproved'.

<i>Actor/System/Information/Contract</i>	<i>Preconditions or Assumptions</i>
RTP contract	RTP contract is in place between EnergyServiceProvider and customer.
Base RTP tables	Base RTP tables have been calculated and transmitted to EnergyServiceProvider for customer specific RTP rates based on contract.
Customer	Has procedures and/or systems in place to implement load optimizations based on RTP signals sent from EnergyServiceProvider.

2.1.2 Steps – Normal Sequence

Describe the normal sequence of events, focusing on steps that identify new types of information or new information exchanges or new interface issues to address. Should the sequence require detailed steps that are also used by other functions, consider creating a new “sub” function, then referring to that “subroutine” in this function. Remember that the focus should be less on the algorithms of the applications and more on the interactions and information flows between “entities”, e.g. people, systems, applications, data bases, etc. There should be a direct link between the narrative and these steps.

The numbering of the sequence steps conveys the order and concurrency and iteration of the steps occur. Using a Dewey Decimal scheme, each level of nested procedure call is separated by a dot ‘.’. Within a level, the sequence number comprises an optional letter and an integer number. The letter specifies a concurrent sequence within the next higher level; all letter sequences are concurrent with other letter sequences. The number specifies the sequencing of messages in a given letter sequence. The absence of a letter is treated as a default 'main sequence' in parallel with the lettered sequences.

Sequence 1:

*1.1 - Do step 1
1.2A.1 - In parallel to activity 2 B do step 1
1.2A.2 - In parallel to activity 2 B do step 2
1.2B.1 - In parallel to activity 2 A do step 1
1.2B.2 - In parallel to activity 2 A do step 2
1.3 - Do step 3
1.3.1 - nested step 3.1
1.3.2 - nested step 3.2*

Sequence 2:

*2.1 - Do step 1
2.2 - Do step 2*

#	Event	Primary Actor	Name of Process/Activity	Description of Process/Activity	Information Producer	Information Receiver	Name of Info Exchanged	Additional Notes	IECSA Environments
#	<i>Triggering event? Identify the name of the event.¹</i>	<i>What other actors are primarily responsible for the Process/Activity? Actors are defined in section 0.</i>	<i>Label that would appear in a process diagram. Use action verbs when naming activity.</i>	<i>Describe the actions that take place in active and present tense. The step should be a descriptive noun/verb phrase that portrays an outline summary of the step. "If ...Then...Else" scenarios can be captured as multiple Actions or as separate steps.</i>	<i>What other actors are primarily responsible for Producing the information? Actors are defined in section 0.</i>	<i>What other actors are primarily responsible for Receiving the information? Actors are defined in section 0. (Note – May leave blank if same as Primary Actor)</i>	<i>Name of the information object. Information objects are defined in section 1.6</i>	<i>Elaborate architectural issues using attached spreadsheet. Use this column to elaborate details that aren't captured in the spreadsheet.</i>	<i>Reference the applicable IECSA Environment containing this data exchange. Only one environment per step.</i>
1.1	Timer or Notification of new rates available	Customer	Customer processes RTP schedule	The customer receives and processes the RTP schedule for the next period. This could be by accessing a web page or reading email.	EnergyService eProvider	Customer	RTP rates		Customer / ESP
1.2	Receipt of new rates	Customer	Customer Enters data into BAS	The customer enters the RTP schedule for the next period into the BAS.	Customer	CustomerBuildingAutomationSystem	RTP rates		Intra-Customer Site
1.3 A.1	Entry of new rates	CustomerBuildingAutomationSystem	Load Optimizations based on RTP	CustomerBuildingAutomationSystem optimizes projected loads, deferrable load and DER based on requirements, constraints and RTP rates.	CustomerBuildingAutomationSystem	Customer	Load deferment and DER schedules		Intra-Customer Site

¹ Note – A triggering event is not necessary if the completion of the prior step – leads to the transition of the following step.

#	Event	Primary Actor	Name of Process/Activity	Description of Process/Activity	Information Producer	Information Receiver	Name of Info Exchanged	Additional Notes	IECSA Environments
1.3 A.2	BAS optimizations complete	Customer	Customer Review of BAS optimizations	Customer reviews the load schedule and approves based on external criteria	Customer	Customer	Load deferment and DER schedules		Intra-Customer Site
1.3 A.3	Load deferment and DER schedules approved	Customer	Implement Load and DER schedules	The customer now implements the approved load and der schedules either manually or enabling the schedule in the BAS.	Customer		Load deferment and DER schedules		Intra-Customer Site
1.3 B.1		CustomerBuildingAutomationSystem	Energy / ancillary services bids	Customer BAS evaluates bids into energy and ancillary services.	CustomerBuildingAutomationSystem	Customer	Energy / ancillary services bids		Intra-Customer Site
1.3 B.2	BAS optimizations complete	Customer	Customer review of energy and ancillary services bids	Customer reviews the proposed bids into energy and ancillary services markets, verifying availability and bid data.	Customer	Customer	Energy / ancillary services bids		Intra-Customer Site
1.3 B.3	Review of energy and ancillary services bid	Customer	Transmit Bids to EnergyServiceProvider	Customer, having approved the energy and or ancillary bids, transmits those bids to the EnergyServiceProvider or market operator	Customer	EnergyServiceProvider	Energy / ancillary services bids		Customer / ESP

2.1.3 Steps – Alternative / Exception Sequences

Describe any alternative or exception sequences that may be required that deviate from the normal course of activities. Note instructions are found in previous table.

#	Event	Primary Actor	Name of Process/Activity	Description of Process/Activity	Information Producer	Information Receiver	Name of Info Exchanged	Additional Notes	IECSA Environments

2.1.4 Post-conditions and Significant Results

Describe conditions that must exist at the conclusion of the Function. Identify significant items similar to that in the preconditions section.

Describe any significant results from the Function

<i>Actor/Activity</i>	<i>Post-conditions Description and Results</i>
Load and DER schedules	Schedules for load and DER for the RTP period are approved and implemented
Energy / ancillary services bids	Bids are transmitted to the EnergyServiceProvider or market operator. These bids are not accepted at this point. A separate use case for acceptance and implementation can be found elsewhere.

2.2 Architectural Issues in Interactions

Elaborate on all architectural issues in each of the steps outlined in each of the sequences above. Reference the Step by number.



Microsoft Excel
Worksheet

2.3 Diagram

For clarification, draw (by hand, by Power Point, by UML diagram) the interactions, identifying the Steps where possible.

3 Auxiliary Issues

3.1 References and contacts

Documents and individuals or organizations used as background to the function described; other functions referenced by this function, or acting as “sub” functions; or other documentation that clarifies the requirements or activities described. All prior work (intellectual property of the company or individual) or proprietary (non-publicly available) work must be so noted.

ID	Title or contact	Reference or contact information
[1]		
[2]		

3.2 Action Item List

As the function is developed, identify issues that still need clarification, resolution, or other notice taken of them. This can act as an Action Item list.

ID	Description	Status
[1]		
[2]		

3.3 Revision History

For reference and tracking purposes, indicate who worked on describing this function, and what aspect they undertook.

No	Date	Author	Description
0.	12/17/2003	Jack King	Transferred from old template.
0.9	2/27/2004	Jack King	Updated based on comments, completed issues spreadsheet

RTP- DERDevice Management

1 Descriptions of Function

All prior work (intellectual property of the company or individual) or proprietary (non-publicly available) work should be so noted.

1.1 Function Name

DERDevice Management

1.2 Function ID

IECSA identification number of the function

C-4, C-6.4

1.3 Brief Description

Describe briefly the scope, objectives, and rationale of the Function.

1.4 Narrative

The DERDevice management system controls the DERDevice(s) according to the DERDevice schedule. The customer's CustomerBuildingAutomationSystem receives the RTP signals from the EnergyServiceProvider and performs optimizations on the best mix of load reductions and DERDevice function based on the customer's criteria. At the beginning of each interval, the CustomerBuildingAutomationSystem sends the appropriate commands to the DERDeviceManager to initiate the DERDevice functions for that interval. The DERDeviceManger processes those commands, initiates the DERDevice utilization and monitors the DERDevice(s) for compliance with commands. Any failure to produce the scheduled DERDevice results in an alarm broadcasted to the CustomerBuildingAutomationSystem where the customer can take appropriate action. The monitored DERDevice activity is made available in real-time to the CustomerBuildingAutomationSystem where the data can be made available to the customer and EnergyServiceProvider.

In addition to RTP responses, the CustomerBuildingAutomationSystem may bid into the energy and ancillary services markets if all business constraints are first met. If these bids are accepted, additional commands may be set to the DERDevice management system to implement those bids. The CustomerBuildingAutomationSystem will monitor the response to insure the bid services are supplied.

The EnergyServiceProvider is responsible for monitoring DERDevice facilities while operating to ensure power quality constraints are met, and to help manage emergency situations (detailed in the Advanced Distribution Automation Use Cases).

1.5 Actor (Stakeholder) Roles

Describe all the people (their job), systems, databases, organizations, and devices involved in or affected by the Function (e.g. operators, system administrators, technicians, end users, service personnel, executives, SCADA system, real-time database, RTO, RTU, IED, power system). Typically, these actors are logically grouped by organization or functional boundaries or just for collaboration purpose of this use case. We need to identify these groupings and their relevant roles and understand the constituency. The same actor could play different roles in different Functions, but only one role in one Function. If the same actor (e.g. the same person) does play multiple roles in one Function, list these different actor-roles as separate rows.

<i>Grouping (Community)</i>		<i>Group Description</i>
RTP Subscribing Customer		End use customers who subscribe to RTP rates and have load control capability, either automatic or manual
<i>Actor Name</i>	<i>Actor Type (person, device, system etc.)</i>	<i>Actor Description</i>
Customer	Person	Verifies activities of the DERDevice Manager and takes action in case of failure
CustomerBuildingAutomationSystem	System	Provides optimized load reductions and DERDevice schedules, notifies DERDevice manager of those schedules and monitors DERDevice systems for compliance with schedule. Interacts with the EnergyServiceProvider to provide real-time information on load and ancillary services performance of customer.
DERDevice	System	Monitors operations schedules, status and controls operation of DERDevice

<i>Grouping (Community)</i>		<i>Group Description</i>
RTP Subscribing Customer		End use customers who subscribe to RTP rates and have load control capability, either automatic or manual
<i>Actor Name</i>	<i>Actor Type (person, device, system etc.)</i>	<i>Actor Description</i>
Manager		equipment under the control of the customer and/or the customer's CustomerBuildingAutomationSystem.
DERDevice Equipment	Device	Equipment controlled by DERDevice Manager. Could include generation and load devices.

<i>Grouping (Community)</i>		<i>Group Description</i>
Energy Service Provider (EnergyServiceProvider)		Sells energy and energy services to the customer
<i>Actor Name</i>	<i>Actor Type (person, device, system etc.)</i>	<i>Actor Description</i>
DERDevice and Ancillary Services Monitoring	System	Monitors RTP customer's system for actual status of ancillary services bid for DERDevice. See Advanced Distribution Automation.
Interval meters/AMR	System	Records energy usage and generation during the settlement periods and sends that information to market operations for financial settlement.
EnergyServiceP rovider		

Replicate this table for each logic group.

1.6 Information exchanged

Describe any information exchanged in this template.

<i>Information Object Name</i>	<i>Information Object Description</i>
DERDevice Schedule	A table of operating levels for DERDevice for each interval in the settlement period. This may be sent one interval at a time or as an entire settlement period's schedule.
DERDevice Device Start/Stop/Set Commands	
DERDevice Status Information	Real-time status of operating DERDevice units
Interval Meter Data	A table of energy consumed by the customer for each interval (maybe sub-interval) in the settlement period. The settlement interval maybe one hour but the energy data may be available on a 5 or 15 minute interval. Full granularity shall be maintained.
Ancillary Services Monitoring Data	Data indicating the ancillary services that are delivered to the system by the customer. This could include VAR support, spinning reserve or load regulation among others.

1.7 Activities/Services

Describe or list the activities and services involved in this Function (in the context of this Function). An activity or service can be provided by a computer system, a set of applications, or manual procedures. These activities/services should be described at an appropriate level, with the understanding that sub-activities and services should be described if they are important for operational issues, automation needs, and implementation reasons. Other sub-activities/services could be left for later analysis.

<i>Activity/Service Name</i>	<i>Activities/Services Provided</i>

<i>Activity/Service Name</i>	<i>Activities/Services Provided</i>

1.8 Contracts/Regulations

Identify any overall (human-initiated) contracts, regulations, policies, financial considerations, engineering constraints, pollution constraints, and other environmental quality issues that affect the design and requirements of the Function.

<i>Contract/Regulation</i>	<i>Impact of Contract/Regulation on Function</i>
Environmental	Maximum run times of DG units may be affected by emissions limits.

<i>Policy</i>	<i>From Actor</i>	<i>May</i>	<i>Shall Not</i>	<i>Shall</i>	<i>Description (verb)</i>	<i>To Actor</i>
Provide DERDevice	Customer			X	Provide power as bid to and excepted by EnergyServiceProvider/marker operations	EnergyServiceProvider
Provide Ancillary Services	Customer			X	Provide Ancillary services as bid to and excepted by EnergyServiceProvider/market operations	EnergyServiceProvider
Meter Energy	EnergyServiceProvider			X	Meter energy delivered to customer	Customer

<i>Constraint</i>	<i>Type</i>	<i>Description</i>	<i>Applies to</i>

2 Step by Step Analysis of Function

Describe steps that implement the function. If there is more than one set of steps that are relevant, make a copy of the following section grouping (Preconditions and Assumptions, Steps normal sequence, and Steps alternate or exceptional sequence, Post conditions)

2.1 Steps to implement function

Name of this sequence.

2.1.1 Preconditions and Assumptions

Describe conditions that must exist prior to the initiation of the Function, such as prior state of the actors and activities

Identify any assumptions, such as what systems already exist, what contractual relations exist, and what configurations of systems are probably in place

Identify any initial states of information exchanged in the steps in the next section. For example, if a purchase order is exchanged in an activity, its precondition to the activity might be 'filled in but unapproved'.

<i>Actor/System/Information/Contract</i>	<i>Preconditions or Assumptions</i>
CustomerBuildingAutomationSystem Optimization	Customer CustomerBuildingAutomationSystem has optimized load and DERDevice based upon RTP schedules as well as DERDevice and ancillary services bids. Secondary optimization may have taken place based on acceptance or decline of DERDevice and ancillary services bids.
DERDevice bid	Bids to provide additional energy into the markets have been accepted.
Ancillary Services bid	Bids to provide ancillary services into the markets have been accepted.

2.1.2 Steps – Normal Sequence

Describe the normal sequence of events, focusing on steps that identify new types of information or new information exchanges or new interface issues to address. Should the sequence require detailed steps that are also used by other functions, consider creating a new “sub” function, then referring to that “subroutine” in this function. Remember that the focus should be less on the algorithms of the applications and more on the interactions and information flows between “entities”, e.g. people, systems, applications, data bases, etc. There should be a direct link between the narrative and these steps.

The numbering of the sequence steps conveys the order and concurrency and iteration of the steps occur. Using a Dewey Decimal scheme, each level of nested procedure call is separated by a dot ‘.’. Within a level, the sequence number comprises an optional letter and an integer number. The letter specifies a concurrent sequence within the next higher level; all letter sequences are concurrent with other letter sequences. The number specifies the sequencing of messages in a given letter sequence. The absence of a letter is treated as a default ‘main sequence’ in parallel with the lettered sequences.

Sequence 1:

*1.1 - Do step 1
1.2A.1 - In parallel to activity 2 B do step 1
1.2A.2 - In parallel to activity 2 B do step 2
1.2B.1 - In parallel to activity 2 A do step 1
1.2B.2 - In parallel to activity 2 A do step 2
1.3 - Do step 3
1.3.1 - nested step 3.1
1.3.2 - nested step 3.2*

Sequence 2:

*2.1 - Do step 1
2.2 - Do step 2*

#	Event	Primary Actor	Name of Process/Activity	Description of Process/Activity	Information Producer	Information Receiver	Name of Info Exchanged	Additional Notes	IECSA Environments
#	<i>Triggering event? Identify the name of the event.¹</i>	<i>What other actors are primarily responsible for the Process/Activity? Actors are defined in section 0.</i>	<i>Label that would appear in a process diagram. Use action verbs when naming activity.</i>	<i>Describe the actions that take place in active and present tense. The step should be a descriptive noun/verb phrase that portrays an outline summary of the step. "If ...Then...Else" scenarios can be captured as multiple Actions or as separate steps.</i>	<i>What other actors are primarily responsible for Producing the information? Actors are defined in section 0.</i>	<i>What other actors are primarily responsible for Receiving the information? Actors are defined in section 0. (Note – May leave blank if same as Primary Actor)</i>	<i>Name of the information object. Information objects are defined in section 1.6</i>	<i>Elaborate architectural issues using attached spreadsheet. Use this column to elaborate details that aren't captured in the spreadsheet.</i>	<i>Reference the applicable IECSA Environment containing this data exchange. Only one environment per step.</i>
1.1	Timer for beginning of interval	CustomerBuildingAutomationSystem		CustomerBuildingAutomationSystem sends signals to DERDevice manager for the upcoming interval. These commands would include generation and ancillary services support.	CustomerBuildingAutomationSystem	DERDevice manager	DERDevice schedule		DER Monitoring and Control
1.2	DERDevice receives schedule for interval	DERDevice Manager		DERDevice implements schedule starting or stopping generation and switching loads.		DERDevice devices	DERDevice Device Start/Stop/Set Commands		DER Monitoring and Control
1..3	DERDevice implements generation	DERDevice Manager		Monitors DERDevice performance and reports status to CustomerBuildingAutomationSystem	DERDevice manager	CustomerBuildingAutomationSystem	DERDevice Status		DER Monitoring and Control

¹ Note – A triggering event is not necessary if the completion of the prior step – leads to the transition of the following step.

#	Event	Primary Actor	Name of Process/Activity	Description of Process/Activity	Information Producer	Information Receiver	Name of Info Exchanged	Additional Notes	IECSA Environments
1.4	DERDevice performance data published	CustomerBuildingAutomationSystem		Makes DERDevice performance data available to EnergyServiceProvider	CustomerBuildingAutomationSystem	EnergyServiceProvider DERDevice and Ancillary Services Monitoring	DERDevice Status		Customer / ESP
1.5	Failure to meet DERDevice goals	CustomerBuildingAutomationSystem		If DERDevice goals are not met, the CustomerBuildingAutomationSystem will signal the customer with an alarm so that action can be taken.	CustomerBuildingAutomationSystem	Customer	DERDevice Status		Intra-Customer Site

2.1.3 Steps – Alternative / Exception Sequences

Describe any alternative or exception sequences that may be required that deviate from the normal course of activities. Note instructions are found in previous table.

#	Event	Primary Actor	Name of Process/Activity	Description of Process/Activity	Information Producer	Information Receiver	Name of Info Exchanged	Additional Notes	IECSA Environments

2.1.4 Post-conditions and Significant Results

Describe conditions that must exist at the conclusion of the Function. Identify significant items similar to that in the preconditions section.

Describe any significant results from the Function

<i>Actor/Activity</i>	<i>Post-conditions Description and Results</i>
DERDevice Manager	DERDevice is controlled based on the DERDevice schedule provided by the CustomerBuildingAutomationSystem

2.2 Architectural Issues in Interactions

Elaborate on all architectural issues in each of the steps outlined in each of the sequences above. Reference the Step by number..



Microsoft Excel
Worksheet

2.3 Diagram

For clarification, draw (by hand, by Power Point, by UML diagram) the interactions, identifying the Steps where possible.

3 Auxiliary Issues

3.1 References and contacts

Documents and individuals or organizations used as background to the function described; other functions referenced by this function, or acting as “sub” functions; or other documentation that clarifies the requirements or activities described. All prior work (intellectual property of the company or individual) or proprietary (non-publicly available) work must be so noted.

ID	Title or contact	Reference or contact information
[1]		
[2]		

3.2 Action Item List

As the function is developed, identify issues that still need clarification, resolution, or other notice taken of them. This can act as an Action Item list.

ID	Description	Status
[1]		
[2]		

3.3 Revision History

For reference and tracking purposes, indicate who worked on describing this function, and what aspect they undertook.

No	Date	Author	Description
0.			

This page intentionally left blank.

Demand Response/Customer Load Control – Non Price Responsive Programs

1 Descriptions of Function

All prior work (intellectual property of the company or individual) or proprietary (non-publicly available) work should be so noted.

This template has been removed due to consolidation.

This page intentionally left blank.

RTP - EnergyServiceProvider Energy and Ancillary Services Aggregation

1 Descriptions of Function

All prior work (intellectual property of the company or individual) or proprietary (non-publicly available) work should be so noted.

1.1 Function Name

RTP - EnergyServiceProvider Energy and Ancillary Services Aggregation

1.2 Function ID

IECSA identification number of the function

C-4,C-6.4

1.3 Brief Description

Describe briefly the scope, objectives, and rationale of the Function.

Energy Service Provider (EnergyServiceProvider) collects energy and ancillary services bids and offers from RTP and other DER subscribing customers. The EnergyServiceProvider combines those bids into an aggregate bid into the market operations bid/offer system. When accepted, the EnergyServiceProvider notifies the end customer of the status and requests scheduling of the services.

1.4 Narrative

A complete narrative of the Function from a Domain Expert's point of view, describing what occurs when, why, how, and under what conditions. This will be a separate document, but will act as the basis for identifying the Steps in Section 2.

Energy Service Provider (EnergyServiceProvider) collects energy and ancillary services bids and offers from RTP and other DER subscribing customers. The EnergyServiceProvider combines those bids into an aggregate bid into market operations. The incoming bids are prioritized and based on price, quality and size. Bids may be based upon distributed generation or other resource such as deferrable load or switch-able capacitors for reactive power supply/voltage support. These bids are combined and offered into the

market operations bid/offer system. Market Operations evaluates the bids against the energy and ancillary services needs in the system based upon the load forecast, energy schedules and marginal costs for generation. Market operations will notify the EnergyServiceProvider of acceptance of the bids and requests that the services be scheduled. The EnergyServiceProvider then determines the best set of customer bids to meet the accepted aggregate bid. The EnergyServiceProvider then notifies the selected customers of the accepted bids and requests that the services be scheduled.

It is possible that Market Operations may issue new RTP base tables if the energy bids significantly effect marginal costs. If so an iteration of the RTP pricing process may be initiated if the tariffs allow for such.

Some customers may be subscribers to independent energy and ancillary services aggregation provides who intern offer into Market Operations bid/offer system. This use case deals specifically with EnergyServiceProvider RTP customers.

1.5 Actor (Stakeholder) Roles

Describe all the people (their job), systems, databases, organizations, and devices involved in or affected by the Function (e.g. operators, system administrators, technicians, end users, service personnel, executives, SCADA system, real-time database, RTO, RTU, IED, power system). Typically, these actors are logically grouped by organization or functional boundaries or just for collaboration purpose of this use case. We need to identify these groupings and their relevant roles and understand the constituency. The same actor could play different roles in different Functions, but only one role in one Function. If the same actor (e.g. the same person) does play multiple roles in one Function, list these different actor-roles as separate rows.

<i>Grouping (Community)'</i>		<i>Group Description</i>
<i>Energy Service Provider (EnergyServiceProvider)</i>		Provides energy to end-use customers
<i>Actor Name</i>	<i>Actor Type (person, device, system etc.)</i>	<i>Actor Description</i>
EnergyService Provider Bid and Offer System	System	The system that receives energy and ancillary services bids from RTP customers holds that information and tracks the bids. Also notifies customers of acceptance or decline of bids and offers.
EnergyService	System	Combines and rates the incoming bids and aggregates them into a single or few

<i>Grouping (Community)'</i>		<i>Group Description</i>
<i>Energy Service Provider (EnergyServiceProvider)</i>		Provides energy to end-use customers
<i>Actor Name</i>	<i>Actor Type (person, device, system etc.)</i>	<i>Actor Description</i>
Provider Aggregation System		large bids for submission to the Market Operation Energy and Ancillary Services Bid/Offer system.
EnergyService Provider Bid Submittal System	System	Enters bids and offers to the Market Operation Energy and Ancillary Services Bid/Offer system.
EnergyService Provider	Community	This Community/

<i>Grouping (Community)'</i>		<i>Group Description</i>
<i>RTP Customer</i>		Energy end-use customers and their systems
<i>Actor Name</i>	<i>Actor Type (person, device, system etc.)</i>	<i>Actor Description</i>
Customer	Person or system	Submits Energy and/or Ancillary services bids to EnergyServiceProvider Bid/offer system.

<i>Grouping (Community)</i>		<i>Group Description</i>
<i>Market Operations</i>		Forecasts loads, determines optimal loads, and initiates process to determine tables of Base RTP values for the next hours and days
<i>Actor Name</i>	<i>Actor Type (person, device, system etc.)</i>	<i>Actor Description</i>
Market Ops. Bid and Offer System	System	The system that receives energy and ancillary services bids from EnergyServiceProvider, independent aggregators and large customers. Also notifies bidders of acceptance or decline of bids and offers.
MarketOperationSystem	Community	This Community

1.6 Information exchanged

Describe any information exchanged in this template.

<i>Information Object Name</i>	<i>Information Object Description</i>
Customer Bids and Offers	Bids for energy and ancillary services from RTP end-use customers to EnergyServiceProvider for aggregation.
Acceptance of Bids and Offers	Contractual acceptance to bids and offers made by RTP end-use customers
Aggregated Bids and Offers	Aggregated bids and offers for energy and ancillary services made by EnergyServiceProvider to Market Operations
Acceptance of Aggregated Bids and Offers	Contractual acceptance to bids and offers made by EnergyServiceProvider to Market Operations

1.7 Activities/Services

Describe or list the activities and services involved in this Function (in the context of this Function). An activity or service can be provided by a computer system, a set of applications, or manual procedures. These activities/services should be described at an appropriate level, with the understanding that sub-activities and services should be described if they are important for operational issues, automation needs, and implementation reasons. Other sub-activities/services could be left for later analysis.

<i>Activity/Service Name</i>	<i>Activities/Services Provided</i>

1.8 Contracts/Regulations

Identify any overall (human-initiated) contracts, regulations, policies, financial considerations, engineering constraints, pollution constraints, and other environmental quality issues that affect the design and requirements of the Function.

<i>Contract/Regulation</i>	<i>Impact of Contract/Regulation on Function</i>
Accepted Bid or Offer	Constitutes a contract to provide the bid service at the specified time

<i>Policy</i>	<i>From Actor</i>	<i>May</i>	<i>Shall Not</i>	<i>Shall</i>	<i>Description (verb)</i>	<i>To Actor</i>
Provide Service	Customer			X	Provide accepted services as bid	EnergyServiceProvider

<i>Constraint</i>	<i>Type</i>	<i>Description</i>	<i>Applies to</i>
Laws of physics	Environmental	Laws of physics for power system operations	All
Technology	Environmental	Technology constraints for providing real-time pricing information to all customers with RTP as part of their customer tariffs	All
Security	Environmental	Security policies and technologies must be established and used to address all security needs at the appropriate/contracted levels	All
Environmental		Carbon production limits may limit ability to generate	Customer

2 Step by Step Analysis of Function

Describe steps that implement the function. If there is more than one set of steps that are relevant, make a copy of the following section grouping (Preconditions and Assumptions, Steps normal sequence, and Steps alternate or exceptional sequence, Post conditions)

2.1 Steps to implement function

Name of this sequence.

2.1.1 Preconditions and Assumptions

Describe conditions that must exist prior to the initiation of the Function, such as prior state of the actors and activities

Identify any assumptions, such as what systems already exist, what contractual relations exist, and what configurations of systems are probably in place

Identify any initial states of information exchanged in the steps in the next section. For example, if a purchase order is exchanged in an activity, its precondition to the activity might be 'filled in but unapproved'.

<i>Actor/System/Information/Contract</i>	<i>Preconditions or Assumptions</i>
Customers	RTP Customers have calculated their bid and offers for Energy and Ancillary Services for the bid period.

2.1.2 Steps – Normal Sequence

Describe the normal sequence of events, focusing on steps that identify new types of information or new information exchanges or new interface issues to address. Should the sequence require detailed steps that are also used by other functions, consider creating a new “sub” function, then referring to that “subroutine” in this function. Remember that the focus should be less on the algorithms of the applications and more on the interactions and information flows between “entities”, e.g. people, systems, applications, data bases, etc. There should be a direct link between the narrative and these steps.

The numbering of the sequence steps conveys the order and concurrency and iteration of the steps occur. Using a Dewey Decimal scheme, each level of nested procedure call is separated by a dot ‘.’. Within a level, the sequence number comprises an optional letter and an integer number. The letter specifies a concurrent sequence within the next higher level; all letter sequences are concurrent with other letter sequences. The number specifies the sequencing of messages in a given letter sequence. The absence of a letter is treated as a default ‘main sequence’ in parallel with the lettered sequences.

Sequence 1:

*1.1 - Do step 1
1.2A.1 - In parallel to activity 2 B do step 1
1.2A.2 - In parallel to activity 2 B do step 2
1.2B.1 - In parallel to activity 2 A do step 1
1.2B.2 - In parallel to activity 2 A do step 2
1.3 - Do step 3
1.3.1 - nested step 3.1
1.3.2 - nested step 3.2*

Sequence 2:

*2.1 - Do step 1
2.2 - Do step 2*

#	Event	Primary Actor	Name of Process/Activity	Description of Process/Activity	Information Producer	Information Receiver	Name of Info Exchanged	Additional Notes	IECSA Environments
#	<i>Triggering event? Identify the name of the event.¹</i>	<i>What other actors are primarily responsible for the Process/Activity? Actors are defined in section0.</i>	<i>Label that would appear in a process diagram. Use action verbs when naming activity.</i>	<i>Describe the actions that take place in active and present tense. The step should be a descriptive noun/verb phrase that portrays an outline summary of the step. "If ...Then...Else" scenarios can be captured as multiple Actions or as separate steps.</i>	<i>What other actors are primarily responsible for Producing the information? Actors are defined in section0.</i>	<i>What other actors are primarily responsible for Receiving the information? Actors are defined in section0. (Note – May leave blank if same as Primary Actor)</i>	<i>Name of the information object. Information objects are defined in section 1.6</i>	<i>Elaborate architectural issues using attached spreadsheet. Use this column to elaborate details that aren't captured in the spreadsheet.</i>	<i>Reference the applicable IECSA Environment containing this data exchange. Only one environment per step.</i>
1.1	Customer completes bid / offer optimizations	Customer		Customer makes calculations indicating advantages to bidding energy or ancillary services to EnergyServiceProvider/aggregator. Customer transmits bids to EnergyServiceProvider.	Customer	EnergyService Provider Bid and Offer System	Customer Bids and Offers		Customer / ESP
1.2	EnergyService Provider Receives bids	EnergyService Provider Bid and Offer System		EnergyServiceProvider aggregates bid from multiple customers.	EnergyService Provider Bid and Offer System	EnergyService Provider Aggregation System	Customer Bids and Offers		RTOs / Market Participants RTOs / Market Participants

¹ Note – A triggering event is not necessary if the completion of the prior step – leads to the transition of the following step.

#	Event	Primary Actor	Name of Process/Activity	Description of Process/Activity	Information Producer	Information Receiver	Name of Info Exchanged	Additional Notes	IECSA Environments
1.3	EnergyServiceProvider Aggregates bids and offers	EnergyServiceProvider Aggregation System		EnergyServiceProvider submits bids and offers to Market operations energy and ancillary services bid and offer system for evaluation and acceptance	EnergyServiceProvider Aggregation System	Market Ops. Bid and Offer System	Aggregated Bids and Offers		RTOs / Market Participants RTOs / Market Participants
1.4	Market Operations evaluates bid/ offers	Market Ops. Bid and Offer System		Market Operations evaluates bids and offers from multiple sources and accepts some and rejects others. Notification of bid or offer status is sent to bidders	Market Ops. Bid and Offer System	EnergyServiceProvider Aggregation System	Acceptance of Aggregated Bids and Offers		RTOs / Market Participants RTOs / Market Participants
1.5	Market Ops accepts bids and offers	EnergyServiceProvider Aggregation System		EnergyServiceProvider evaluates the overall bid acceptance, and allocates various customer bids to fulfill commitments.	EnergyServiceProvider Aggregation System	EnergyServiceProvider Bid and Offer System	Acceptance of Bids and Offers		RTOs / Market Participants RTOs / Market Participants
1.6	EnergyServiceProvider bid acceptance	EnergyServiceProvider Bid and Offer System		Customers are notified by EnergyServiceProvider of bid status.	EnergyServiceProvider Bid and Offer System	Customer	Acceptance of Bids and Offers		Customer / ESP

2.1.3 Steps – Alternative / Exception Sequences

Describe any alternative or exception sequences that may be required that deviate from the normal course of activities. Note instructions are found in previous table.

#	Event	Primary Actor	Name of Process/Activity	Description of Process/Activity	Information Producer	Information Receiver	Name of Info Exchanged	Additional Notes	IECSA Environments

2.1.4 Post-conditions and Significant Results

Describe conditions that must exist at the conclusion of the Function. Identify significant items similar to that in the preconditions section.

Describe any significant results from the Function

<i>Actor/Activity</i>	<i>Post-conditions Description and Results</i>
EnergyServiceProvider	Committed to providing accepted aggregated energy and ancillary services bids.
Customer	Committed to providing accepted energy and ancillary services bids.

2.2 Architectural Issues in Interactions

Elaborate on all architectural issues in each of the steps outlined in each of the sequences above. Reference the Step by number.



Microsoft Excel
Worksheet

2.3 Diagram

For clarification, draw (by hand, by Power Point, by UML diagram) the interactions, identifying the Steps where possible.

3 Auxiliary Issues

3.1 References and contacts

Documents and individuals or organizations used as background to the function described; other functions referenced by this function, or acting as “sub” functions; or other documentation that clarifies the requirements or activities described. All prior work (intellectual property of the company or individual) or proprietary (non-publicly available) work must be so noted.

ID	Title or contact	Reference or contact information
[1]		
[2]		

3.2 Action Item List

As the function is developed, identify issues that still need clarification, resolution, or other notice taken of them. This can act as an Action Item list.

ID	Description	Status
[1]		
[2]		

3.3 Revision History

For reference and tracking purposes, indicate who worked on describing this function, and what aspect they undertook.

No	Date	Author	Description
0.9	3/1/04	Jack King	First cut completed.

This page intentionally left blank.

RTP - ESP Customer Specific RTP Calculator

1 Descriptions of Function

All prior work (intellectual property of the company or individual) or proprietary (non-publicly available) work should be so noted.

1.1 Function Name

ESP Customer Specific RTP Calculator

1.2 Function ID

IECSA identification number of the function

C-4

1.3 Brief Description

Describe briefly the scope, objectives, and rationale of the Function.

This function uses the base RTP values calculated by Market Operators to calculate customer-specific RTP rates, based on their tariffs and market conditions.

1.4 Narrative

A complete narrative of the Function from a Domain Expert's point of view, describing what occurs when, why, how, and under what conditions. This will be a separate document, but will act as the basis for identifying the Steps in Section 2.

This function calculates the customer specific RTP schedule that is sent to the customer's BAS for implementation. The calculation is first based on the base RTP calculations performed at the Market Operators level that take into account many factors including the marginal energy costs, costs of losses, risk adjustments among others. These calculations are performed for each settlement interval in the RTP schedule for every delivery node in the system.

The ESP uses the base RTP and applies factors related to losses and other costs as well as local tariffs and contracts with the customer. The RTP may be combined with the CBL for the customer if a two part rate is in place. Once the customer specify RTP schedule is calculated, it is communicated to the customer or the customer Building Automation System (BAS) where the customer can optimize their energy usage

1.5 Actor (Stakeholder) Roles

Describe all the people (their job), systems, databases, organizations, and devices involved in or affected by the Function (e.g. operators, system administrators, technicians, end users, service personnel, executives, SCADA system, real-time database, RTO, RTU, Intelligent Electronic Device, power system). Typically, these actors are logically grouped by organization or functional boundaries or just for collaboration purpose of this use case. We need to identify these groupings and their relevant roles and understand the constituency. The same actor could play different roles in different Functions, but only one role in one Function. If the same actor (e.g. the same person) does play multiple roles in one Function, list these different actor-roles as separate rows.

<i>Grouping (Community)</i>		<i>Group Description</i>
Energy Service Providers		Receives to base RTP tables and calculates customer-specific RTP tables
<i>Actor Name</i>	<i>Actor Type (person, device, system etc.)</i>	<i>Actor Description</i>
RTPCalculator	System	The program that integrates Base RTP calculations from Market Operations and customer specific tariffs and contracts to produce customer specific RPT schedules for the settlement period.
EnergyServiceProvider		

<i>Grouping (Community)'</i>		<i>Group Description</i>
Market Operations		Forecasts loads, determines optimal loads, and initiates process to determine tables of Base RTP values for the next hours and days
<i>Actor Name</i>	<i>Actor Type (person, device, system etc.)</i>	<i>Actor Description</i>
Market Interface Server	System	Provides access to market information to ESPs and other market participants. In particular, the base RTP tables are provided.

<i>Grouping (Community)'</i>		<i>Group Description</i>
Customer		Energy end-use customers and their systems.
<i>Actor Name</i>	<i>Actor Type (person, device, system etc.)</i>	<i>Actor Description</i>
CustomerBuildingAutomationSystem	Person or system	The customer system that receives the customer specific RTP schedule and acts upon it. This could be a person or automated process that is part of a Building Automation System.
Customer		

Replicate this table for each logic group.

1.6 Information exchanged

Describe any information exchanged in this template.

<i>Information Object Name</i>	<i>Information Object Description</i>
Base RTP schedules	RTP schedules for the market based on load forecasts, weather forecasts, system configuration and energy costs among other factors. RTP schedule is a table of time and price for the settlement period.
Customer Specific RTP schedules	RTP schedules calculated for specific customers. RTP schedule is a table of time and price for the settlement period.

1.7 Activities/Services

Describe or list the activities and services involved in this Function (in the context of this Function). An activity or service can be provided by a computer system, a set of applications, or manual procedures. These activities/services should be described at an appropriate level, with the understanding that sub-activities and services should be described if they are important for operational issues, automation needs, and implementation reasons. Other sub-activities/services could be left for later analysis.

<i>Activity/Service Name</i>	<i>Activities/Services Provided</i>

1.8 Contracts/Regulations

Identify any overall (human-initiated) contracts, regulations, policies, financial considerations, engineering constraints, pollution constraints, and other environmental quality issues that affect the design and requirements of the Function.

<i>Contract/Regulation</i>	<i>Impact of Contract/Regulation on Function</i>
Market tariffs	Controls the content and frequency of base RTP schedules
Customer RTP contracts with ESPs	Controls the content and delivery of customer RTP schedules. Drives technology and security requirements

<i>Policy</i>	<i>From Actor</i>	<i>May</i>	<i>Shall Not</i>	<i>Shall</i>	<i>Description (verb)</i>	<i>To Actor</i>
Provide RTP schedules				X	Provide RTP schedules for customers who subscribe to RTP tariffs	Customer
Security and compliance	ENERGYSERVICEPROVIDER			X	Meet security requirements and ensure compliance with all critical information in tariffs, laws and policies must be auditable	Customer
Delivery	ENERGYSERVICEPROVIDER	X			Undertake delivery of RFP data via reasonable variations in implementation approaches through robust system designs	Customer

<i>Constraint</i>	<i>Type</i>	<i>Description</i>	<i>Applies to</i>
Laws of physics	Environmental	Laws of physics for power system operations	All
Technology	Environmental	Technology constraints for providing real-time pricing information to all customers with RTP as part of their customer tariffs	All
Security	Environmental	Security policies and technologies must be established and used to address all security needs at the appropriate/contracted levels	All

2 Step by Step Analysis of Function

Describe steps that implement the function. If there is more than one set of steps that are relevant, make a copy of the following section grouping (Preconditions and Assumptions, Steps normal sequence, and Steps alternate or exceptional sequence, Post conditions)

2.1 Steps to implement function

Calculation of Customer Specific RTP schedule

2.1.1 Preconditions and Assumptions

Describe conditions that must exist prior to the initiation of the Function, such as prior state of the actors and activities

Identify any assumptions, such as what systems already exist, what contractual relations exist, and what configurations of systems are probably in place

Identify any initial states of information exchanged in the steps in the next section. For example, if a purchase order is exchanged in an activity, its precondition to the activity might be 'filled in but unapproved'.

<i>Actor/System/Information/Contract</i>	<i>Preconditions or Assumptions</i>
Market Operations	Calculated energy prices for the settlement period based of forecasted loads, weather and other factors as described in Load Forecasting and Base RTP Calculation use cases.

2.1.2 Steps – Normal Sequence

Describe the normal sequence of events, focusing on steps that identify new types of information or new information exchanges or new interface issues to address. Should the sequence require detailed steps that are also used by other functions, consider creating a new “sub” function, then referring to that “subroutine” in this function. Remember that the focus should be less on the algorithms of the applications and more on the interactions and information flows between “entities”, e.g. people, systems, applications, data bases, etc. There should be a direct link between the narrative and these steps.

The numbering of the sequence steps conveys the order and concurrency and iteration of the steps occur. Using a Dewey Decimal scheme, each level of nested procedure call is separated by a dot ‘.’. Within a level, the sequence number comprises an optional letter and an integer number. The letter specifies a concurrent sequence within the next higher level; all letter sequences are concurrent with other letter sequences. The number specifies the sequencing of messages in a given letter sequence. The absence of a letter is treated as a default ‘main sequence’ in parallel with the lettered sequences.

Sequence 1:

*1.1 - Do step 1
1.2A.1 - In parallel to activity 2 B do step 1
1.2A.2 - In parallel to activity 2 B do step 2
1.2B.1 - In parallel to activity 2 A do step 1
1.2B.2 - In parallel to activity 2 A do step 2
1.3 - Do step 3
1.3.1 - nested step 3.1
1.3.2 - nested step 3.2*

Sequence 2:

*2.1 - Do step 1
2.2 - Do step 2*

#	Event	Primary Actor	Name of Process/Activity	Description of Process/Activity	Information Producer	Information Receiver	Name of Info Exchanged	Additional Notes	IECSA Environments
#	<i>Triggering event? Identify the name of the event.¹</i>	<i>What other actors are primarily responsible for the Process/Activity? Actors are defined in section 1.5.</i>	<i>Label that would appear in a process diagram. Use action verbs when naming activity.</i>	<i>Describe the actions that take place in active and present tense. The step should be a descriptive noun/verb phrase that portrays an outline summary of the step. "If ...Then...Else" scenarios can be captured as multiple Actions or as separate steps.</i>	<i>What other actors are primarily responsible for Producing the information? Actors are defined in section 1.5.</i>	<i>What other actors are primarily responsible for Receiving the information? Actors are defined in section 1.5.</i> <i>(Note – May leave blank if same as Primary Actor)</i>	<i>Name of the information object. Information objects are defined in section 1.6</i>	<i>Elaborate architectural issues using attached spreadsheet. Use this column to elaborate details that aren't captured in the spreadsheet.</i>	<i>Reference the applicable IECSA Environment containing this data exchange. Only one environment per step.</i>
1.1	Base RTP table updates become available on Market Interface Server	Market Interface Server		Base RTP schedules are published on market interface server where the Energy Service Providers RTP system can access them. RTP Calculator application receives information on Base Real-Time Prices and calculates the customer-specific RTP tables for different customers based on contracts and tariffs.	Market Interface Server	RTP Calculator	Base RTP schedules		RTOs / Market Participants RTOs / Market Participants
1.2	Updated Customer RTP schedules available	RTP Calculator		RTP calculator publishes customer specific schedules. These schedules are made available to the customers via agreed communications method. This could be Fax, Email or through WWW interface.	RTP Calculator	Customer Building Automation System	Customer Specific RTP schedules		Customer / ESP

¹ Note – A triggering event is not necessary if the completion of the prior step – leads to the transition of the following step.

2.1.3 Steps – Alternative / Exception Sequences

Describe any alternative or exception sequences that may be required that deviate from the normal course of activities. Note instructions are found in previous table.

#	Event	Primary Actor	Name of Process/Activity	Description of Process/Activity	Information Producer	Information Receiver	Name of Info Exchanged	Additional Notes	IECSA Environments

2.1.4 Post-conditions and Significant Results

Describe conditions that must exist at the conclusion of the Function. Identify significant items similar to that in the preconditions section.

Describe any significant results from the Function

<i>Actor/Activity</i>	<i>Post-conditions Description and Results</i>
RTPCalculator	New or updated Customer Specific RTP schedules are available to the Energy Service Provider’s RTP subscribing customers.

2.2 Architectural Issues in Interactions

Elaborate on all architectural issues in each of the steps outlined in each of the sequences above. Reference the Step by number.



Microsoft Excel
Worksheet

2.3 Diagram

For clarification, draw (by hand, by Power Point, by UML diagram) the interactions, identifying the Steps where possible.

3 Auxiliary Issues

3.1 References and contacts

Documents and individuals or organizations used as background to the function described; other functions referenced by this function, or acting as “sub” functions; or other documentation that clarifies the requirements or activities described. All prior work (intellectual property of the company or individual) or proprietary (non-publicly available) work must be so noted.

ID	Title or contact	Reference or contact information
[1]		
[2]		

3.2 Action Item List

As the function is developed, identify issues that still need clarification, resolution, or other notice taken of them. This can act as an Action Item list.

ID	Description	Status
[1]		
[2]		

3.3 Revision History

For reference and tracking purposes, indicate who worked on describing this function, and what aspect they undertook.

No	Date	Author	Description
0.			

RTP – Load Forecasting

1 Descriptions of Function

All prior work (intellectual property of the company or individual) or proprietary (non-publicly available) work should be so noted.

1.1 Function Name

Real Time Pricing – Load Forecasting

1.2 Function ID

IECSA identification number of the function

C-4,C-7

1.3 Brief Description

Describe briefly the scope, objectives, and rationale of the Function.

The Load Forecasting function of RTP uses transmission and distribution information, energy schedules, weather, and past history to forecast loads on an interval-by-interval basis. The forecast is used, in part, to develop the Base RTP calculation.

1.4 Narrative

A complete narrative of the Function from a Domain Expert's point of view, describing what occurs when, why, how, and under what conditions. This will be a separate document, but will act as the basis for identifying the Steps in Section 2.

Periodically, the Market Timer, (the RTO/ISO market operations system or other market entity, depending upon the market design) forecasts power system conditions for a specific period, say the next 24 hours, based on energy schedules and prices already submitted, ancillary services available, weather conditions, day of the week, scheduled outage information from transmission and distribution operations, and real-time information from transmission and distribution operations, etc.

The Load Forecasting function uses historical load forecasts databases and combines that information about the energy generation schedules, transmission and distribution system constraints and ancillary services bids to estimate the load for areas within the system studied. Various load forecasting packages approach the problem in different ways but all use these input and combine weather, time of the year, day of the week and other correlated variables to predict customer behavior for the specific settlement periods being forecasted.

1.5 Actor (Stakeholder) Roles

Describe all the people (their job), systems, databases, organizations, and devices involved in or affected by the Function (e.g. operators, system administrators, technicians, end users, service personnel, executives, SCADA system, real-time database, RTO, RTU, IED, power system). Typically, these actors are logically grouped by organization or functional boundaries or just for collaboration purpose of this use case. We need to identify these groupings and their relevant roles and understand the constituency. The same actor could play different roles in different Functions, but only one role in one Function. If the same actor (e.g. the same person) does play multiple roles in one Function, list these different actor-roles as separate rows.

<i>Grouping (Community)'</i>		<i>Group Description</i>
Market Operations		
<i>Actor Name</i>	<i>Actor Type (person, device, system etc.)</i>	<i>Actor Description</i>
Market Timer	System	Timer to trigger application execution at specific times of the day, week, month, etc
Forecast Loads	Database	Load forecasts, based on different inputs and possible market scenarios
EnergySchedule Database	Database	Energy schedules submitted to Market Operations
Ancillary Services Bids/Offers	Database	Ancillary Services bids and offers submitted to Market Operations

<i>Grouping (Community)</i>		<i>Group Description</i>
Market Operations		
<i>Actor Name</i>	<i>Actor Type (person, device, system etc.)</i>	<i>Actor Description</i>
HistoricLoadDatabase	Database	Provides historical load data for the system
WeatherService	System	Provides weather forecasts
LoadForecaster		

<i>Grouping(Community)</i>		<i>Group Description</i>
Transmission Operations Systems		Provides power system configuration and real-time data to market operations
<i>Actor Role Name</i>	<i>Actor Type (person, device, system etc.)</i>	<i>Role Description</i>
Transmission System Data	System	Transmission power system data, including scheduled outages, transmission constraints, and real-time information

<i>Grouping(Community)</i>		<i>Group Description</i>
Distribution Operations Systems		Provides real-time data to market operations and monitors (larger) DER devices
<i>Actor Role Name</i>	<i>Actor Type (person, device, system etc.)</i>	<i>Role Description</i>
Distribution System Data	System	Distribution power system data, including scheduled outages, distribution constraints, and real-time information

Replicate this table for each logic group.

1.6 Information exchanged

Describe any information exchanged in this template.

<i>Information Object Name</i>	<i>Information Object Description</i>
EnergyScheduleDatabase	Energy scheduled for the settlement period from generation facilities
Ancillary Services Bids	Bids offered and accepted for ancillary services
Weather Forecasts	Weather forecast data for the settlement period.
Transmission outage and constraint data	Transmission power system data, including scheduled outages, transmission constraints, and real-time information
Distribution outage and constraint data	Distribution power system data, including scheduled outages, distribution constraints, and real-time information
Historical Load Data	Database of historical load information used by forecasting algorithms.

<i>Information Object Name</i>	<i>Information Object Description</i>
Load Forecast	Prediction of load at significant points throughout the system for the settlement period.

1.7 Activities/Services

Describe or list the activities and services involved in this Function (in the context of this Function). An activity or service can be provided by a computer system, a set of applications, or manual procedures. These activities/services should be described at an appropriate level, with the understanding that sub-activities and services should be described if they are important for operational issues, automation needs, and implementation reasons. Other sub-activities/services could be left for later analysis.

<i>Activity/Service Name</i>	<i>Activities/Services Provided</i>
Load forecast function	Function uses transmission and distribution information, energy schedules, weather, and past history to forecast loads
ESP ancillary services aggregation function	Function that aggregates ancillary service bids/offers and manages the submittal to the market operations system
Market operations energy services function	Function that capture and analyze energy schedules to ensure all power system constraints are met
Market operations ancillary services function	Function that captures offers/bids of ancillary services and categorizes them for use during the “settlement” period

1.8 Contracts/Regulations

Identify any overall (human-initiated) contracts, regulations, policies, financial considerations, engineering constraints, pollution constraints, and other environmental quality issues that affect the design and requirements of the Function.

<i>Contract/Regulation</i>	<i>Impact of Contract/Regulation on Function</i>
Utility operations	FERC and state regulators oversee utility operations

<i>Policy</i>	<i>From Actor</i>	<i>May</i>	<i>Shall Not</i>	<i>Shall</i>	<i>Description (verb)</i>	<i>To Actor</i>

<i>Constraint</i>	<i>Type</i>	<i>Description</i>	<i>Applies to</i>
Laws of physics	Environmental	Laws of physics for power system operations	All

2 Step by Step Analysis of Function

Describe steps that implement the function. If there is more than one set of steps that are relevant, make a copy of the following section grouping (Preconditions and Assumptions, Steps normal sequence, and Steps alternate or exceptional sequence, Post conditions)

2.1 Steps to implement function

Name of this sequence.

2.1.1 Preconditions and Assumptions

Describe conditions that must exist prior to the initiation of the Function, such as prior state of the actors and activities

Identify any assumptions, such as what systems already exist, what contractual relations exist, and what configurations of systems are probably in place

Identify any initial states of information exchanged in the steps in the next section. For example, if a purchase order is exchanged in an activity, its precondition to the activity might be 'filled in but unapproved'.

<i>Actor/System/Information/Contract</i>	<i>Preconditions or Assumptions</i>
EnergyScheduleDatabase	Energy scheduler have been determined for the settlement period.
Transmission Operations Systems	Transmission power system data, including scheduled outages and transmission constraints have been determined for the settlement period.
Distribution Operations Systems	Distribution power system data, including scheduled outages have been determined for the settlement period.

2.1.2 Steps – Normal Sequence

Describe the normal sequence of events, focusing on steps that identify new types of information or new information exchanges or new interface issues to address. Should the sequence require detailed steps that are also used by other functions, consider creating a new “sub” function, then referring to that “subroutine” in this function. Remember that the focus should be less on the algorithms of the applications and more on the interactions and information flows between “entities”, e.g. people, systems, applications, data bases, etc. There should be a direct link between the narrative and these steps.

The numbering of the sequence steps conveys the order and concurrency and iteration of the steps occur. Using a Dewey Decimal scheme, each level of nested procedure call is separated by a dot ‘.’. Within a level, the sequence number comprises an optional letter and an integer number. The letter specifies a concurrent sequence within the next higher level; all letter sequences are concurrent with other letter sequences. The number specifies the sequencing of messages in a given letter sequence. The absence of a letter is treated as a default ‘main sequence’ in parallel with the lettered sequences.

Sequence 1:

*1.1 - Do step 1
1.2A.1 - In parallel to activity 2 B do step 1
1.2A.2 - In parallel to activity 2 B do step 2
1.2B.1 - In parallel to activity 2 A do step 1
1.2B.2 - In parallel to activity 2 A do step 2
1.3 - Do step 3
1.3.1 - nested step 3.1
1.3.2 - nested step 3.2*

Sequence 2:

*2.1 - Do step 1
2.2 - Do step 2*

#	Event	Primary Actor	Name of Process/Activity	Description of Process/Activity	Information Producer	Information Receiver	Name of Info Exchanged	Additional Notes	IECSA Environments
#	Triggering event? Identify the name of the event. ¹	What other actors are primarily responsible for the Process/Activity? Actors are defined in section0.	Label that would appear in a process diagram. Use action verbs when naming activity.	Describe the actions that take place in active and present tense. The step should be a descriptive noun/verb phrase that portrays an outline summary of the step. "If ... Then...Else" scenarios can be captured as multiple Actions or as separate steps.	What other actors are primarily responsible for Producing the information? Actors are defined in section0.	What other actors are primarily responsible for Receiving the information? Actors are defined in section0. (Note – May leave blank if same as Primary Actor)	Name of the information object. Information objects are defined in section 1.6	Elaborate architectural issues using attached spreadsheet. Use this column to elaborate details that aren't captured in the spreadsheet.	Reference the applicable IECSA Environment containing this data exchange. Only one environment per step.
1.1	Market Timer initiates the forecast power system condition	Market Timer		Forecast power system conditions for the next "settlement" periods					Intra-Control Center
1.1.1		LoadForecaster		Load energy schedules from EnergyScheduleDatabase.	EnergySchedule Database		Energy schedules	APIs needed between databases and application	Intra-Control Center
1.1.2		LoadForecaster		Load Ancillary services bids/offers from database	Ancillary Services Bids/Offers		Ancillary Services Bids	APIs needed between databases and application	Control Centers / ESPs
1.1.3		LoadForecaster		Load weather forecasts from WeatherService	WeatherService		Weather forecasts	Existing weather protocol and weather format must be used	Intra-Control Center
1.1.4		LoadForecaster		Load historical load data a from historical load database	HistoricLoadDat abase		Historical load data	APIs needed between databases and application	Intra-Control Center

¹ Note – A triggering event is not necessary if the completion of the prior step – leads to the transition of the following step.

#	Event	Primary Actor	Name of Process/Activity	Description of Process/Activity	Information Producer	Information Receiver	Name of Info Exchanged	Additional Notes	IECSA Environments
1.1.5		LoadForecaster		Load transmission system information for outages and constraints	Transmission System Data		Transmission outage and constraint data	Inter utility communications must be supported	Intra-Control Center
1.1.6		LoadForecaster		Load distribution system information for outages and constraints	Distribution System Data		Distribution outage and constraint data	Inter utility communications must be supported	Intra-Control Center
1.2	Completion of Load Forecasting application	LoadForecaster		Post results of load forecast to load forecast database for other applications to access (RTP base rate calculator)	LoadForecaster	Forecast Loads	Load Forecast	APIs needed between databases and application	Control Centers / ESPs

2.1.3 Steps – Alternative / Exception Sequences

Describe any alternative or exception sequences that may be required that deviate from the normal course of activities. Note instructions are found in previous table.

#	Event	Primary Actor	Name of Process/Activity	Description of Process/Activity	Information Producer	Information Receiver	Name of Info Exchanged	Additional Notes	IECSA Environments

2.1.4 Post-conditions and Significant Results

Describe conditions that must exist at the conclusion of the Function. Identify significant items similar to that in the preconditions section.

Describe any significant results from the Function

<i>Actor/Activity</i>	<i>Post-conditions Description and Results</i>
LoadForecaster	Post results of load forecast to load forecast database for other applications to access (RTP base rate calculator)

2.2 Architectural Issues in Interactions

Elaborate on all architectural issues in each of the steps outlined in each of the sequences above. Reference the Step by number..



Microsoft Excel
Worksheet

2.3 Diagram

For clarification, draw (by hand, by Power Point, by UML diagram) the interactions, identifying the Steps where possible.

3 Auxiliary Issues

3.1 References and contacts

Documents and individuals or organizations used as background to the function described; other functions referenced by this function, or acting as “sub” functions; or other documentation that clarifies the requirements or activities described. All prior work (intellectual property of the company or individual) or proprietary (non-publicly available) work must be so noted.

ID	Title or contact	Reference or contact information
[1]		
[2]		

3.2 Action Item List

As the function is developed, identify issues that still need clarification, resolution, or other notice taken of them. This can act as an Action Item list.

ID	Description	Status
[1]		
[2]		

3.3 Revision History

For reference and tracking purposes, indicate who worked on describing this function, and what aspect they undertook.

No	Date	Author	Description
1.0	2/6/2004	Jack King	Version 1.0 in template version 28

This page intentionally left blank.

RTP – Market Operations Ancillary Services

1 Descriptions of Function

All prior work (intellectual property of the company or individual) or proprietary (non-publicly available) work should be so noted.

1.1 Function Name

RTP – Market Operations Ancillary Services

1.2 Function ID

IECSA identification number of the function

C-4

1.3 Brief Description

Describe briefly the scope, objectives, and rationale of the Function.

Market Operations Energy Services, for the purposes of this use case, collects bid and offers into the ancillary services market from Energy Service Providers (EnergyServiceProvider) and other aggregators of distributed ancillary resources.

1.4 Narrative

A complete narrative of the Function from a Domain Expert's point of view, describing what occurs when, why, how, and under what conditions. This will be a separate document, but will act as the basis for identifying the Steps in Section 2.

Market Operations Energy Services, for the purposes of this use case, collects bid and offers into the ancillary services market from Energy Service Providers (EnergyServiceProvider) and other aggregators of distributed ancillary resources. Market Operations evaluates incoming bids against needs and accepts or rejects those offers.

1.5 Actor (Stakeholder) Roles

Describe all the people (their job), systems, databases, organizations, and devices involved in or affected by the Function (e.g. operators, system administrators, technicians, end users, service personnel, executives, SCADA system, real-time database, RTO, RTU, IED, power system). Typically, these actors are logically grouped by organization or functional boundaries or just for collaboration purpose of this use case. We need to identify these groupings and their relevant roles and understand the constituency. The same actor could play different roles in different Functions, but only one role in one Function. If the same actor (e.g. the same person) does play multiple roles in one Function, list these different actor-roles as separate rows.

Replicate this table for each logic group.

<i>Grouping (Community)</i>		<i>Group Description</i>
<i>MarketOperationSystem</i>		
<i>Actor Name</i>	<i>Actor Type (person, device, system etc.)</i>	<i>Actor Description</i>
BidEvaluationSystem	System	Evaluates bids and offers for energy services and accepts those that meet the criteria established by the market operator.
MarketInterfaceServer	System	Provides access to market information to ESPs and other market participants.
MarketOperationSystem	Community	this

<i>Grouping (Community)'</i>		<i>Group Description</i>
<i>Energy Service Providers</i>		<i>Provide Energy to end use customers</i>
<i>Actor Name</i>	<i>Actor Type (person, device, system etc.)</i>	<i>Actor Description</i>
EnergyService Provider Aggregation System	System	Combines and rates the incoming bids and aggregates them into a single or few large bids for submission to the Market Operation Energy and Ancillary Services Bid/Offer system.
EnergyService Provider	Community	this

1.6 Information exchanged

Describe any information exchanged in this template.

<i>Information Object Name</i>	<i>Information Object Description</i>
Aggregate ancillary services bids and offers	Bids and offers for ancillary resources offered through the EnergyServiceProvider aggregation system
Accepted ancillary services bids and offers	Accepted offers and bids returned to the EnergyServiceProvider for scheduling and action

1.7 Activities/Services

Describe or list the activities and services involved in this Function (in the context of this Function). An activity or service can be provided by a computer system, a set of applications, or manual procedures. These activities/services should be described at an appropriate level, with the understanding that sub-activities and services should be described if they are important for operational issues, automation needs, and implementation reasons. Other sub-activities/services could be left for later analysis.

<i>Activity/Service Name</i>	<i>Activities/Services Provided</i>

1.8 Contracts/Regulations

Identify any overall (human-initiated) contracts, regulations, policies, financial considerations, engineering constraints, pollution constraints, and other environmental quality issues that affect the design and requirements of the Function.

<i>Contract/Regulation</i>	<i>Impact of Contract/Regulation on Function</i>
Accepted Bid or Offer	Constitutes a contract to provide the bid service at the specified time

<i>Policy</i>	<i>From Actor</i>	<i>May</i>	<i>Shall Not</i>	<i>Shall</i>	<i>Description (verb)</i>	<i>To Actor</i>
Provide Service	EnergyServiceProvider			X	Provide accepted services as bid	MarketOperationSystem

<i>Constraint</i>	<i>Type</i>	<i>Description</i>	<i>Applies to</i>
Laws of physics	Environmental	Laws of physics for power system operations	All
Technology	Environmental	Technology constraints for providing real-time pricing information to all customers with RTP as part of their customer tariffs	All
Security	Environmental	Security policies and technologies must be established and used to address all security needs at the appropriate/contracted levels	All

2 Step by Step Analysis of Function

Describe steps that implement the function. If there is more than one set of steps that are relevant, make a copy of the following section grouping (Preconditions and Assumptions, Steps normal sequence, and Steps alternate or exceptional sequence, Post conditions)

2.1 Steps to implement function

Name of this sequence.

2.1.1 Preconditions and Assumptions

Describe conditions that must exist prior to the initiation of the Function, such as prior state of the actors and activities

Identify any assumptions, such as what systems already exist, what contractual relations exist, and what configurations of systems are probably in place

Identify any initial states of information exchanged in the steps in the next section. For example, if a purchase order is exchanged in an activity, its precondition to the activity might be 'filled in but unapproved'.

<i>Actor/System/Information/Contract</i>	<i>Preconditions or Assumptions</i>
EnergyServiceProvider	Completed aggregation of ancillary services bids and offers.

2.1.2 Steps – Normal Sequence

Describe the normal sequence of events, focusing on steps that identify new types of information or new information exchanges or new interface issues to address. Should the sequence require detailed steps that are also used by other functions, consider creating a new “sub” function, then referring to that “subroutine” in this function. Remember that the focus should be less on the algorithms of the applications and more on the interactions and information flows between “entities”, e.g. people, systems, applications, data bases, etc. There should be a direct link between the narrative and these steps.

The numbering of the sequence steps conveys the order and concurrency and iteration of the steps occur. Using a Dewey Decimal scheme, each level of nested procedure call is separated by a dot ‘.’. Within a level, the sequence number comprises an optional letter and an integer number. The letter specifies a concurrent sequence within the next higher level; all letter sequences are concurrent with other letter sequences. The number specifies the sequencing of messages in a given letter sequence. The absence of a letter is treated as a default ‘main sequence’ in parallel with the lettered sequences.

Sequence 1:

*1.1 - Do step 1
1.2A.1 - In parallel to activity 2 B do step 1
1.2A.2 - In parallel to activity 2 B do step 2
1.2B.1 - In parallel to activity 2 A do step 1
1.2B.2 - In parallel to activity 2 A do step 2
1.3 - Do step 3
1.3.1 - nested step 3.1
1.3.2 - nested step 3.2*

Sequence 2:

*2.1 - Do step 1
2.2 - Do step 2*

#	Event	Primary Actor	Name of Process/Activity	Description of Process/Activity	Information Producer	Information Receiver	Name of Info Exchanged	Additional Notes	IECSA Environments
#	<i>Triggering event? Identify the name of the event.¹</i>	<i>What other actors are primarily responsible for the Process/Activity? Actors are defined in section 1.5.</i>	<i>Label that would appear in a process diagram. Use action verbs when naming activity.</i>	<i>Describe the actions that take place in active and present tense. The step should be a descriptive noun/verb phrase that portrays an outline summary of the step. "If ...Then...Else" scenarios can be captured as multiple Actions or as separate steps.</i>	<i>What other actors are primarily responsible for Producing the information? Actors are defined in section 1.5.</i>	<i>What other actors are primarily responsible for Receiving the information? Actors are defined in section 1.5. (Note – May leave blank if same as Primary Actor)</i>	<i>Name of the information object. Information objects are defined in section 1.6</i>	<i>Elaborate architectural issues using attached spreadsheet. Use this column to elaborate details that aren't captured in the spreadsheet.</i>	<i>Reference the applicable IECSA Environment containing this data exchange. Only one environment per step.</i>
1.1	EnergyServiceProvider aggregates bids and offers	EnergyServiceProvider Aggregation System		EnergyServiceProvider transmits ancillary services bid/offer data to market operations	EnergyServiceProvider	MarketInterfaceServer	Aggregate ancillary services bids and offers		Control Centers / ESPs
1.2	Completion of previous Step	BidEvaluationSystem		Bid evaluation system processes loads data from market interface server. Bids are processed and evaluated against needs for the period. Some or all of the bids maybe accepted or rejected.	MarketInterfaceServer	BidEvaluationSystem	Aggregate ancillary services bids and offers		RTOs / Market Participants RTOs / Market Participants
1.3	Completion of previous Step	BidEvaluationSystem		Acceptance or rejections status is transferred to the market interface server	BidEvaluationSystem	MarketInterfaceServer	Accepted ancillary services bids and offers		RTOs / Market Participants RTOs / Market Participants

¹ Note – A triggering event is not necessary if the completion of the prior step – leads to the transition of the following step.

#	Event	Primary Actor	Name of Process/Activity	Description of Process/Activity	Information Producer	Information Receiver	Name of Info Exchanged	Additional Notes	IECSA Environments
1.4	Timer	EnergyServiceProvider		EnergyServiceProvider polls Market Server for bid status. Status is transferred to the EnergyServiceProvider Aggregation System.	MarketInterfaceServer	EnergyServiceProvider Aggregation System	Accepted ancillary services bids and offers		Control Centers / ESPs

2.1.3 Steps – Alternative / Exception Sequences

Describe any alternative or exception sequences that may be required that deviate from the normal course of activities. Note instructions are found in previous table.

#	Event	Primary Actor	Name of Process/Activity	Description of Process/Activity	Information Producer	Information Receiver	Name of Info Exchanged	Additional Notes	IECSA Environments

2.1.4 Post-conditions and Significant Results

Describe conditions that must exist at the conclusion of the Function. Identify significant items similar to that in the preconditions section.

Describe any significant results from the Function

<i>Actor/Activity</i>	<i>Post-conditions Description and Results</i>
EnergyServiceProvider	Committed to providing accepted aggregated ancillary bids.

<i>Actor/Activity</i>	<i>Post-conditions Description and Results</i>
MarketOperationSystem	Committed to honoring accepted ancillary services bids and offers.

2.2 Architectural Issues in Interactions

Elaborate on all architectural issues in each of the steps outlined in each of the sequences above. Reference the Step by number..



Microsoft Excel
Worksheet

2.3 Diagram

For clarification, draw (by hand, by Power Point, by UML diagram) the interactions, identifying the Steps where possible.

3 Auxiliary Issues

3.1 References and contacts

Documents and individuals or organizations used as background to the function described; other functions referenced by this function, or acting as “sub” functions; or other documentation that clarifies the requirements or activities described. All prior work (intellectual property of the company or individual) or proprietary (non-publicly available) work must be so noted.

ID	Title or contact	Reference or contact information
[1]		
[2]		

3.2 Action Item List

As the function is developed, identify issues that still need clarification, resolution, or other notice taken of them. This can act as an Action Item list.

ID	Description	Status
[1]		
[2]		

3.3 Revision History

For reference and tracking purposes, indicate who worked on describing this function, and what aspect they undertook.

No	Date	Author	Description
0.			

Wide-Area Wind Generation Forecasting

1 Descriptions of Function

All prior work (intellectual property of the company or individual) or proprietary (non-publicly available) work should be so noted.

1.1 Function Name

Wide-Area or Control Area Wind Generation Forecasting

1.2 Function ID

IECSA identification number of the function

M-5.1,G-2.2.1,G-2.2.2,G-2.2.3,G-2.2.4,G-2.2.5,G-3.2.1,G-3.2.2,G-3.2.3,G-3.8.1,G-3.8.2,G-4.4,G-4.5,G-5.1,G-5.3,C-7

1.3 Brief Description

Wind generation is primarily an energy resource, and cannot be dispatched like conventional generation. In more traditional utility operations, predictions of system load for the next hour, day, week, etc. are essential for deploying supply resources such as total costs are minimized while maintaining system reliability and security. Incremental costs due to the uncertainty in the timing and quantity of energy delivery from wind generation facilities in operational time frames can be reduced with better short-term wind generation forecasts and appropriate use of those predictions by control area operators and power markets in scheduling functions and real-time operating practices.

In situations where resource decisions are made by according to various market signals, prediction of wind generation will be important for those who operate the markets and are charged with responsibility for system security and reliability.

1.4 Narrative

Whether by direct action of an operating entity or in response to market signals, electric supply resources in an electric power control area must be managed, scheduled, and operated to provide for the desired levels of system reliability and security. Furthermore, to minimize the overall cost of electricity to consumers in the control area, the supply resources must be deployed in a manner that leads

to the lowest total production cost. Meeting these objectives and at the same time honoring the myriad constraints on individual generating units and resulting from contractual obligations requires the ability to continually assess the present state of the system and predict probable states hours or days in advance.

Uncertainty in the operational planning time frame can lead to defensive operating strategies and higher costs. Wind generation can only increase the uncertainty in the short-term forecasts utilized to commit and schedule generation, and may lead to higher operating costs. In real-time operation, additional reserves might be allocated to cover the uncertainty in the hours-ahead time frame, again with higher costs.

In control areas with multiple wind generation facilities, forecasts must be generated for each plant on schedules appropriate for real-time management of the control area as well as short-term operational planning activities such as unit commitment or reliability monitoring. Given that the plants in a single control area are exposed to the same general meteorological conditions, a wider geographical perspective on wind resource conditions for forecasting is essential. As a result, the stakeholder groups involved in wide-area wind generation forecasting are defined as follows:

- Operators of the individual wind plants
- Control area personnel responsible for “real-time” operations, i.e. within the hour and possibly for several hours ahead
- Control area personnel, which might include the power marketing functions, responsible for short-term planning activities, including unit commitment and scheduling, interchange scheduling, power purchases and sales, etc.
- Control area or RTO personnel responsible for monitoring system security, where generation dispatch decisions are made for technical reasons related to system integrity rather than economics
- A third party that produces forecasts of wind conditions and possibly wind generation for plants in the control area.

Individual wind plant operator

- Provides information on turbine availability and other plant status indications to forecasting entity
- Provides local meteorological information from plant sensors to forecasting entity
- Receives plant forecast information from forecasting entity

Real-time operators

- Receives wind generation forecast information from forecasting entity and utilizes for planning on an hours-ahead basis
- Receives notification from individual wind plant operators as to planned changes in status or availability
- Notifies individual plant operators of system conditions that may require certain actions on the part of the wind generation facility

PowerMarketer

- Receives wind generation forecasts from forecasting entity to make decisions about generating unit commitment and scheduling

Reliability and security monitors (RTO)

- Utilizes short-term wind generation forecast information to assess future system security and make decisions regarding remedial actions

Forecasting entity

- Collects meteorological information from public and private sensors
- Executes regional meteorological model to forecast wind speed for hours and days ahead
- Collects information from individual plant operators necessary to forecast production for plant
- Collects information from reliability monitors
- Develops wind generation forecast for individual plants and for aggregate wind generation in control area on the basis of wind plant information and wind speed forecasts
- Provides wind generation forecast to individual wind plant operators, real-time system operators, power marketers and reliability and security monitors (RTO)

1.5 Actor (Stakeholder) Roles

Describe all the people (their job), systems, databases, organizations, and devices involved in or affected by the Function (e.g. operators, system administrators, technicians, end users, service personnel, executives, SCADA system, real-time database, RTO, RTU, IED, power system). Typically, these actors are logically grouped by organization or functional boundaries or just for collaboration purpose of this use case. We need

to identify these groupings and their relevant roles and understand the constituency. The same actor could play different roles in different Functions, but only one role in one Function. If the same actor (e.g. the same person) does play multiple roles in one Function, list these different actor-roles as separate rows.

<i>Grouping (Community)</i>		<i>Group Description</i>
<i>Wind Forecasting Top Level Actors</i>		<i>Top Level Actors</i>
<i>Actor Name</i>	<i>Actor Type (person, device, system etc.)</i>	<i>Actor Description</i>
IndividualWindPlantOperator	Person or organization	<ul style="list-style-type: none"> • Provides information on turbine availability and other plant status indications to forecasting entity • Provides local meteorological information from plant sensors to forecasting entity • Receives plant forecast information from forecasting entity
Real time operators	Person or organization	<ul style="list-style-type: none"> • Receives wind generation forecast information from forecasting entity and utilizes for planning on an hours-ahead basis • Receives notification from individual wind plant operators as to planned changes in status or availability • Notifies individual plant operators of system conditions that may require certain actions on the part of the wind generation facility
PowerMarketer	Person or organization	<ul style="list-style-type: none"> • Receives wind generation forecasts from forecasting entity to make decisions about generating unit commitment and scheduling
Reliability and security monitors (RTO)	Person or organization	<ul style="list-style-type: none"> • Utilizes short-term wind generation forecast information to assess future system security and make decisions regarding remedial actions
Forecasting Entity	Person or organization	<ul style="list-style-type: none"> • Collects meteorological information from public and private sensors

<i>Grouping (Community)'</i>		<i>Group Description</i>
<i>Wind Forecasting Top Level Actors</i>		<i>Top Level Actors</i>
<i>Actor Name</i>	<i>Actor Type (person, device, system etc.)</i>	<i>Actor Description</i>
		<ul style="list-style-type: none"> • Executes regional meteorological model to forecast wind speed for hours and days ahead • Collects information from individual plant operators necessary to forecast production for plant • Collects information from reliability monitors (RTO) • Develops wind generation forecast for individual plants and for aggregate wind generation in control area on the basis of wind plant information and wind speed forecasts • Provides wind generation forecast to individual wind plant operators, real-time system operators, and power marketers
SensorDevice	Device	<ul style="list-style-type: none"> • Provides meteorological data etc. to forecasting entity

Replicate this table for each logic group.

1.6 Information exchanged

Describe any information exchanged in this template.

<i>Information Object Name</i>	<i>Information Object Description</i>
Sensor data	Data from sensors used to create forecasts
Local data	Local turbine and sensor data from wind plant operators

<i>Information Object Name</i>	<i>Information Object Description</i>
Wind generation forecasts	Forecasts of wind generator

1.7 Activities/Services

Describe or list the activities and services involved in this Function (in the context of this Function). An activity or service can be provided by a computer system, a set of applications, or manual procedures. These activities/services should be described at an appropriate level, with the understanding that sub-activities and services should be described if they are important for operational issues, automation needs, and implementation reasons. Other sub-activities/services could be left for later analysis.

<i>Activity/Service Name</i>	<i>Activities/Services Provided</i>
Wind generation forecast	Provides forecast of wind generation to be used by various entities

1.8 Contracts/Regulations

Identify any overall (human-initiated) contracts, regulations, policies, financial considerations, engineering constraints, pollution constraints, and other environmental quality issues that affect the design and requirements of the Function.

<i>Contract/Regulation</i>	<i>Impact of Contract/Regulation on Function</i>

<i>Policy</i>	<i>From Actor</i>	<i>May</i>	<i>Shall Not</i>	<i>Shall</i>	<i>Description (verb)</i>	<i>To Actor</i>

--	--	--	--	--	--	--

<i>Constraint</i>	<i>Type</i>	<i>Description</i>	<i>Applies to</i>

2 Step by Step Analysis of Function

Describe steps that implement the function. If there is more than one set of steps that are relevant, make a copy of the following section grouping (Preconditions and Assumptions, Steps normal sequence, and Steps alternate or exceptional sequence, Post conditions)

2.1 Steps to implement function

Name of this sequence.

2.1.1 Preconditions and Assumptions

Describe conditions that must exist prior to the initiation of the Function, such as prior state of the actors and activities

Identify any assumptions, such as what systems already exist, what contractual relations exist, and what configurations of systems are probably in place

Identify any initial states of information exchanged in the steps in the next section. For example, if a purchase order is exchanged in an activity, its precondition to the activity might be 'filled in but unapproved'.

<i>Actor/System/Information/Contract</i>	<i>Preconditions or Assumptions</i>
IndividualWindPlantOperators	Has turbines ready to operate and has provided sufficient information for operators to calculate forecasts, etc.

2.1.2 Steps – Normal Sequence

Describe the normal sequence of events, focusing on steps that identify new types of information or new information exchanges or new interface issues to address. Should the sequence require detailed steps that are also used by other functions, consider creating a new “sub” function, then referring to that “subroutine” in this function. Remember that the focus should be less on the algorithms of the applications and more on the interactions and information flows between “entities”, e.g. people, systems, applications, data bases, etc. There should be a direct link between the narrative and these steps.

The numbering of the sequence steps conveys the order and concurrency and iteration of the steps occur. Using a Dewey Decimal scheme, each level of nested procedure call is separated by a dot ‘.’. Within a level, the sequence number comprises an optional letter and an integer number. The letter specifies a concurrent sequence within the next higher level; all letter sequences are concurrent with other letter sequences. The number specifies the sequencing of messages in a given letter sequence. The absence of a letter is treated as a default ‘main sequence’ in parallel with the lettered sequences.

Sequence 1:

*1.1 - Do step 1
1.2A.1 - In parallel to activity 2 B do step 1
1.2A.2 - In parallel to activity 2 B do step 2
1.2B.1 - In parallel to activity 2 A do step 1
1.2B.2 - In parallel to activity 2 A do step 2
1.3 - Do step 3
1.3.1 - nested step 3.1
1.3.2 - nested step 3.2*

Sequence 2:

*2.1 - Do step 1
2.2 - Do step 2*

#	Event	Primary Actor	Name of Process/Activity	Description of Process/Activity	Information Producer	Information Receiver	Name of Info Exchanged	Additional Notes	IECSA Environments
#	<i>Triggering event? Identify the name of the event.¹</i>	<i>What other actors are primarily responsible for the Process/Activity? Actors are defined in section 1.5.</i>	<i>Label that would appear in a process diagram. Use action verbs when naming activity.</i>	<i>Describe the actions that take place in active and present tense. The step should be a descriptive noun/verb phrase that portrays an outline summary of the step. "If ...Then...Else" scenarios can be captured as multiple Actions or as separate steps.</i>	<i>What other actors are primarily responsible for Producing the information? Actors are defined in section 1.5.</i>	<i>What other actors are primarily responsible for Receiving the information? Actors are defined in section 1.5. (Note – May leave blank if same as Primary Actor)</i>	<i>Name of the information object. Information objects are defined in section 1.6</i>	<i>Elaborate architectural issues using attached spreadsheet. Use this column to elaborate details that aren't captured in the spreadsheet.</i>	<i>Reference the applicable IECSA Environment containing this data exchange. Only one environment per step.</i>
1.1	Provide Data	IndividualWindPlantOperator	Provide Data	IndividualWindPlantOperator provides information on turbine availability and local sensor data to forecasting entity	IndividualWindPlantOperator	Forecasting Entity	Local Data		Control Center / Corporations
1.2	Collect Sensor Data	SensorDevice	Collect Sensor Data	Forecasting entity collects meteorological data from public and private sensors	SensorDevice	Forecasting Entity	Sensor Data		Lower Security DAC
1.3	Make Forecast	Forecasting Entity	Make Forecast	Forecasting entity runs models and creates forecast	Forecasting Entity	IndividualWindPlantOperators, PowerMarket er, Real time operators, Reliability and Security Monitors (RTO)	Wind Generation Forecasts		Control Center / Corporations

¹ Note – A triggering event is not necessary if the completion of the prior step – leads to the transition of the following step.

2.1.3 Steps – Alternative / Exception Sequences

Describe any alternative or exception sequences that may be required that deviate from the normal course of activities. Note instructions are found in previous table.

#	Event	Primary Actor	Name of Process/Activity	Description of Process/Activity	Information Producer	Information Receiver	Name of Info Exchanged	Additional Notes	IECSA Environments

2.1.4 Post-conditions and Significant Results

Describe conditions that must exist at the conclusion of the Function. Identify significant items similar to that in the preconditions section.

Describe any significant results from the Function

<i>Actor/Activity</i>	<i>Post-conditions Description and Results</i>
IndividualWindPlantOperators	Has turbines ready to operate and has provided sufficient information for operators to calculate forecasts, etc.

2.2 Architectural Issues in Interactions

Elaborate on all architectural issues in each of the steps outlined in each of the sequences above. Reference the Step by number..

Diagram

For clarification, draw (by hand, by Power Point, by UML diagram) the interactions, identifying the Steps where possible.

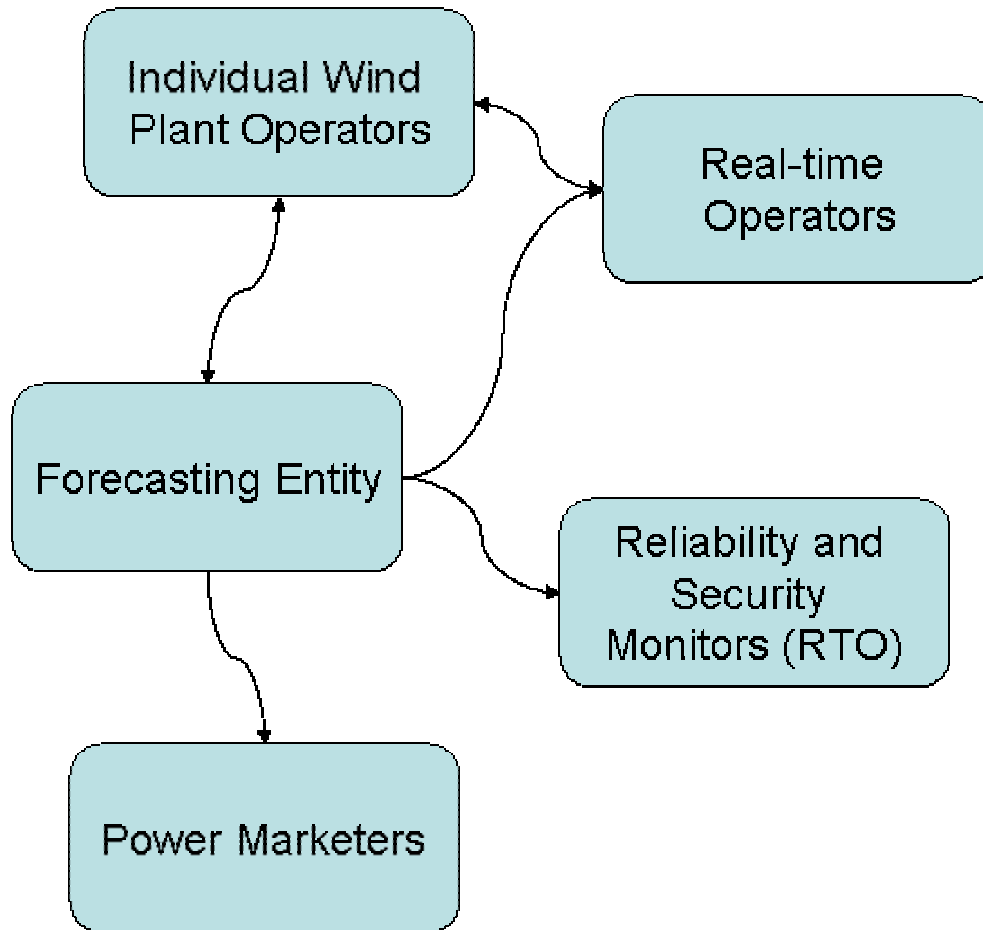

3 Auxiliary Issues

3.1 References and contacts

Documents and individuals or organizations used as background to the function described; other functions referenced by this function, or acting as “sub” functions; or other documentation that clarifies the requirements or activities described. All prior work (intellectual property of the company or individual) or proprietary (non-publicly available) work must be so noted.

ID	Title or contact	Reference or contact information
[1]		
[2]		

3.2 Action Item List

As the function is developed, identify issues that still need clarification, resolution, or other notice taken of them. This can act as an Action Item list.

ID	Description	Status
[1]		
[2]		

3.3 Revision History

For reference and tracking purposes, indicate who worked on describing this function, and what aspect they undertook.

No	Date	Author	Description
0.			

Functional Requirements for Advanced Distribution Automation with DER (ADA-DER)

1	Descriptions of Function.....	1
1.1	Function Name.....	1
1.2	Function ID	1
1.3	Brief Description	1
1.4	Narrative	2
1.4.1	Overview of ADA Functions	2
1.4.1.1	Overview Diagrams	2
1.4.1.2	Overall Preconditions.....	5
1.4.1.3	Overview of Post Conditions	6
1.4.2	Distribution Operation Modeling and Analysis (DOMA).....	7
1.4.2.1	Modeling Transmission/Sub-Transmission System Immediately Adjacent to Distribution Circuits.....	8
1.4.2.2	Modeling Distribution Circuit Connectivity.....	8
1.4.2.3	Modeling Distribution Nodal Loads	9
1.4.2.4	Modeling Distribution Circuit Facilities.....	9
1.4.2.5	Distribution Power Flow.....	9
1.4.2.6	Evaluation of Transfer Capacity	9
1.4.2.7	Power Quality Analysis	10
1.4.2.8	Loss Analysis	10
1.4.2.9	Fault Analysis	10
1.4.2.10	Evaluation of Operating Conditions	10
1.4.3	Fault Location, Isolation and Service Restoration (FLIR).....	11

1.4.3.1	Fault Location	11
1.4.3.2	Fault Isolation and Service Restoration	11
1.4.4	Contingency Analysis (CA).....	11
1.4.5	Multi-level Feeder Reconfiguration (MFR).....	12
1.4.6	Relay Protection Re-coordination (RPR).....	12
1.4.7	Voltage and Var Control (VVC).....	13
1.4.8	Pre-arming of Remedial Action Schemes (RAS)	13
1.4.9	Coordination of Emergency Actions	14
1.4.10	Coordination of Restorative Actions	14
1.4.11	Intelligent Alarm Processing.....	14
1.5	Actor (Stakeholder) Roles	14
1.6	Information exchanged	19
1.7	Activities/Services.....	23
1.8	Contracts/Regulations	25
2	Step by Step Analysis of Function.....	28
2.1	Distribution Operation Modeling and Analysis (DOMA) Function.....	28
2.1.1	DOMA Preconditions and Assumptions.....	28
2.1.2	DOMA Steps – Normal Sequence	29
2.1.2.1	Data Conversion and Validation.....	30
2.1.2.2	DOMA No Events.....	39
2.1.2.3	DOMA Event Run	41
2.1.2.4	DOMA Scheduled Run	48
2.1.2.5	DOMA Study/Look-ahead Mode	52

2.1.3 Steps – Alternative / Exception Sequences.....	57
2.1.4 Post-conditions and Significant Results.....	58
2.1.5 Diagrams	58
2.2 Fault Location, Isolation and Service Restoration (FLIR) Function	64
2.2.1 FLIR Preconditions and Assumptions	64
2.2.2 FLIR Steps – Normal Sequence.....	65
2.2.2.1 FLIR First Fault with Only Manual Switches.....	66
2.2.2.2 FLIR Second Fault (Related to First Fault which is Not Resolved Yet) with Only Manual Switches	72
2.2.2.3 FLIR Fault with Remotely-Controlled and Manual Switches	87
2.2.2.4 FLIR Fault with Remotely-Controlled and Manual Switches and Distributed Intelligence System (DIS).....	97
2.2.2.5 FLIR Fault with DER Connected to Healthy Section.....	108
2.3.1 Post-conditions and Significant Results.....	113
2.3.2 Diagrams	113
2.3 Volt/Var Control function (VVC).....	119
2.3.1 VVC Preconditions and Assumptions	119
2.3.2 VVC Steps – Normal Sequence.....	120
2.3.2.1 VVC Function During Scheduled Run	121
2.3.2.2 VVC Function During Event Run.....	124
2.3.2.3 VVC Function Participation in Severe Emergency in Bulk Power System with Intentional Islands.....	133
2.3.3 Post-conditions and Significant Results.....	136
2.3.4 Diagrams	137
2.4 Architectural Issues in Interactions	140
2.5 Current Implementation Status	141

3	Auxiliary Issues	142
3.1	References and Contacts	142
3.1.1	Prior Published Work of UCI and UCI's Personnel	142
3.2	Action Item List	145
3.3	Revision History	147

Functional Requirements for Advanced Distribution Automation with DER (ADA-DER) Advanced Distribution Automation with DER (ADA-DER) Function Use Case Description¹

1 Descriptions of Function

All prior work (intellectual property of the company or individual) or proprietary (non-publicly available) work should be so noted.

1.1 Function Name

Name of Function

The function (further referred as Function) is named **Advanced Distribution Automation (ADA) Function**.

1.2 Function ID

IECSA identification number of the function

L-3,L-3.1,L-3.2,L-3.3,L-3.4,L-3.5,L-3.6,L-3.8,L-3.9

1.3 Brief Description

Describe briefly the scope, objectives, and rationale of the Function.

Objective: The objective of Advanced Distribution Automation Function is to enhance the reliability of power system service, power quality, and power system efficiency, by automating the following three processes of distribution operation control: data preparation in near-real-time; optimal decision-making; and the control of distribution operations in coordination with transmission and generation systems operations.

Scope: The AdvancedDistributionAutomationSystem Function performs a) data gathering, along with data consistency checking and correcting; b) integrity checking of the distribution power system model; c) periodic and event-driven system modeling and analysis; d) current and predictive alarming; e) contingency analysis; f) coordinated volt/var optimization; g) fault location, isolation, and service restoration; h) multi-level feeder reconfiguration; i) pre-arming of RAS and coordination of emergency actions in distribution; j) pre-arming of restoration schemes and coordination of restorative actions in distribution, and k) logging and reporting. These processes are performed through direct interfaces with different databases and systems, (EMS, OMS, CIS, MOS, SCADA,

¹ Background information includes prior UCI work

AM/FM/GIS, AMS and WMS), comprehensive near real-time simulations of operating conditions, near real-time predictive optimization, and actual real-time control of distribution operations.

Rationale: By meeting its objectives in near-real time, the Function makes a significant contribution to improving the power system operations through automation, which cannot be achieved using existing operational methods.

Status: The methodology and specification of the Function for current power system conditions have been developed, and prototype (pilot) and system-wide project in several North-American utilities have been implemented by Utility Consulting International and its client utilities prior to the IECSA project.

1.4 Narrative

A complete narrative of the Function from a Domain Expert's point of view, describing what occurs when, why, how, and under what conditions. This will be a separate document, but will act as the basis for identifying the Steps in Section 2.

1.4.1 Overview of ADA Functions

The AdvancedDistributionAutomationSystem Function operates via the following closely coordinated applications:

1.4.1.1 Overview Diagrams

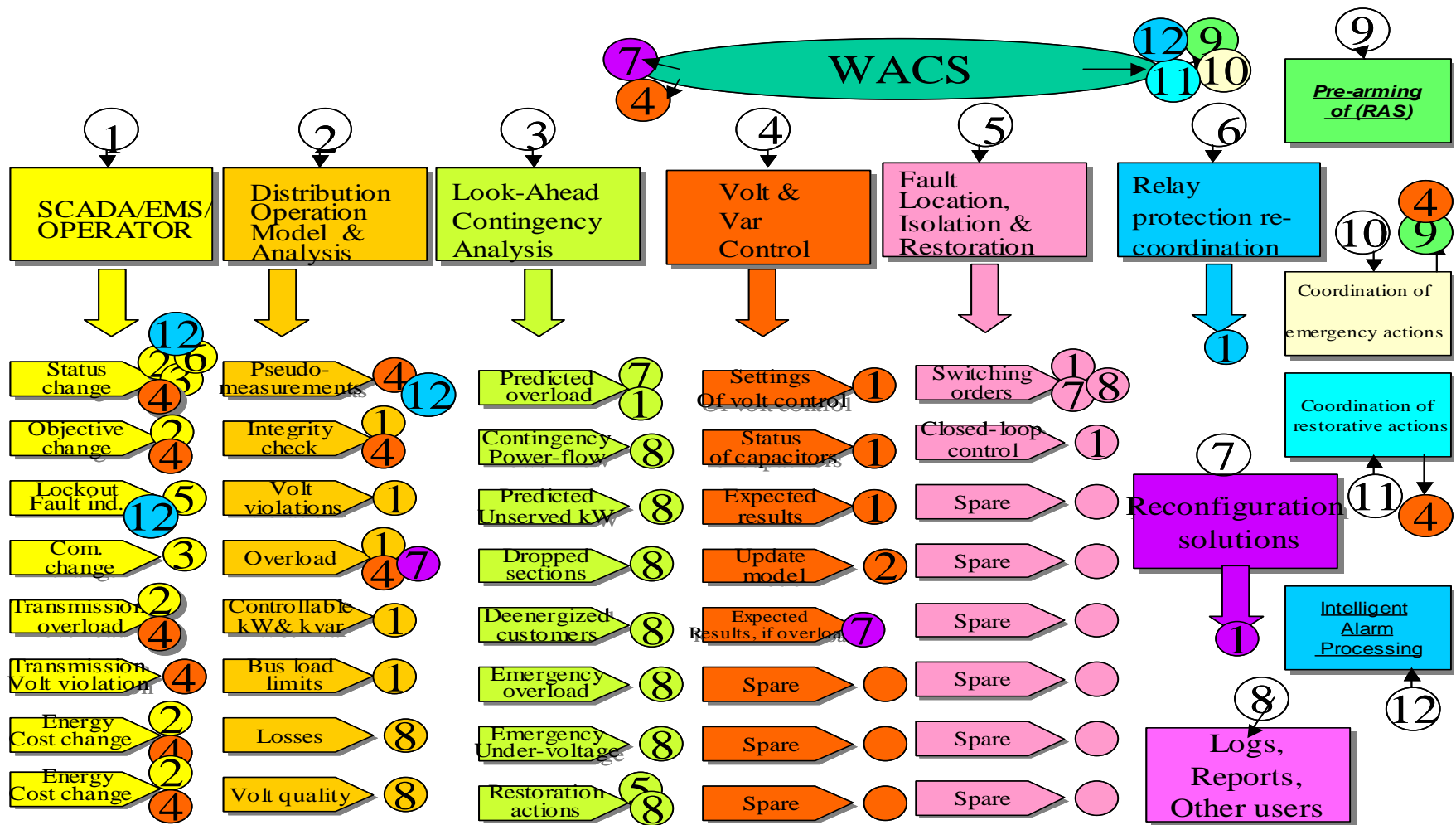

Fig. 1 Coordination of ADA applications is accomplished through internal interfaces within the ADA function and through the feedback from the power system.

Real-Time Distribution Operations showing Interactions and Information Flows

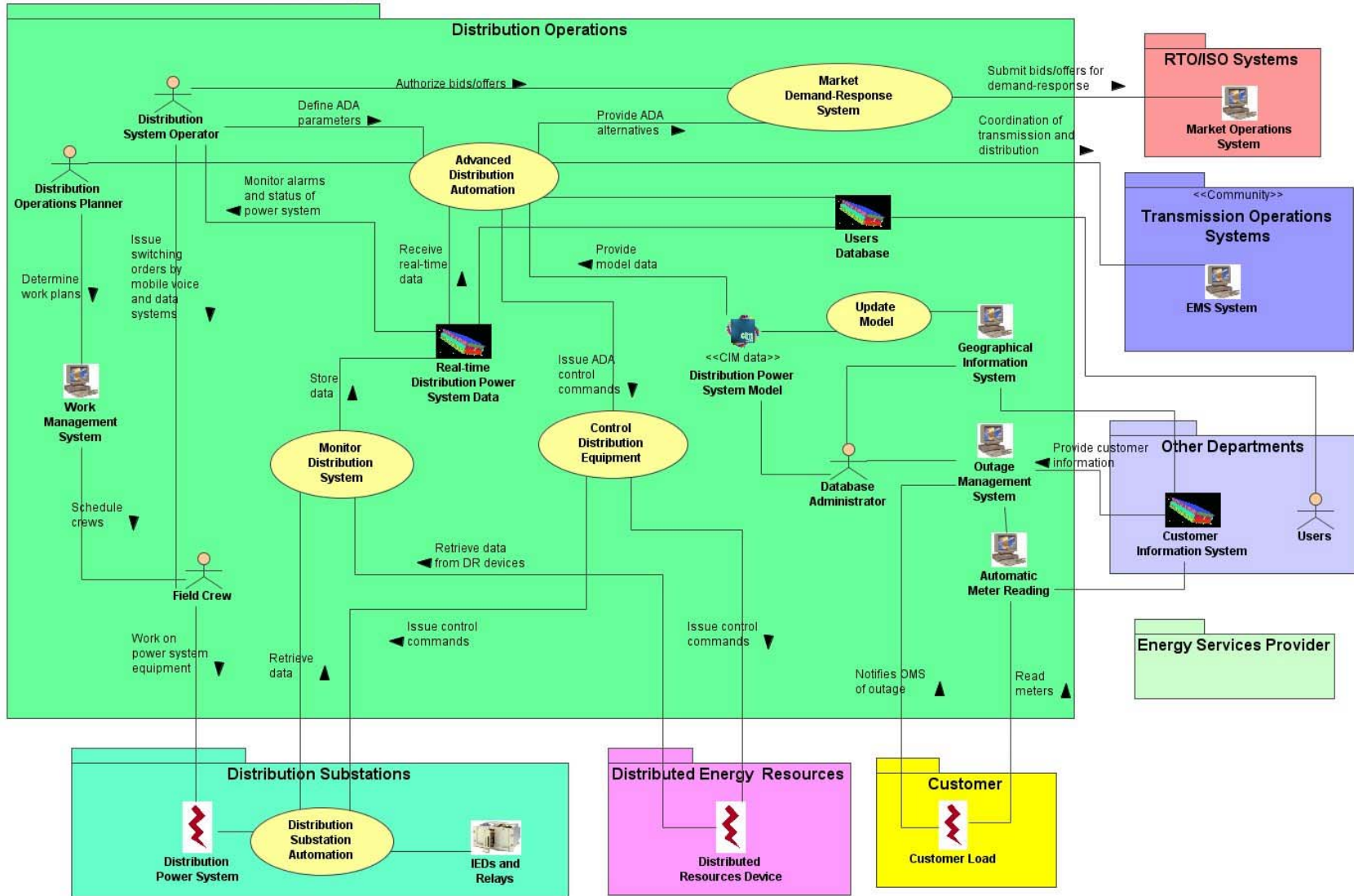

Fig. 2 – {Not yet coordinated with the Use Case description}

1.4.1.2 Overall Preconditions

<i>Actor/System/Contract</i>	<i>Preconditions or Assumptions</i>
DistributionSCADASystem	DistributionSCADASystem database is updated via remote monitoring and operator inputs. Required scope, speed, and accuracy of real-time measurements are provided, supervisory and closed-loop control is supported.
AM_FM_GISDatabase	AM/FM system contains the geographical information of the distribution power system circuit connectivity, as well as the parameters describing the power system facilities. Conceptually, the AM_FM_GISDatabase can contain transmission connectivity and facility data and relevant to distribution operations customer-related data.
CIS database	CIS contains load data for customers that is estimated for each nodal location on a feeder, based on billing data and time-of-day and day-of week load shapes for different load categories.
SCADA/EnergyManagementSystem	EnergyManagementSystem system contains the transmission power system model, and can provide the transmission connectivity information for facilities in the vicinity of the distribution power system facilities and with outputs from other EnergyManagementSystem applications
ConversionValidationFunction	The C&V function uses standard interface between AM_FM_GISDatabase and converts and validates information about incremental changes implemented in the field.
ADADistributionOperationModeling and Analysis (DOMA)	Preconditions: DistributionSCADASystem with several IEDs along distribution feeders, reporting statuses of remotely controlled switches and analogs including Amps, kW, kvar, and kV. Regional System Operator's ability for updating the SCADA database with statuses of switches not monitored remotely. Substation SCADA with analogs and statuses from CBs exists. EnergyManagementSystem is interfaced with AdvancedDistributionAutomationSystem. AdvancedDistributionAutomationSystem database is updated with the latest AM/FM/GIS/CIS data and operators input. The options for DOMA performance are selected
AdvancedDistributionAutomationSystem: Fault Location Isolation and Service Restoration (FLIR)	<u>Fault Location</u> Preconditions: DistributionSCADASystem with fault detectors, Distribution Operation Model and Analysis with fault analysis, fault location relays (schemes) including high impedance relays and Some Distributed Intelligence schemes and Trouble call system exist. <u>Fault Isolation and Service Restoration</u> Preconditions: DistributionSCADASystem with ability to control a defined number of switching devices, Fault Location, Distribution Operation Model and Analysis, Voltage and Var Control for adjusting voltage and var after reconfiguration. Supervisory and closed-loop control of switches are available. Some Distributed Intelligence schemes exist. .
AdvancedDistributionAutomationSystem: Contingency Analysis (CA)	The AdvancedDistributionAutomationSystem database is updated including the real-time state of communication with IEDs and the availability of switch control. The options for CA are selected.
AdvancedDistributionAutomationSystem: Multi-level Feeder Reconfiguration (MFR)	Preconditions: DistributionSCADASystem with ability to control a definite number of switching devices, Distribution Operation Model and Analysis, Voltage and Var Control for adjusting voltage and var after reconfiguration. Supervisory and closed-loop control of switches are available. The options for the application are selected.
AdvancedDistributionAutomationSystem: Relay Protection Re-coordination (RPR)	The settings and modes of operation of the switching devices are reported by SCADA and can be controlled via SCADA.

<i>Actor/System/Contract</i>	<i>Preconditions or Assumptions</i>
ADAVVCController	Preconditions: DistributionSCADASystem, Distribution Operation Model and Analysis, capability to monitor and control all or a portion of voltage, capacitor, DER, and power electronic controllers in closed-loop mode exist.
AdvancedDistributionAutomationSystem: Prearming of Remedial Action Schemes (RAS)	Preconditions: AdvancedDistributionAutomationSystem is interfaced with the RAS schemes with the capability of changing the priorities of RAS actions and settings
ADAEmergencyCoordinationSystem (CEA)	Preconditions: AdvancedDistributionAutomationSystem is interfaced with EnergyManagementSystem and receives critical statuses, measurements, preventive and corrective actions
ADARestorationCoordinationSystem (CRA)	Preconditions: AdvancedDistributionAutomationSystem is interfaced with EnergyManagementSystem and receives information about restoration conditions
AdvancedDistributionAutomationSystem: Intelligent Alarm Processing (IAP)	Preconditions: AdvancedDistributionAutomationSystem receives synchronized (time stamped) status and analog data from IEDs including uploads from event recorders.
Distributed Intelligence Schemes	Preconditions: Distribution Intelligence Schemes are equipped with peer-to-peer communications and interfaced with AdvancedDistributionAutomationSystem for pre-arming and coordination.
LoadManagmentDevice (LMS)	Preconditions: LMS is interfaced with AdvancedDistributionAutomationSystem, can be prioritized by AdvancedDistributionAutomationSystem
UFLS: Under-Frequency Load Shedding Schemes	Preconditions: UFLS is interfaced with AdvancedDistributionAutomationSystem, can be prioritized and pre-armed by AdvancedDistributionAutomationSystem
UVLS: Under-Voltage Load Shedding Schemes	Preconditions: UVLS is interfaced with AdvancedDistributionAutomationSystem, can be prioritized and pre-armed by AdvancedDistributionAutomationSystem
SLS: Special Load Shedding Schemes	Preconditions: SLS is interfaced with AdvancedDistributionAutomationSystem, can be prioritized and pre-armed by AdvancedDistributionAutomationSystem

1.4.1.3 Overview of Post Conditions

<i>Actor/Activity</i>	<i>Post-conditions Description and Results</i>
SCADA Distribution	Works continuously
ADADistributionOperationModeling and Analysis	All details of the real-time unbalanced distribution power flow are available for engineering review. The operator is provided with the summary of analysis. Other applications receive the pseudo-measurements for each distribution system element down to load centers in the secondaries practically replacing hundreds thousands of measurements. The database is updated via real-time topology data. The observability of distribution operating conditions is increased multifold. The dynamic voltage limits are calculated; aggregated load models for EnergyManagementSystem are provided; dispatchable load is estimated.
AdvancedDistributionAutomation	Faulted section is identified. A solution for an optimal isolation of faulted portions of

<i>Actor/Activity</i>	<i>Post-conditions Description and Results</i>
System: Fault Location Isolation and Service Restoration	distribution feeder and restoration of services to healthy portions is provided to the operator; closed-loop execution of switching orders is available; Outage time for the majority of customers is reduced to several minutes.
AdvancedDistributionAutomation System: Contingency Analysis	Results of contingency analysis of the relevant portion of distribution system are provided for engineering review and for use by other applications. Expected overload is determined; solutions are recommended. Planned outages are better prepared.
AdvancedDistributionAutomation System: Multi-level Feeder Reconfiguration	Optimal selection of feeder(s) connectivity for a given objective is provided to the operator; Closed-loop execution is available. Reliability is increased, losses are reduced, voltages are improved; room for voltage optimization is increased; utilization of distribution facilities is enhanced;
AdvancedDistributionAutomation System: Relay Protection Re-coordination	Relay protection settings adjusted to the real-time conditions based on the preset rules are sent to relevant protective relaying. The relay coordination is adaptive to the real-time condition; the reliability of service is increased.
AdvancedDistributionAutomation System: Voltage and Var Control	Optimal voltage controller and DER controller settings and capacitor statuses for a given objective(s) are sent to respective devices. The power quality is enhanced; The distribution facilities are better utilized; the transmission and generation systems is better supported by volt and vars; the load management is less intrusive; the customers pay smaller bills.

1.4.2 Distribution Operation Modeling and Analysis (DOMA)

This application is based on a real-time unbalanced distribution power flow for dynamically changing distribution operating conditions. It analyzes the results of the power flow simulations and provides the operator with the summary of this analysis. It further provides other applications with pseudo-measurements for each distribution system element from within substations down to load centers in the secondaries. The model is kept up-to-date by real-time updates of topology, facilities parameters, load, and relevant components of the transmission system.

The Distribution Operation Modeling and Analysis supports three modes of operation:

1. Real-time mode, which reflects present conditions in the power system.
2. Look-ahead mode, which reflects conditions expected in the near future (from one hour to one week ahead)
3. Study mode, which provides the capability of performing the “what if” studies.

The key sub-functions performed by the application are as follows:

1.4.2.1 Modeling Transmission/Sub-Transmission System Immediately Adjacent to Distribution Circuits

This sub-function provides topology and electrical characteristics of those substation transformers and transmission/sub-transmission portions of the system, where loading and voltage levels significantly depend on the operating conditions of the particular portion of the distribution system. The model also includes substation transformers and transmission/sub-transmission lines with load and voltage limits that should be respected by the application.

1.4.2.2 Modeling Distribution Circuit Connectivity

This sub-function provides a topological model of distribution circuits, starting from the distribution side of the substation transformer and ending at the equivalent load center on the secondary of each distribution transformer. A topological consistency check is performed every time connectivity changes. The model input comes from SCADA/EnergyManagementSystem, DistributionSCADASystem, from field crews, from DISCO operator, from AM/FM/GIS, WorkManagementSystem, and OutageManagementSystem databases, and engineers.

- **Data Management Issues between AM/FM/GIS and AdvancedDistributionAutomationSystem Distribution Connectivity Database**

Standard interfaces between different AM_FM_GISDatabases, data converters, and AdvancedDistributionAutomationSystem database are not developed yet for practical use. The AM_FM_GISDatabases were not designed for real-time operational use. They lack many objects and attributes needed for AdvancedDistributionAutomationSystem. The population of the databases is not supported by an interactive consistency check. The existing extractors of data and the converters into AdvancedDistributionAutomationSystem databases do not determine all data errors. The AdvancedDistributionAutomationSystem applications must conduct additional data consistency checking and data corrections before recommendations and controls are issued. Typically utility do not have established procedures for regular update of the AM_FM_GISDatabases by the operation and maintenance personnel. Therefore many changes implemented in the field remain unnoticed by the databases. Synchronization of the field state with the AdvancedDistributionAutomationSystem database is a challenge in modern utilities.

- **Data Management Issues between CIS and AM/FM/GIS and AdvancedDistributionAutomationSystem Distribution Connectivity Database**

For the AdvancedDistributionAutomationSystem applications, the AM/FM/GIS data must be associated with the corresponding customer information data from the CIS database. This data include billing data and description of the customer specifics, such as rate schedule, customer code, meter number, address, etc. The critical information is the billing data. This data is updated based on metering cycles (typically one month) and is not well synchronized. In order to synchronize billing data an automated meter reading system should be implemented. In order to update the AdvancedDistributionAutomationSystem databases more frequently, which would increase the resolution of AdvancedDistributionAutomationSystem functions to individual distribution transformers and even customers, a high capacity communication system should be introduced to gather the data from hundreds of thousands of meters at the same time. Some of the modern procedures enabled by AutomatedMeterReadingDevice conflict with the needs of AdvancedDistributionAutomationSystem model. An example is the consolidated bills, where the individual load data of distribution transformers located in different sites of the consolidated company becomes unavailable for the external to CIS world.

1.4.2.3 Modeling Distribution Nodal Loads

This sub-function provides characteristics of real and reactive load connected to secondary side of distribution transformer or to primary distribution circuit in case of primary meter customers. These characteristics are sufficient to estimate kW and kvars at a distribution node at any given time and day and include the load shapes and load-to-voltage sensitivities (for real and reactive power) of various load categories. In real-time mode, the nodal loads are balanced with real-time measurements obtained from corresponding primary circuits. A validity check is applied to real-time measurements. The load model input comes from DistributionSCADA System, from CIS supported by AutomatedMeterReadingDevice and linked with AM/FM/GIS, and weather forecast systems.

1.4.2.4 Modeling Distribution Circuit Facilities

This sub-function models the following distribution circuit facilities:

1. Overhead and underground line segments
2. Switching devices
3. Substation and distribution transformers, including step-down transformers
4. Station and feeder capacitors and their controllers
5. Feeder series reactors
6. Voltage regulators (single- and three-phase) and their controllers
7. LTC's and their controllers
8. Distribution generators and synchronous motors
9. Load equivalents for higher frequency models

All facilities should be modeled with sufficient details to support the required accuracy of Distribution Operation Modeling and Analysis application.

1.4.2.5 Distribution Power Flow

The sub-function models the power flow including the impact of automatically controlled devices (i.e., LTCs, capacitor controllers, voltage regulators), and solves both radial and meshed networks, including those with multiple supply busses (i.e. having Distributed Energy Resources (DER) interconnected to the power system).

1.4.2.6 Evaluation of Transfer Capacity

This sub-function estimates the available bi-directional transfer capacity for each designated tie switch. The determined transfer capacity is such that the loading of a tie switch does not lead to any voltage or current violations along the interconnected feeders.

1.4.2.7 Power Quality Analysis

This sub-function performs the power quality analysis by:

1. Comparing (actual) measured and calculated voltages against the limits
2. Determining the portion of time the voltage or imbalance are outside the limits
3. Determining the amount of energy consumed during various voltage deviations and imbalance
4. Recording the time when voltage violations occur
5. Performing modeling of higher harmonics propagation and resonant conditions based on information available from the sources of harmonic distortion
6. Performing modeling of rapid voltage changes based on information available from the sources of voltage distortion

The sub-function provides the ability to estimate the expected voltage quality parameters during the planned changes in connectivity and reactive power compensation.

1.4.2.8 Loss Analysis

This sub-function bases its analysis on technical losses (e.g., conductor I^2R losses, transformer load and no-load losses, and dielectric losses) calculated for different elements of the distribution system (e.g., per feeder or substation transformer). For the defined area, these losses are accumulated for a given time interval (month, quarter, year, etc.). They are further compared with the difference between the energy input (based on measurements) into the defined area and the total of relevant billed kWh (obtained from the database), normalized to the same time interval. The result of the comparison is an estimate of commercial losses (e.g., metering errors and theft).

1.4.2.9 Fault Analysis

This sub-function calculates three-phase, line-to-line-to-ground and line-to-ground fault currents for each protection zone associated with feeder circuit breakers and field reclosers. The minimum fault current is compared with protection settings while the maximum fault current is compared with interrupting ratings of breakers and reclosers. If the requirements are not met, a message is generated for the operator.

1.4.2.10 Evaluation of Operating Conditions

This sub-function determines the difference between the existing substation bus voltage and the substation bus voltages limits. The sub-function also estimates the available dispatchable real and reactive load obtainable via volt/var control. The operator or other applications can use this information for selective load reduction. The sub-function provides aggregated operational parameters for the transmission buses to be used in transmission operation models.

1.4.3 Fault Location, Isolation and Service Restoration (FLIR)

This application detects the fault, determines the faulted section and the probable location of fault, and recommends an optimal isolation of the faulted portions of the distribution feeder and the procedures for the restoration of services to its healthy portions. The key sub-functions performed by the application are as follows:

1.4.3.1 Fault Location

This sub-function is initiated by SCADA inputs, such as lockouts, fault indications/location, and, also, by inputs from OutageManagementSystem, and, in the future, by inputs from fault-predicting devices. It determines the specific protective device, which has cleared the sustained fault, identifies the de-energized sections, and estimates the probable place of the actual or the expected fault. It distinguishes faults cleared by controllable protective devices from those cleared by fuses, and identifies momentary outages and inrush/cold load pick-up currents.

1.4.3.2 Fault Isolation and Service Restoration

This sub-function supports three modes of operation:

1. Closed-loop mode, in which the sub-function is initiated by the Fault location sub-function. It generates a switching order (i.e., sequence) for the remotely controlled switching devices to isolate the faulted section, and restore service to the non-faulted sections. The switching order is automatically executed via SCADA. .
2. Advisory mode, in which the sub-function is initiated by the Fault location sub-function. It generates a switching order for remotely- and manually-controlled switching devices to isolate the faulted section, and restore service to the non-faulted sections. The switching order is presented to operator for approval and execution
3. Study mode, in which the sub-function is initiated by the user. It analyzes a saved case modified by the user, and generates a switching order under the operating conditions specified by the user.

If during execution, there is change in connectivity, the sub-function interrupts the execution and re-optimizes the solution based on new conditions. If during service restoration, there is another fault, the sub-function runs again considering a new fault scenario. When work is completed, the sub-function is instructed to generate a switching order for restoration of the normal configuration. The generated switching orders are based on considering the availability of remotely controlled switching devices, feeder paralleling, creation of islands supported by distributed energy resources, and on cold-load pickup currents.

1.4.4 Contingency Analysis (CA)

This application performs an N-m contingency analysis in the relevant portion of distribution. The function runs in the following manners:

1. Periodically

2. By event (topology change, load change, availability of control change)
3. Study mode, in which the conditions are defined and the application is started by the user.

The application informs the operator on the status of real-time distribution system reliability.

1.4.5 Multi-level Feeder Reconfiguration (MFR)

This application recommends an optimal selection of feeder(s) connectivity for different objectives. It supports three modes of operation:

1. Closed-loop mode, in which the application is initiated by the Fault Location, Isolation and Service Restoration application, unable to restore service by simple (one-level) load transfer, to determine a switching order for the remotely-controlled switching devices to restore service to the non-faulted sections by using multi-level load transfers. .
2. Advisory mode, in which the application is initiated by SCADA alarms triggered by overloads of substation transformer, segments of distribution circuits, or by DEMA detecting an overload, or by operator who would indicate the objective and the reconfiguration area. In this mode, the application recommends a switching order to the operator.
3. Study mode, in which the application is initiated and the conditions are defined by the user.

The application performs a multi-level feeder reconfiguration to meet one of the following objectives:

- a. Optimally restore service to customers utilizing multiple alternative sources. The application meets this objective by operating as part of Fault Location, Isolation and Service Restoration.
- b. Optimally unload an overloaded segment. This objective is pursued if the application is triggered by the overload alarm from SCADA, or from the Distribution Operation Modeling and Analysis, or from Contingency analysis. These alarms are generated by overloads of substation transformer or segments of distribution circuits, or by operator demand.
- c. Minimize losses
- d. Minimize exposure to faults
- e. Equalize voltages

The last three objectives are selected by engineer/planner.

1.4.6 Relay Protection Re-coordination (RPR)

This application adjusts the relay protection settings to real-time conditions based on the preset rules. This is accomplished through analysis of relay protection settings and operational mode of switching devices (i.e., whether the switching device is in a switch or in a recloser mode), while considering the real-time connectivity, tagging, and weather conditions. The application is called to perform after feeder reconfiguration, and, in case, when conditions are changed and fuse saving is required.

1.4.7 Voltage and Var Control (VVC)

This application calculates the optimal settings of voltage controller of LTCs, voltage regulators, DERs, power electronic devices, and capacitor statuses optimizing the operations by either following different objectives at different times, or considering conflicting objectives together in a weighted manner.

It supports three modes of operation:

1. Closed-loop mode, in which the application runs either periodically (e.g., every 15 min) or is triggered by an event (i.e., topology or objective change), based on real-time information. The application's recommendations are executed automatically via SCADA control commands.
2. Study mode, in which the application performs "what-if" studies, and provides recommended actions to the operator.
3. Look-ahead mode, in which conditions expected in the near future can be studied (from 1 hour through 1 week) by the operator.

The following objectives, which could be preset for different times of the day and overwritten by operator if need to, are supported by the application:

- a. Minimize kWh consumption at voltages beyond given voltage quality limits (i.e., ensure standard voltages at customer terminals)
- b. Minimize feeder segment(s) overload
- c. Reduce load while respecting given voltage tolerance (normal and emergency)
- d. Conserve energy via voltage reduction
- e. Reduce or eliminate overload in transmission lines
- f. Reduce or eliminate voltage violations on transmission lines
- g. Provide reactive power support for transmission/distribution bus
- h. Provide spinning reserve support
- i. Minimize cost of energy
- j. Provide compatible combinations of above objectives

If, during optimization or execution of the solution, the circuit status changes, the application is interrupted and solution is re-optimized. If, during execution, some operations are unsuccessful, solution is re-optimized without involving the malfunctioning devices. If some of the controllable devices are unavailable for remote control, solution does not involve these devices but takes into account their reaction to changes in operating conditions.

1.4.8 Pre-arming of Remedial Action Schemes (RAS)

This application receives pre-arming signals from an upper level of control and changes the settings (tuning parameters) of distribution-side remedial action schemes (RAS), e.g., load-shedding schemes (a component of self-healing grid) or intentional DER islanding.

1.4.9 Coordination of Emergency Actions

This application recognizes the emergency situation based on changes of the operating conditions or on reaction of some RAS to operational changes and coordinates the objectives, modes of operation, and constraints of other AdvancedDistributionAutomationSystem applications. For example, Under-frequency Load Shedding Schemes trigger emergency load reduction mode of volt/var control, or the under-frequency protection of DER triggers the pre-armed intentional islanding.

1.4.10 Coordination of Restorative Actions

This application coordinates the restoration of services after the emergency conditions are eliminated. For example, AdvancedDistributionAutomationSystem changes the order of feeder re-connection based on current customer priorities or inhibits return to normal voltage until there are disconnected feeders.

1.4.11 Intelligent Alarm Processing

This application analyzes SCADA and DOMA-generated alarms and other rapid changes of the operational parameters in distribution and transmission and summarizes the multiple alarms into one message defining the root cause of the alarms. For example, multiple sudden voltage violations along a distribution feeder and overloads of some feeder segments may be caused by a loss of DER excitation, or successful reclosing of a portion of feeder with loss of significant load may be caused by miss-coordination of the recloser settings and a particular fuse protecting a loaded lateral.

1.5 Actor (Stakeholder) Roles

Describe all the people (their job), systems, databases, organizations, and devices involved in or affected by the Function (e.g. operators, system administrators, technicians, end users, service personnel, executives, SCADA system, real-time database, RTO, RTU, IED, power system). Typically, these actors are logically grouped by organization or functional boundaries or just for collaboration purpose of this use case. We need to identify these groupings and their relevant roles and understand the constituency. The same actor could play different roles in different Functions, but only one role in one Function. If the same actor (e.g. the same person) does play multiple roles in one Function, list these different actor-roles as separate rows.

<i>Grouping (Community)</i>		<i>Group Description</i>
<i>Actor Name</i>	<i>Actor Type (person, device, system etc.)</i>	<i>Actor Description</i>
DisCosOperator		Person in charge of distribution operations during the shift
DistributionSC ADASystem		Distribution System Supervisory Control and Data Acquisition

<i>Grouping (Community)</i>		<i>Group Description</i>
<i>Actor Name</i>	<i>Actor Type (person, device, system etc.)</i>	<i>Actor Description</i>
ConversionValidationFunction		The C&V function uses standard interface between AM_FM_GISDatabase and converts and validates information about incremental changes implemented in the field.
ADADDataChecker		The ADADDataChecker monitors data entered into SCADA database and detects changes. When pre-defined changes are detected, the data checker triggers the ADADispatchingSystem.
ADADispatchingSystem		The ADADispatchingSystem starts corresponding AdvancedDistributionAutomationSystem functions based on pre-defined periodicity and events detected by the ADADDataChecker.
ADATopologyUpdateSystem		The ADATopologyUpdateSystem updates the AdvancedDistributionAutomationSystem topology model based on status changes detected by the data checker
ADADistributionOperationModel and Analysis (DOMA)		Calculation and Analysis of power flow/state estimation results
ADAVVCCController (VVC)		AdvancedDistributionAutomationSystem Voltage and Var Controller: Coordinated optimal control of voltage and var in distribution for different system-wide objectives
AdvancedDistributionAutomationSystem: Fault location function		Fault detection and location in distribution
AdvancedDistributionAutomationSystem: Fault Isolation and Service Restoration (FLIR)		Isolation of faulted portions of distribution feeders and restoration of services to healthy portions
AdvancedDistributionAutomationSystem		Optimal selection of feeder connectivity for different objectives

<i>Grouping (Community)</i>		<i>Group Description</i>
<i>Actor Name</i>	<i>Actor Type (person, device, system etc.)</i>	<i>Actor Description</i>
onSystem: Feeder Reconfiguration (FR)		
AdvancedDistri butionAutomati onSystem: Relay protection coordination		Adjustment of relay protection settings and operational modes of switches to provide a coordinated relay protection under real-time configuration
AdvancedDistri butionAutomati onSystem: Preaming of Remedial Action Schemes (RAS)		Change of RAS settings in anticipation of a probable emergency
ADAEmergenc yCoordinationS ystem		Change of action priorities during the emergency state of the system
ADARestoratio nCoordinationS ystem		Controlling the priorities of actions during the restorative state of the system
AdvancedDistri butionAutomati onSystem: Intelligent Alarm Processing		Summarizing multiple alarms into one descriptive message.

<i>Grouping (Community)</i>		<i>Group Description</i>
<i>Actor Name</i>	<i>Actor Type (person, device, system etc.)</i>	<i>Actor Description</i>
LoadManagementDevice		Controlling cycles of cyclic electric appliances (direct load control-DLC), interruptible and curtable loads
UFLS: Under-Frequency Load Shedding Schemes		Shedding load based on frequency conditions
UVLS: Under-Voltage Load Shedding Schemes		Shedding load based on voltage conditions
SLS: Special Load Shedding Schemes		Shedding load based on specific operating conditions
OutageManagementSystem		Trouble call processing, troubleshoot crew dispatch
WorkManagementSystem		Maintenance management in distribution
FieldPersonnel		Manual operations of field devices, repair and construction work
FieldDevice		Local intelligence for monitoring and control of automated devices in distribution, communicates with SCADA
Distributed Intelligence Schemes		Distributed Intelligence Schemes (DIS) - Performs operations in a localized distribution area based on local information and on data exchange between members of the group. Can communicate with SCADA.
IEDs of DIS members		IEDs grouped in a Distributed Intelligence Scheme
DEROwner		Maintenance and operations of DERs
TransCOs		Transmission of energy from generation to distribution within distribution-defined constraints/contracts
EnergyManage		Transmission and generation management system providing

<i>Grouping (Community)</i>		<i>Group Description</i>
<i>Actor Name</i>	<i>Actor Type (person, device, system etc.)</i>	<i>Actor Description</i>
mentSystem		AdvancedDistributionAutomationSystem with transmission/generation-related objectives, constraints, and input data
RTO/ISO		Wide-area power system control center providing high-level load management and other signals for DisCos
MarketOperationSystem		Wide-area energy market management system providing high-level market signals for DisCos
Major customers		Major users of DisCo's services according to regulatory and contract rules
CustomerServiceRepresentative		Intermediary entity between DisCos and group of customers
AM_FM_GISDatabase		Repository of distribution system assets, their relationships (connectivity), ownerships, and activities
CustomerInformationSystem		Repository of customer information related to DisCos services
AutomatedMeterReadingDevice		Automated Meter Reading interfaced with CIS and AM_FM_GISDatabases
AssetManagementSystem		Asset Management Systems interfaced with AM/FM/GIS
Remedial Action Scheme		Remedial Action Scheme performs local emergency operations based on local information, pre-armed settings and external signals. Can adapt to the changing local operating conditions.
ADADatabase		ADADatabase contains information on the current connectivity, operational parameters, electrical, economic and other relevant characteristics of the distribution power system
ADAHistoricDatabase		
ADATestDatabase		
Environmental		

<i>Grouping (Community)</i>		<i>Group Description</i>
<i>Actor Name</i>	<i>Actor Type (person, device, system etc.)</i>	<i>Actor Description</i>
daily data collector		
ITPersonnel		
LoadForecaster		
DMS SCADA Database		
Regional System Operator		
Prearming of RAS schemes function		
Fault isolation and service restoration subfunction		
AdvancedDistributionAutomationSystem load management functions		Including ADAVVCController

Replicate this table for each logic group.

1.6 Information exchanged

Describe any information exchanged in this template.

<i>Information Object Name</i>	<i>Information Object Description</i>
<i>See individual steps</i>	
AM_FM_GISDatabases	Nominal connectivity, electrical parameters, and geographic locations of distribution and transmission

<i>Information Object Name</i>	<i>Information Object Description</i>
	facilities
CIS database	Customer information including billing data, customer types, links to distribution circuits
Outage management system	Trouble call information, crew activity information.
DMS/SCADA database	Real-time data from field IEDs and output of ADAapplications
EnergyManagementSystem/SCADA	Real-time data from transmission field IEDs, output from EnergyManagementSystem applications, information support from AdvancedDistributionAutomationSystem applications
Engineering databases	Planning and design data for future facilities

What Do We Need to Know to Optimally Control Distribution?

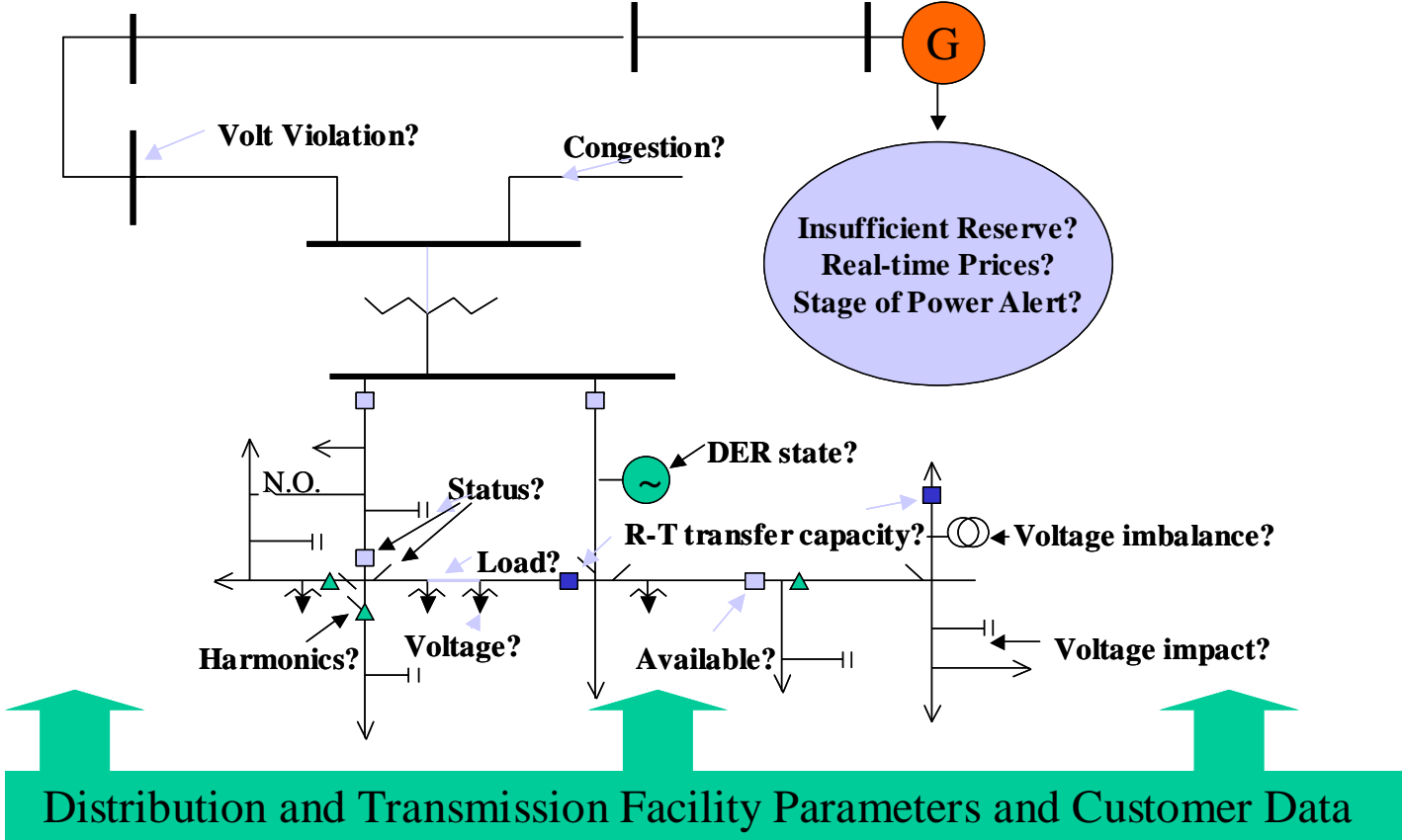

ADA INFORMATION FLOW FOR COMPUTING APPLICATIONS

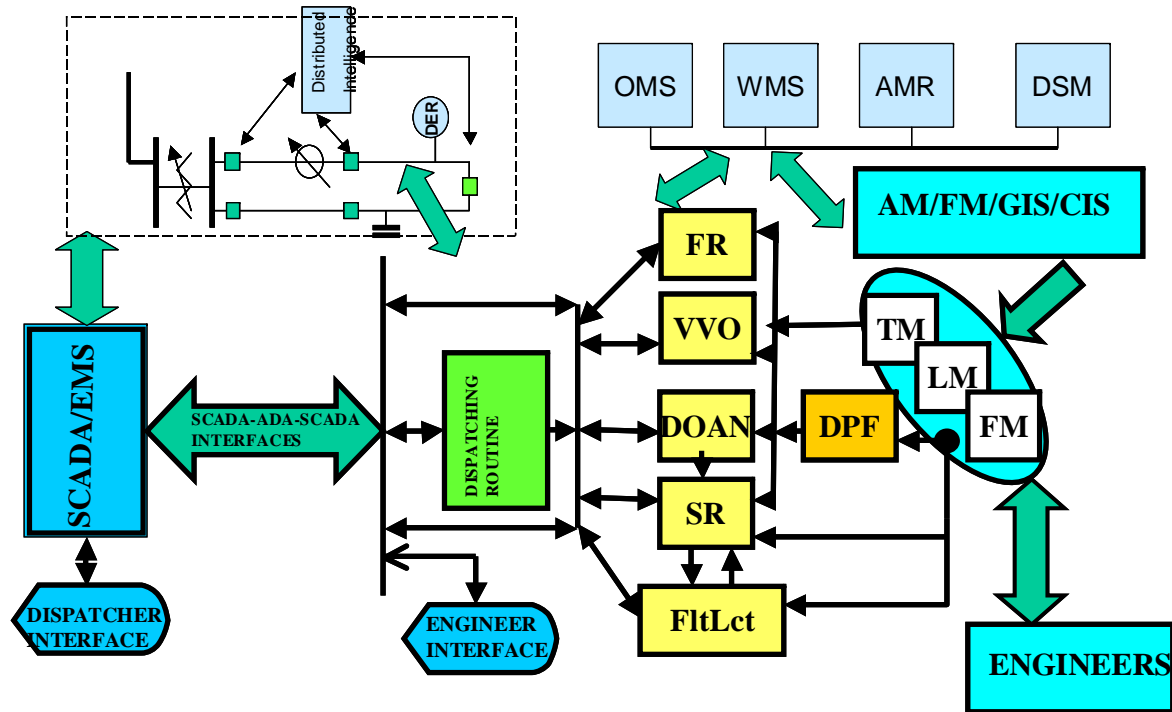

VVO - VOLT/VAR CONTROL; DOAN - DISTRIBUTION OPERATINO ANALYSIS; FltLct- FAULT LOCATION;
 SR-ISOLATION AND SERVICE RESTORATION; DPF - DISTRIBUTION POWER FLOW; TM - TOPOLOGY MODEL;
 LM - LOAD MODEL; FM - FACILITY MODELS

1.7 Activities/Services

Describe or list the activities and services involved in this Function (in the context of this Function). An activity or service can be provided by a computer system, a set of applications, or manual procedures. These activities/services should be described at an appropriate level, with the understanding that sub-activities and services should be described if they are important for operational issues, automation needs, and implementation reasons. Other sub-activities/services could be left for later analysis.

<i>Activity/Service Name</i>	<i>Activities/Services Provided</i>
<p>DOMA: AdvancedDistributionAutomationSystem updates power system model and analyzes distribution operations</p>	<ul style="list-style-type: none"> • Update of <ul style="list-style-type: none"> a) topology model b) facilities model c) load model d) relevant transmission model • Analysis of real-time operating conditions using distribution power flow/state estimation • Evaluation of system transfer capacity based on real-time measurements • Issue of alarming/warning messages to the operator • Generation of distribution operation reports and logs
<p>FLIR: AdvancedDistributionAutomationSystem performs fault location, fault isolation, and service restoration</p>	<ul style="list-style-type: none"> • AdvancedDistributionAutomationSystem indicates faults cleared by controllable protective devices by distinguishing between: <ul style="list-style-type: none"> a) faults cleared by fuses b) momentary outages c) inrush/cold load current • AdvancedDistributionAutomationSystem determines the faulted sections based on SCADA fault indications and protection lockout signals • AdvancedDistributionAutomationSystem estimates the probable fault locations based on SCADA fault current measurements and real-time fault analysis • AdvancedDistributionAutomationSystem determines the fault-clearing non-monitored protective device based on trouble call inputs and dynamic connectivity model • AdvancedDistributionAutomationSystem generates switching orders for fault isolation, service restoration, and return to normal (taking into account the availability of remotely controlled switching devices, feeder paralleling, and cold-load pickup): <ul style="list-style-type: none"> a) Regional System Operator executes switching orders by using SCADA b) Regional System Operator authorizes AdvancedDistributionAutomationSystem application to execute switching orders in closed-loop mode • AdvancedDistributionAutomationSystem isolates the fault and restores service automatically by-passing the operator based on operator's authorization in advance • AdvancedDistributionAutomationSystem pre-arms Distributed Intelligence schemes

<i>Activity/Service Name</i>	<i>Activities/Services Provided</i>
	<ul style="list-style-type: none"> AdvancedDistributionAutomationSystem considers creation of islands supported by distributed resources for service restoration
MFR: AdvancedDistributionAutomationSystem performs multi-level feeder reconfiguration for different objectives	<ul style="list-style-type: none"> > Service restoration > Overload elimination > Loss minimization > Voltage balancing > Reliability improvement
RPR: AdvancedDistributionAutomationSystem performs relay protection re-coordination	<ul style="list-style-type: none"> AdvancedDistributionAutomationSystem changes relay protection settings and modes of operation of switching devices after feeder reconfiguration AdvancedDistributionAutomationSystem changes relay protection setting in case of changed conditions for fuse saving
VVC: AdvancedDistributionAutomationSystem optimally controls volt/var by changing the states of voltage controllers, shunts, and distributed resources in a coordinated manner for different objectives under normal and emergency conditions	<ul style="list-style-type: none"> Power quality improvement Overload elimination/reduction Load management Transmission operation support in accordance with T&D contracts Loss minimization in distribution and transmission
CEA: Protection equipment performs system protection actions under emergency conditions	Based on real-time distribution system connectivity, current composition of customers, and signals from an upper level of control, AdvancedDistributionAutomationSystem provides protection system with information needed for properly performing under-frequency and under-voltage load shedding.
IAP: Intelligent alarm processing	Alarms, measurements, and messages produced by SCADA and AdvancedDistributionAutomationSystem are processed by IAP to determine the root cause of the problem and deliver the summary message to the appropriate recipients of this information.
SCADA: system performs disturbance monitoring	<ul style="list-style-type: none"> Fault current recording Fault location Event recording Disturbance analysis
Op Dispatch: Operators dispatch field crews to troubleshoot power system and customer power problems	Operators perform emergency switching operations to rapidly restore normal operating conditions by dispatching crews using <ul style="list-style-type: none"> Mobile radio system Mobile computing
LMS: Operators performs intrusive load	<ul style="list-style-type: none"> Operators or planners identify critical loads (hospitals, etc.) in advance

<i>Activity/Service Name</i>	<i>Activities/Services Provided</i>
management activities	<ul style="list-style-type: none"> • ADA system locks out load shedding of critical loads • Operators activate direct load control, prioritized by AdvancedDistributionAutomationSystem • Operators activate load curtailment, prioritized by AdvancedDistributionAutomationSystem • Operators apply load interruption, prioritized by AdvancedDistributionAutomationSystem • Operators enable emergency load reduction via AdvancedDistributionAutomationSystem volt/var control • Operators apply manual rolling blackouts
Operators enable emergency (major event) mode of operations for maintenance personnel and major event emergency mode of operation of AdvancedDistributionAutomationSystem	Prepare personnel and automated system for actions under severe emergency conditions.
Outage management systems collect trouble calls, generate outage information, arrange work for troubleshooting	Expedite fault location based on customer call-in information by using dynamic connectivity models
Interactive utility-customer systems inform the customers about the progress of events	<ul style="list-style-type: none"> • Timely customers update about the progress of service restoration • Automated messaging based on service restoration progress and association of customers' communication nodes with the faulted area
AdvancedDistributionAutomationSystem performs in major event emergency mode	<ul style="list-style-type: none"> • Automated data preparation, optimal decision making, and control of distribution operations in a coordinated with other systems manner under conditions of major events with more challenging safety and timing requirements • Pre-arming of automatic/automated systems for operations under major event conditions and fast acting fault location, isolation, service restoration, feeder reconfiguration, volt/var control, and operation analysis

1.8 Contracts/Regulations

Identify any overall (human-initiated) contracts, regulations, policies, financial considerations, engineering constraints, pollution constraints, and other environmental quality issues that affect the design and requirements of the Function.

<i>Contract/Regulation</i>	<i>Impact of Contract/Regulation on Function</i>
Contract between DISCO and TRANSCO	<p>Operational boundaries. If the boundaries are at the circuit breaker level, then AdvancedDistributionAutomationSystem has no direct access to substation capacitors and voltage regulators within the substation fence. In order to execute coordinated Volt/Var control, feeder reconfiguration, service restoration, AdvancedDistributionAutomationSystem needs information about the substation connectivity, substation transformer loading, state of voltage regulators and capacitors, and their controllers. Furthermore,</p>

<i>Contract/Regulation</i>	<i>Impact of Contract/Regulation on Function</i>
	<p>AdvancedDistributionAutomationSystem should have capabilities for controlling these devices in a closed-loop mode. If the boundaries are at the high-voltage side of the substation transformer, then AdvancedDistributionAutomationSystem has access to the substation devices and corresponding information.</p> <p>Volt/Var Agreement. Defines the voltage limits at the transmission side and reactive power requirements for distribution side. If the contractual parameters are not respected, the Volt/Var application may not meet its objectives, and the voltage limits at the customer side may be violated.</p>
Contracts between DISCO and DEROwner	<p>Schedules. Defines amount of kW generated by DER at different times and constraints for power flow at PCC. Deviation from schedules must be timely detected and compensated by other reserve capabilities of the distribution system.</p> <p>Volt/Var control agreement. Defines modes of DER operation and setting for Volt/Var control. Defines rules for changes of modes of operation and setting (local/remote, DER/EPS). Deviation from agreement must be timely detected and compensated by other reserve capabilities of the distribution system.</p> <p>Standard 1547. Defines rules for interconnection between DER and DISCO (EPS). Deviation from the rules may result in violation of power quality limits, delays in service restoration, damage of DER equipment. Deviation from the standard must be timely detected and remedial actions must be implemented.</p>
Contracts between Disco and Customers	<p>Standard 519. Defines power quality requirements at customer terminals. AdvancedDistributionAutomationSystem functions are designed to respect these requirements. AdvancedDistributionAutomationSystem must be capable of monitoring or accurately estimating the power quality parameters at the customer terminals, report and eliminate (or significantly reduce) the violations.</p> <p>Performance based rates. Defines the target level of service reliability. The distribution system and the AdvancedDistributionAutomationSystem function should be design to meet the target.</p> <p>Reliability guarantees. AdvancedDistributionAutomationSystem function should distinguish the customers with reliability guarantees from those without and focus the service restoration solution on meeting the guarantees, while providing other customers with target service reliability.</p> <p>Load management agreements. Defines the conditions, amount, and frequency of direct load control, load curtailment, interruption, and shedding.</p>

<i>Policy</i>	<i>From Actor</i>	<i>May</i>	<i>Shall Not</i>	<i>Shall</i>	<i>Description (verb)</i>	<i>To Actor</i>

<i>Constraint</i>	<i>Type</i>	<i>Description</i>	<i>Applies to</i>

2 Step by Step Analysis of Function

Describe steps that implement the function. If there is more than one set of steps that are relevant, make a copy of the following section grouping (Preconditions and Assumptions, Steps normal sequence, and Steps alternate or exceptional sequence, Post conditions)

2.1 Distribution Operation Modeling and Analysis (DOMA) Function

Name of this sequence.

2.1.1 DOMA Preconditions and Assumptions

Describe conditions that must exist prior to the initiation of the Function, such as prior state of the actors and activities

Identify any assumptions, such as what systems already exist, what contractual relations exist, and what configurations of systems are probably in place

Identify any initial states of information exchanged in the steps in the next section. For example, if a purchase order is exchanged in an activity, its precondition to the activity might be 'filled in but unapproved'.

<i>Actor/System/Information/Contract</i>	<i>Preconditions or Assumptions</i>
AM_FM_GISDatabase	AM/FM database contains the geographical information of the distribution power system circuit connectivity, as well as the parameters describing the power system facilities. Conceptually, the AM_FM_GISDatabase can contain transmission connectivity and facility data and relevant to distribution operations customer-related data.
CIS system (or proxy for CIS data)	CIS contains load data for customers that is estimated for each nodal location on a feeder, based on billing data and time-of-day and day-of week load shapes for different load categories.
EnergyManagementSystem SCADA	EnergyManagementSystem system contains the transmission power system model, and can provide the transmission connectivity information for facilities in the vicinity of the distribution power system facilities and with outputs from other EnergyManagementSystem applications
DMS SCADA database	DistributionSCADASystem database is updated via remote monitoring and operator inputs.. Required scope, speed, and accuracy of real-time measurements are provided, supervisory and closed-loop control is supported.
ConversionValidationFunction	The C&V function extracts incremental changes from AM/FM/GIS/CustomerInformationSystem and converts it into AdvancedDistributionAutomationSystem database format
Environmental daily data collector	Collects environmental data
Regional System Operator	One who makes decisions on operation of the power system
LoadForecaster	Load forecasting system
ADADDataChecker	ADADDataChecker frequently checks the changes in SCADA database
ADADispatchingSystem	ADADispatchingSystem is designed to coordinate the AdvancedDistributionAutomationSystem functions in a pre-defined manner

<i>Actor/System/Information/Contract</i>	<i>Preconditions or Assumptions</i>
ADATopologyUpdateSystem	Checks the topology of the distribution system
ITPersonnel	Field IT support
ADATopologyUpdateSystem	ADATopologyUpdateSystem “reconfigures” connectivity models in seconds
ADATestDatabase	Database containing test data values
ADADistributionOperationModeling and Analysis (DOMA)	Preconditions: DistributionSCADASystem with several IEDs along distribution feeders, reporting statuses of remotely controlled switches and analogs including Amps, kW, kvar, and kV. Regional System Operator’s ability for updating the SCADA database with statuses of switches not monitored remotely. Substation SCADA with analogs and statuses from CBs exists. EnergyManagementSystem is interfaced with AdvancedDistributionAutomationSystem. AdvancedDistributionAutomationSystem database is updated with the latest AM/FM and CIS data and operators input. The options for DOMA performance are selected

2.1.2 DOMA Steps – Normal Sequence

Describe the normal sequence of events, focusing on steps that identify new types of information or new information exchanges or new interface issues to address. Should the sequence require detailed steps that are also used by other functions, consider creating a new “sub” function, then referring to that “subroutine” in this function. Remember that the focus should be less on the algorithms of the applications and more on the interactions and information flows between “entities”, e.g. people, systems, applications, data bases, etc. There should be a direct link between the narrative and these steps.

The numbering of the sequence steps conveys the order and concurrency and iteration of the steps occur. Using a Dewey Decimal scheme, each level of nested procedure call is separated by a dot ‘.’. Within a level, the sequence number comprises an optional letter and an integer number. The letter specifies a concurrent sequence within the next higher level; all letter sequences are concurrent with other letter sequences. The number specifies the sequencing of messages in a given letter sequence. The absence of a letter is treated as a default ‘main sequence’ in parallel with the lettered sequences.

Sequence 1:

```

1.1 - Do step 1
1.2A.1 - In parallel to activity 2 B do step 1
1.2A.2 - In parallel to activity 2 B do step 2
1.2B.1 - In parallel to activity 2 A do step 1
1.2B.2 - In parallel to activity 2 A do step 2
1.3 - Do step 3
1.3.1 - nested step 3.1
1.3.2 - nested step 3.2

```

Sequence 2:

- 2.1 - Do step 1
- 2.2 - Do step 2

2.1.2.1 Data Conversion and Validation

#	Event	Primary Actor	Name of Process/Activity	Description of Process/Activity	Information Producer	Information Receiver	Name of Info Exchanged	Additional Notes	IECSA Environments
#	<i>Triggering event: Identify the name of the event.²</i>	<i>What other actors are primarily responsible for the Process/Activity. Actors are defined in section 1.5.</i>	<i>Label that would appear in a process diagram. Use action verbs when naming activity.</i>	<i>Describe the actions that take place in active and present tense. The step should be a descriptive noun/verb phrase that portrays an outline summary of the step. "If ...Then...Else" scenarios can be captured as multiple Actions or as separate steps.</i>	<i>What other actors are primarily responsible for Producing the information. Actors are defined in section 1.5.</i>	<i>What other actors are primarily responsible for Receiving the information. Actors are defined in section 1.5. (Note – May leave blank if same as Primary Actor)</i>	<i>Name of the information object. Information objects are defined in section 1.6</i>	<i>Elaborate architectural issues using attached spreadsheet. Use this column to elaborate details that aren't captured in the spreadsheet.</i>	<i>Reference the applicable IECSA Environment containing this data exchange. Only one environment per step.</i>
1.1.1	Data conversion and validation	ADADatabase Administrator, ConversionValidationFunction	Extraction, conversion & validation	ADADatabase Administrator authorizes the Conversion and Validation function to extract, convert and validate circuit connectivity and distribution transformer loading data. This is referred to as Stage 1 validation.	ADADatabase Administrator	ConversionValidationFunction	Authorization to start Stage 1 validation		Intra-Control Center

² Note – A triggering event is not necessary if the completion of the prior step leads to the transition of the following step.

#	Event	Primary Actor	Name of Process/Activity	Description of Process/Activity	Information Producer	Information Receiver	Name of Info Exchanged	Additional Notes	IECSA Environments
1.1.2		DMS SCADA database, DOMA function	Checking real-time data	The data in the latest download of DMS SCADA data is checked by DOMA function for changes in topology and used to obtain the latest relevant analog data.	DMS SCADA database	DOMA function	DMS real-time analog, status & TLQ data		Intra-Control Center
1.1.3		DOMA function, ADATopologyUpdateSystem	Connectivity change	ADATopologyUpdateSystem prepares changes in connectivity based on the latest DMS SCADA data for updating AdvancedDistributionAutomationSystem database	DOMA function	ADATopologyUpdateSystem	Changes in connectivity		Intra-Control Center
1.1.4		ADATopologyUpdateSystem, ADADatabase	Advanced DistributionAutomationSystem database update	ADATopologyUpdateSystem updates AdvancedDistributionAutomationSystem database	ADATopologyUpdateSystem	ADADatabase	AdvancedDistributionAutomationSystem database update		Intra-Control Center
1.1.5		AM/FM/GIS Database, ConversionValidationFunction	Extraction, conversion & validation	Conversion and Validation function receives initial (before any corrections) connectivity, billing and facility parameter data.	AM_FM_GIS Database	ConversionValidationFunction	Initial connectivity, billing and facility parameter data		Intra-Control Center

#	Event	Primary Actor	Name of Process/Activity	Description of Process/Activity	Information Producer	Information Receiver	Name of Info Exchanged	Additional Notes	IECSA Environments
1.1.6		ConversionValidationFunction, ADADatabase Administrator	Issuing initial Stage 1 report	After Conversion and Validation function completes Stage 1 analysis it issues a report with incorrect circuit connectivity and transformer loading	ConversionValidationFunction	ADADatabase Administrator	Report with incorrect circuit connectivity and transformer loading		Intra-Control Center
1.1.7		ADADatabase Administrator	Stage 1 corrections	After reviewing the Stage 1 report, the ADADatabase Administrator issues an authorization to perform Stage 1 corrections.	ADADatabase Administrator	ITPersonnel	Authorization to perform Stage 1 corrections		User Interface
1.1.8		ITPersonnel	Stage 1 corrections	AM_FM_GISDatabase is corrected based on the Stage 1 report after ADADatabase Administrator authorized the procedure.	ITPersonnel	AM_FM_GIS Database	Stage 1 corrections		User Interface
1.1.9		AM_FM_GISDatabase, ConversionValidationFunction	Extraction, conversion & validation	Conversion and Validation function receives connectivity, billing and facility parameter data after Stage 1 corrections have been implemented.	AM_FM_GIS Database	ConversionValidationFunction	Connectivity, billing and facility parameter data after Stage 1		Intra-Control Center

#	Event	Primary Actor	Name of Process/Activity	Description of Process/Activity	Information Producer	Information Receiver	Name of Info Exchanged	Additional Notes	IECSA Environments
1.1.10		ConversionValidationFunction, ADADatabase Administrator	Issuing report requiring no database corrections after Stage 1	After Conversion and Validation function completes Stage 1 analysis it issues a report showing that no further corrections associated with connectivity, billing or facility parameter data are required.	ConversionValidationFunction	ADADatabase Administrator	Report showing that circuit connectivity and transformer loading require no corrections		User Interface
1.1.11		ConversionValidationFunction, ADATestDatabase	Update of Advanced DistributionAutomationSystem Test Database after Stage 1 corrections	After Stage 1 corrections produce a report with no connectivity and transformer loading problems, the Conversion and Validation function updates the AdvancedDistributionAutomationSystem Test Database which sets the stage for Stage 2 validation.	ConversionValidationFunction	ADATestDatabase	Update of AdvancedDistributionAutomationSystem Test Database		Intra-Control Center

#	Event	Primary Actor	Name of Process/Activity	Description of Process/Activity	Information Producer	Information Receiver	Name of Info Exchanged	Additional Notes	IECSA Environments
1.1.12		ADADatabase Administrator, ConversionValidationFunction	Load Flow and Load Transfer Analyses	ADADatabase Administrator authorizes the Conversion and Validation function to validate facility parameters via load flow and load transfer analyses. This is referred to as Stage 2 validation.	ADADatabase Administrator	ConversionValidationFunction	Authorization to start Stage 2 validation		Intra-Control Center
1.1.13		ConversionValidationFunction, ADATestDatabase	Load Flow and Load Transfer Analyses	Conversion and Validation function receives excerpts from AdvancedDistributionAutomationSystem Test Database (after they were updated with Stage 1 corrections) to perform Stage 2 analyses.	ADATestDatabase	ConversionValidationFunction	Excerpts from AdvancedDistributionAutomationSystem Test Database after Stage 1 corrections		Intra-Control Center

#	Event	Primary Actor	Name of Process/Activity	Description of Process/Activity	Information Producer	Information Receiver	Name of Info Exchanged	Additional Notes	IECSA Environments
1.1.14		ConversionValidationFunction, ADADatabase	Load Flow and Load Transfer Analyses	Conversion and Validation function receives latest statuses and measurements from ADADatabase (which in turn are updated by DMS SCADADatabase) to perform Stage 2 analyses.	ADADatabase	ConversionValidationFunction	Latest statuses and measurements from ADADatabase		Intra-Control Center
1.1.15		ConversionValidationFunction, ADADatabase Administrator	Load Flow and Load Transfer Analyses	After performing Stage 2 analyses, Conversion and Validation function issues a report for ADADatabase Administrator.	ConversionValidationFunction	ADADatabase Administrator	Report on unreasonable load and voltage violations, corresponding facility parameters, results of comparative analyses and correction of inconsistencies		User Interface
1.1.16		ADADatabase Administrator	Stage 2 corrections	After reviewing the Stage 2 report, the ADADatabase Administrator issues an authorization to perform Stage 2 corrections.	ADADatabase Administrator	ITPersonnel	Authorization to perform Stage 2 corrections		User Interface

#	Event	Primary Actor	Name of Process/Activity	Description of Process/Activity	Information Producer	Information Receiver	Name of Info Exchanged	Additional Notes	IECSA Environments
1.1.17		ADADatabase Administrator, AM/FM/GIS Database	Stage 2 corrections	AM_FM_GISDatabase is corrected based on the Stage 2 report after ADADatabase Administrator authorized the procedure.	ITPersonnel	AM_FM_GIS Database	Stage 2 corrections		User Interface
1.1.18		AM/FM/GIS Database, ConversionValidationFunction	Extraction, conversion & validation	Conversion and Validation function receives connectivity, billing and facility parameter data after Stage 2 corrections have been implemented.	AM_FM_GIS Database	ConversionValidationFunction	Connectivity, billing and facility parameter data after Stage 2		Intra-Control Center
1.1.19		ConversionValidationFunction, ADATestDatabase	Update of Advanced DistributionAutomationSystem Test Database after Stage 2 corrections	The Conversion and Validation function updates the AdvancedDistributionAutomationSystem Test Database.	ConversionValidationFunction	ADATestDatabase	Update of AdvancedDistributionAutomationSystem Test Database		Intra-Control Center

#	Event	Primary Actor	Name of Process/Activity	Description of Process/Activity	Information Producer	Information Receiver	Name of Info Exchanged	Additional Notes	IECSA Environments
1.1.20		ConversionValidationFunction, ADATestDatabase	Load Flow and Load Transfer Analyses	Conversion and Validation function receives excerpts from AdvancedDistributionAutomationSystem Test Database (after they were updated with Stage 2 corrections) to perform the next round of Stage 2 analyses.	ADATestDatabase	ConversionValidationFunction	Excerpts from AdvancedDistributionAutomationSystem Test Database after Stage 2 corrections		Intra-Control Center
1.1.21		ConversionValidationFunction, ADADatabase	Load Flow and Load Transfer Analyses	Conversion and Validation function receives latest statuses and measurements from ADADatabase (which in turn are updated by DMS SCADADatabase) to perform the next round of Stage 2 analyses.	ADADatabase	ConversionValidationFunction	Latest statuses and measurements from ADADatabase		Intra-Control Center

#	Event	Primary Actor	Name of Process/Activity	Description of Process/Activity	Information Producer	Information Receiver	Name of Info Exchanged	Additional Notes	IECSA Environments
1.1.22		ConversionValidationFunction, ADADatabase Administrator	Issuing report requiring no database corrections after Stage 2	After Conversion and Validation function completes Stage 2 analysis it issues a report showing that no further corrections associated with unreasonable load and voltage violations, or corresponding facility parameters are required.	ConversionValidationFunction	ADADatabase Administrator	Report showing that no further corrections associated with unreasonable load and voltage violations, or corresponding facility parameters are required.		User Interface
1.1.23		ADADatabase Administrator	Update of ADADatabase	After reviewing the Stage 2 report requiring no further corrections, ADADatabase Administrator authorizes the update of AdvancedDistributionAutomationSystem database.	ADADatabase Administrator	ITPersonnel	Authorization to update AdvancedDistributionAutomationSystem database		User Interface

#	Event	Primary Actor	Name of Process/Activity	Description of Process/Activity	Information Producer	Information Receiver	Name of Info Exchanged	Additional Notes	IECSA Environments
1.1.24		IT Personnel, ADATestDatabase	Update of ADADatabase	After permission to update AdvancedDistributionAutomationSystem database is given, IT Personnel receives the needed update from AdvancedDistributionAutomationSystem Test database.	ADATestDatabase	IT Personnel	AdvancedDistributionAutomationSystem database update		User Interface
1.1.25		IT Personnel, ADADatabase	Update of ADADatabase	IT Personnel updates AdvancedDistributionAutomationSystem database	IT Personnel	ADADatabase	AdvancedDistributionAutomationSystem database update		User Interface

2.1.2.2 DOMA No Events

#	Event	Primary Actor	Name of Process/Activity	Description of Process/Activity	Information Producer	Information Receiver	Name of Info Exchanged	Additional Notes	IECSA Environments
#	<i>Triggering event: Identify the name of the event.³</i>	<i>What other actors are primarily responsible for the Process/Activity. Actors are defined in section 1.5.</i>	<i>Label that would appear in a process diagram. Use action verbs when naming activity.</i>	<i>Describe the actions that take place in active and present tense. The step should be a descriptive noun/verb phrase that portrays an outline summary of the step. "If ...Then...Else" scenarios can be captured as multiple Actions or as separate steps.</i>	<i>What other actors are primarily responsible for Producing the information. Actors are defined in section 1.5.</i>	<i>What other actors are primarily responsible for Receiving the information. Actors are defined in section 1.5. (Note – May leave blank if same as Primary Actor)</i>	<i>Name of the information object. Information objects are defined in section 1.6</i>	<i>Elaborate architectural issues using attached spreadsheet. Use this column to elaborate details that aren't captured in the spreadsheet.</i>	<i>Reference the applicable IECSA Environment containing this data exchange. Only one environment per step.</i>

³ Note – A triggering event is not necessary if the completion of the prior step leads to the transition of the following step.

1.2.1	DOMA No Events	DMS SCADA database, DOMA function	Checking real-time data	DOMA function receives the latest scan of DMS SCADA database to be checked for relevant changes or events.	DMS SCADA database	DOMA function	DMS real-time analog, status, TLQ data		Intra-Control Center
1.2.2		EnergyManagementSystem SCADA database, DOMA function	Checking real-time data	DOMA function receives the latest scan of EnergyManagementSystem SCADA database to be checked for relevant changes or events.	EnergyManagementSystem SCADA database	DOMA function	EnergyManagementSystem real-time analog, status, TLQ data		Intra-Control Center
1.2.3		DOMA function	Checking real-time data	DOMA determines that no changes or events are present in SCADA scan.	DOMA function	DOMA function	No changes or events are detected.		Intra-Control Center
1.2.4		DOMA function	DOMA function status verification	DOMA status is verified (on/off) for reporting it to the Regional System Operator.	DOMA function	Regional System Operator	DOMA function status		User Interface

2.1.2.3 DOMA Event Run

#	Event	Primary Actor	Name of Process/Activity	Description of Process/Activity	Information Producer	Information Receiver	Name of Info Exchanged	Additional Notes	IECSA Environments
#	<i>Triggering event: Identify the name of the event.⁴</i>	<i>What other actors are primarily responsible for the Process/Activity. Actors are defined in section 1.5.</i>	<i>Label that would appear in a process diagram. Use action verbs when naming activity.</i>	<i>Describe the actions that take place in active and present tense. The step should be a descriptive noun/verb phrase that portrays an outline summary of the step. "If ...Then...Else" scenarios can be captured as multiple Actions or as separate steps.</i>	<i>What other actors are primarily responsible for Producing the information. Actors are defined in section 1.5.</i>	<i>What other actors are primarily responsible for Receiving the information. Actors are defined in section 1.5. (Note – May leave blank if same as Primary Actor)</i>	<i>Name of the information object. Information objects are defined in section 1.6</i>	<i>Elaborate architectural issues using attached spreadsheet. Use this column to elaborate details that aren't captured in the spreadsheet.</i>	<i>Reference the applicable IECSA Environment containing this data exchange. Only one environment per step.</i>
1.3.1	DOMA Event Run	DMS SCADA database, DOMA function	Checking real-time data	DOMA function receives the latest scan of DMS SCADA database to be checked for relevant changes or events.	DMS SCADA database	DOMA function	DMS real-time analog, status, TLQ data		Intra-Control Center
1.3.2		EnergyManagementSystem SCADA database, DOMA function	Checking real-time data	DOMA function receives the latest scan of EnergyManagementSystem SCADA database to be checked for relevant changes or events.	EnergyManagementSystem SCADA database	DOMA function	EnergyManagementSystem real-time analog, status, TLQ data		Intra-Control Center

⁴ Note – A triggering event is not necessary if the completion of the prior step leads to the transition of the following step.

#	Event	Primary Actor	Name of Process/Activity	Description of Process/Activity	Information Producer	Information Receiver	Name of Info Exchanged	Additional Notes	IECSA Environments
1.3.3		DOMA function	Checking real-time data	DOMA, after detecting changes in connectivity, transfers relevant data to ADATopologyUpdateSystem.	DOMA function	ADATopologyUpdateSystem	Changes in connectivity		Intra-Control Center
1.3.4		ADATopologyUpdateSystem, ADADatabase	Advanced DistributionAutomationSystem database update	ADATopologyUpdateSystem updates AdvancedDistributionAutomationSystem database with detected changes in connectivity detected by DOMA function and with latest analog measurements.	ADATopologyUpdateSystem	ADADatabase	Changes in connectivity and latest analog measurements		Intra-Control Center
1.3.5		ADATopologyUpdateSystem, DOMA function	Checking distribution model integrity	ADATopologyUpdateSystem gives permission to DOMA function to analyze the distribution model integrity after AdvancedDistributionAutomationSystem database is updated with latest changes.	ADATopologyUpdateSystem	DOMA function	Permission to analyze distribution model integrity		Intra-Control Center

#	Event	Primary Actor	Name of Process/Activity	Description of Process/Activity	Information Producer	Information Receiver	Name of Info Exchanged	Additional Notes	IECSA Environments
1.3.6		ADADatabase, DOMA function	Checking distribution model integrity	DOMA function receives the data from AdvancedDistributionAutomationSystem database needed for integrity check.	ADADatabase	DOMA function	Excerpts from AdvancedDistributionAutomationSystem database		Intra-Control Center
1.3.7a		DOMA function	Checking distribution model integrity	The distribution model integrity is confirmed and DOMA gives the permission for performing state estimation and power flow calculations.	DOMA function	DOMA function	Permission for performing state estimation and power flow calculations		Intra-Control Center
1.3.8a		ADADatabase, DOMA function	State estimation and power flow calculations	DOMA function receives the data from AdvancedDistributionAutomationSystem database needed for state estimation and power flow calculations.	ADADatabase	DOMA function	Excerpts from AdvancedDistributionAutomationSystem database		Intra-Control Center

#	Event	Primary Actor	Name of Process/Activity	Description of Process/Activity	Information Producer	Information Receiver	Name of Info Exchanged	Additional Notes	IECSA Environments
1.3.9a		DOMA function, FLIR function	State estimation and power flow calculations	Upon completion of state estimation and power flow calculations, DOMA function makes the connectivity, facility (including controllers), load and transmission data available to FLIR function.	DOMA function	FLIR function	Connectivity, facility (including controllers), load and transmission data		Intra-Control Center
1.3.10a		DOMA function, ADAVVCController	State estimation and power flow calculations	Upon completion of state estimation and power flow calculations, DOMA function makes the connectivity, facility (including controllers), load and transmission data available to ADAVVCController.	DOMA function	ADAVVCController	Connectivity, facility (including controllers), load and transmission data		Intra-Control Center
1.3.11a		DOMA function	Analysis of distribution state estimation and power flow results	DOMA makes results of power flow calculations available for analysis.	DOMA function	DOMA function	Results of power flow calculations		Intra-Control Center

#	Event	Primary Actor	Name of Process/Activity	Description of Process/Activity	Information Producer	Information Receiver	Name of Info Exchanged	Additional Notes	IECSA Environments
1.3.12a		DOMA function, ADAHistoricDatabase	Analysis of distribution state estimation and power flow results	DOMA issues a report with results of analysis of state estimation and power flow calculations for storage in historic AdvancedDistributionAutomationSystem database.	DOMA function	ADAHistoric Database	Power flow results, dispatchable kW & kvar, bus voltage limits, customer extreme voltages, segment and xmfr overloads, imbalances, load transfer capacity for selected ties, losses, quality and fault analyses, alarms (if any) about load/voltage violations and from fault analysis, logs		Intra-Control Center

#	Event	Primary Actor	Name of Process/Activity	Description of Process/Activity	Information Producer	Information Receiver	Name of Info Exchanged	Additional Notes	IECSA Environments
1.3.13a		DOMA function, Regional System Operator	Analysis of distribution state estimation and power flow results	Selected results of analysis of state estimation and power flow calculations are made available for the Regional System Operator, EnergyManagementSystem, and distributed intelligence schemes.	DOMA function	Regional System Operator, EnergyManagementSystem	DOMA function status, dispatchable kW & kvar, bus voltage limits, aggregated load characteristics, transfer capacity, customer extreme voltages and imbalances, alarms (if any) about load/voltage violations and from fault analysis		Intra-Control Center
1.3.14a		DOMA function, ADAVVCController	Analysis of distribution state estimation and power flow results	If analysis of state estimation and power flow calculations detect a voltage or overload violation, VVC is initiated	DOMA function	ADAVVCController	Initiation of VVC		Intra-Control Center

#	Event	Primary Actor	Name of Process/Activity	Description of Process/Activity	Information Producer	Information Receiver	Name of Info Exchanged	Additional Notes	IECSA Environments
1.3.7b		DOMA function, ADADatabase	Checking distribution model integrity	If checking the distribution model integrity identifies a model inconsistency, a message describing the inconsistency is issued for storage in AdvancedDistributionAutomationSystem database.	DOMA function	ADADatabase	Message describing distribution model inconsistency		Intra-Control Center
1.3.8b		DOMA function, Regional System Operator	Checking distribution model integrity	If checking the distribution model integrity identifies a model inconsistency, a message describing the inconsistency is issued for the Regional System Operator.	DOMA function	Regional System Operator	Message describing distribution model inconsistency		User Interface
1.3.9b		DOMA function, ADAVVCController	Checking distribution model integrity	If checking the distribution model integrity identifies a model inconsistency, a command to switch VVC to default settings is issued.	DOMA function	ADAVVCController	Command to switch ADAVVCController to default settings		Intra-Control Center

#	Event	Primary Actor	Name of Process/Activity	Description of Process/Activity	Information Producer	Information Receiver	Name of Info Exchanged	Additional Notes	IECSA Environments
1.3.10b		DOMA function, FLIR function	Checking distribution model integrity	If checking the distribution model integrity identifies a model inconsistency, a command to switch FLIR to default settings is issued.	DOMA function	FLIR	Command to switch FLIR to default settings		Intra-Control Center

2.1.2.4 DOMA Scheduled Run

#	Event	Primary Actor	Name of Process/Activity	Description of Process/Activity	Information Producer	Information Receiver	Name of Info Exchanged	Additional Notes	IECSA Environments
#	<i>Triggering event: Identify the name of the event.⁵</i>	<i>What other actors are primarily responsible for the Process/Activity. Actors are defined in section 1.5.</i>	<i>Label that would appear in a process diagram. Use action verbs when naming activity.</i>	<i>Describe the actions that take place in active and present tense. The step should be a descriptive noun/verb phrase that portrays an outline summary of the step. "If ...Then...Else" scenarios can be captured as multiple Actions or as separate steps.</i>	<i>What other actors are primarily responsible for Producing the information. Actors are defined in section 1.5.</i>	<i>What other actors are primarily responsible for Receiving the information. Actors are defined in section 1.5. (Note – May leave blank if same as Primary Actor)</i>	<i>Name of the information object. Information objects are defined in section 1.6</i>	<i>Elaborate architectural issues using attached spreadsheet. Use this column to elaborate details that aren't captured in the spreadsheet.</i>	<i>Reference the applicable IECSA Environment containing this data exchange. Only one environment per step.</i>
1.4.1	DOMA Scheduled Run	DMS SCADA database, DOMA function	Checking real-time data	DOMA function receives the latest scan of DMS SCADA database to be checked for relevant changes or events.	DMS SCADA database	DOMA function	DMS real-time analog, status, TLQ data		Intra-Control Center

⁵ Note – A triggering event is not necessary if the completion of the prior step leads to the transition of the following step.

#	Event	Primary Actor	Name of Process/Activity	Description of Process/Activity	Information Producer	Information Receiver	Name of Info Exchanged	Additional Notes	IECSA Environments
1.4.2		EnergyManagementSystem SCADA database, DOMA function	Checking real-time data	DOMA function receives the latest scan of EnergyManagementSystem SCADA database to be checked for relevant changes or events.	EnergyManagementSystem SCADA database	DOMA function	EnergyManagementSystem real-time analog, status, TLQ data		Intra-Control Center
1.4.3		DOMA function	Checking real-time data	DOMA determines that no changes or events are present in SCADA scan.	DOMA function	DOMA function	No changes or events are detected.		Intra-Control Center
1.4.4		ADADatabase, DOMA function	State estimation and power flow calculations	DOMA function receives the data from AdvancedDistributionAutomationSystem database needed for state estimation and power flow calculations.	ADADatabase	DOMA function	Excerpts from AdvancedDistributionAutomationSystem database		Intra-Control Center
1.4.5		DOMA function, FLIR function	State estimation and power flow calculations	Upon completion of state estimation and power flow calculations, DOMA function makes the connectivity, facility (including controllers), load and transmission data available to FLIR function.	DOMA function	FLIR function	Connectivity, facility (including controllers), load and transmission data		Intra-Control Center

#	Event	Primary Actor	Name of Process/Activity	Description of Process/Activity	Information Producer	Information Receiver	Name of Info Exchanged	Additional Notes	IECSA Environments
1.4.6		DOMA function, ADAVVCController	State estimation and power flow calculations	Upon completion of state estimation and power flow calculations, DOMA function makes the connectivity, facility (including controllers), load and transmission data available to ADAVVCController.	DOMA function	ADAVVCController	Connectivity, facility (including controllers), load and transmission data		Intra-Control Center
1.4.7		DOMA function	Analysis of distribution state estimation and power flow results	DOMA makes results of power flow calculations available for analysis.	DOMA function	DOMA function	Results of power flow calculations		Intra-Control Center

#	Event	Primary Actor	Name of Process/Activity	Description of Process/Activity	Information Producer	Information Receiver	Name of Info Exchanged	Additional Notes	IECSA Environments
1.4.8		DOMA function, ADAHistoricDatabase	Analysis of distribution state estimation and power flow results	DOMA issues a report with results of analysis of state estimation and power flow calculations for storage in historic AdvancedDistributionAutomationSystem database.	DOMA function	ADAHistoric Database	Power flow results, dispatchable kW & kvar, bus voltage limits, customer extreme voltages, segment and xmfr overloads, imbalances, load transfer capacity for selected ties, losses, quality and fault analyses, alarms (if any) about load/voltage violations and from fault analysis, logs		Intra-Control Center

#	Event	Primary Actor	Name of Process/Activity	Description of Process/Activity	Information Producer	Information Receiver	Name of Info Exchanged	Additional Notes	IECSA Environments
1.4.9		DOMA function, Regional System Operator	Analysis of distribution state estimation and power flow results	Selected results of analysis of power flow calculations are made available for the Regional System Operator and EnergyManagementSystem.	DOMA function	Regional System Operator, EnergyManagementSystem	DOMA function status, dispatchable kW & kvar, bus voltage limits, customer extreme voltages and imbalances, alarms (if any) about load/voltage violations and from fault analysis		Intra-Control Center
1.4.10		DOMA function, distributed intelligence schemes	Analysis of distribution state estimation and power flow results	Analysis of power flow results includes transfer capacity of selected ties, which is transmitted to distributed intelligence schemes.	DOMA function	Distributed intelligence schemes	Transfer capacity of selected ties		Intra-Control Center
1.4.11		DOMA function, ADAVVCController	Analysis of distribution state estimation and power flow results	If analysis of power flow calculations detect a voltage or overload violation, VVC is initiated	DOMA function	ADAVVCController	Initiation of VVC		Intra-Control Center

2.1.2.5 DOMA Study/Look-ahead Mode

#	Event	Primary Actor	Name of Process/Activity	Description of Process/Activity	Information Producer	Information Receiver	Name of Info Exchanged	Additional Notes	IECSA Environments
#	<i>Triggering event: Identify the name of the event.⁶</i>	<i>What other actors are primarily responsible for the Process/Activity. Actors are defined in section 1.5.</i>	<i>Label that would appear in a process diagram. Use action verbs when naming activity.</i>	<i>Describe the actions that take place in active and present tense. The step should be a descriptive noun/verb phrase that portrays an outline summary of the step. "If ...Then...Else" scenarios can be captured as multiple Actions or as separate steps.</i>	<i>What other actors are primarily responsible for Producing the information. Actors are defined in section 1.5.</i>	<i>What other actors are primarily responsible for Receiving the information Actors are defined in section 1.5. (Note – May leave blank if same as Primary Actor)</i>	<i>Name of the information object. Information objects are defined in section 1.6</i>	<i>Elaborate architectural issues using attached spreadsheet. Use this column to elaborate details that aren't captured in the spreadsheet.</i>	<i>Reference the applicable IECSA Environment containing this data exchange. Only one environment per step.</i>
1.5.1	DOMA Study/Look Ahead Mode	AM_FM_GIS Database, ConversionValidationFunction	Data conversion and validation	Conversion and validation function receives the latest database download to extract, convert and validate circuit connectivity and transformer loading data (Stage 1) as well as to validate facility parameters via load flow and load transfer analyses (Stage 2).	AM_FM_GIS Database	ConversionValidationFunction	Connectivity, billing and facility parameters		Intra-Control Center
1.5.2		ConversionValidationFunction, ADADatabase	Data conversion and validation	Conversion and validation function updates AdvancedDistributionAutomationSystem database with the latest changes in AM_FM_GISDatabase.	ConversionValidationFunction	ADADatabase	Update of AdvancedDistributionAutomationSystem database		Intra-Control Center

⁶ Note – A triggering event is not necessary if the completion of the prior step leads to the transition of the following step.

#	Event	Primary Actor	Name of Process/Activity	Description of Process/Activity	Information Producer	Information Receiver	Name of Info Exchanged	Additional Notes	IECSA Environments
1.5.3		ADADispatchingSystem, DOMA function	Preparation of distribution system states as input for DOMA	ADADispatchingSystem, responsible, among other things, for triggering scheduled runs of various AdvancedDistributionAutomationSystem functions, issues a command to initiate the look-ahead mode.	ADADispatchingSystem	DOMA function	Command to initiate look-ahead mode.		Intra-Control Center
1.5.4		Regional System Operator, DOMA function	Preparation of distribution system states as input for DOMA	Regional System Operator gives the command to initiate the study mode.	Regional System Operator	DOMA function	Command to initiate study mode.		User Interface
1.5.5		WorkManagementSystem, DOMA function	Preparation of distribution system states as input for DOMA	DOMA receives information about the outages: present and future, which is reflected in preparation of distribution system state.	WorkManagementSystem	DOMA	Schedules presently active or authorized for future outages		Intra-Control Center
1.5.6		Environmental daily data collector, ADADatabase	AdvancedDistributionAutomationSystem database update	Environmental data for DER operation forecasting is updated in AdvancedDistributionAutomationSystem database.	Environmental daily data collector	ADADatabase	Environmental data for DER load and schedule forecast		Intra-Control Center

#	Event	Primary Actor	Name of Process/Activity	Description of Process/Activity	Information Producer	Information Receiver	Name of Info Exchanged	Additional Notes	IECSA Environments
1.5.7		ADADatabase, load forecaster	Preparation of distribution system states as input for DOMA	LoadForecaster receives distribution transformer daily loading data and environmental data for DER load to be used in preparation of distribution system state.	ADADatabase	LoadForecaster	Distribution transformers daily loading, environmental data for DER load and schedule forecasts		Intra-Control Center
1.5.8		LoadForecaster, DOMA function	Preparation of distribution system states as input for DOMA	DOMA receives the distribution transformer loading and DER operational forecasts needed for preparation of distribution system states to be studied in the study and look-ahead modes.	LoadForecaster	DOMA function	Distribution transformer loading and DER operational forecasts		Intra-Control Center
1.5.9		ADADatabase, DOMA function	Preparation of distribution system states as input for DOMA	DOMA receives the excerpts from AdvancedDistributionAutomationSystem database needed for preparation of distribution system states.	ADADatabase	DOMA function	Excerpts from AdvancedDistributionAutomationSystem database		Intra-Control Center

#	Event	Primary Actor	Name of Process/Activity	Description of Process/Activity	Information Producer	Information Receiver	Name of Info Exchanged	Additional Notes	IECSA Environments
1.5.10		DOMA function	Preparation of distribution system states as input for DOMA	Statuses and analogs associated with the given distribution system state are made available for study and look-ahead modes.	DOMA function	DOMA function	Statuses and analogs		Intra-Control Center
1.5.11		DOMA function	Checking distribution system state	The given distribution system state is checked for inconsistencies.	DOMA function	DOMA function	Input data for a given distribution system state		Intra-Control Center
1.5.12		DOMA function	Performing distribution state estimation and power flow calculations	DOMA function performs distribution power flow calculations making the results available for analyses.	DOMA function	DOMA function	Results of distribution state estimation and power flow calculations		Intra-Control Center
1.5.13		DOMA function, ADAHistoricDatabase	Analysis of distribution power flow calculations results	Analysis of the results of the distribution power flow calculations are made available for archiving.	DOMA function	ADAHistoric Database	Power flow results, dispatchable kW and kvar, bus voltage limits, customer extreme voltages and imbalances, losses, quality and fault analyses, alarms about load/voltage violations, logs.		Intra-Control Center

#	Event	Primary Actor	Name of Process/Activity	Description of Process/Activity	Information Producer	Information Receiver	Name of Info Exchanged	Additional Notes	IECSA Environments
1.5.14		DOMA function, Regional System Operator	Analysis of distribution power flow calculations results	Analysis of the results of the distribution power flow calculations are made available for the Regional System Operator.	DOMA function	Regional System Operator	DOMA status, dispatchable kW and kvar, bus voltage limits, customer extreme voltages and imbalances, alarms about load/voltage violations.		User Interface
1.5.15		DOMA function	Preparation of distribution system states as input for DOMA	Upon completion of analysis of the results of the distribution power flow calculations DOMA function issues a command to start the study of the next distribution system state.	DOMA function	DOMA function	Command to start the study of the next distribution system state.		Intra-Control Center

2.1.3 Steps – Alternative / Exception Sequences

Describe any alternative or exception sequences that may be required that deviate from the normal course of activities. Note instructions are found in previous table.

#	Event	Primary Actor	Name of Process/Activity	Description of Process/Activity	Information Producer	Information Receiver	Name of Info Exchanged	Additional Notes	IECSA Environments

2.1.4 Post-conditions and Significant Results

Describe conditions that must exist at the conclusion of the Function. Identify significant items similar to that in the preconditions section.

Describe any significant results from the Function

Actor/Activity	Post-conditions Description and Results
DOMA in real-time mode	DOMA generates pseudo-measurements for all distribution elements, reveals operational violations, aggregates operational parameters at the demarcation points between distribution and transmission, provides information for pre-arming of distributed intelligence schemes, determines currently available demand response including DER dispatch, prepares model updates for other AdvancedDistributionAutomationSystem-DER functions.
DOMA in look-ahead and study modes	DOMA predicts operational parameters for all distribution elements under expected in near-future and study conditions, operational violations, aggregates operational parameters at the demarcation points between distribution and transmission, determines available in near-future demand response including DER dispatch, prepares model for other AdvancedDistributionAutomationSystem-DER functions in study and look-ahead modes.

2.1.5 Diagrams

For clarification, draw (by hand, by Power Point, by UML diagram) the interactions, identifying the Steps where possible.

DATA CONVERSION AND VALIDATION

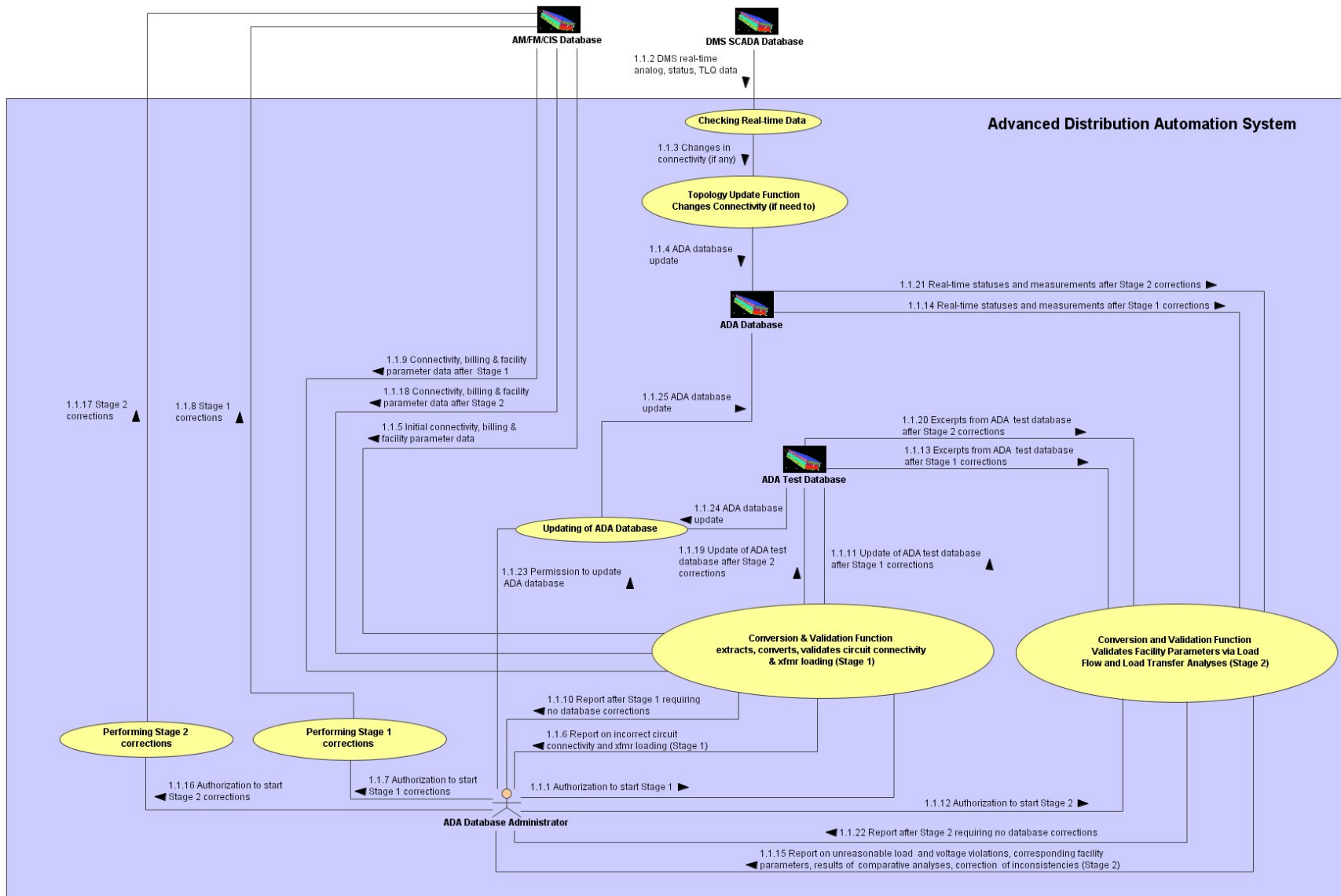

DOMA NO EVENTS

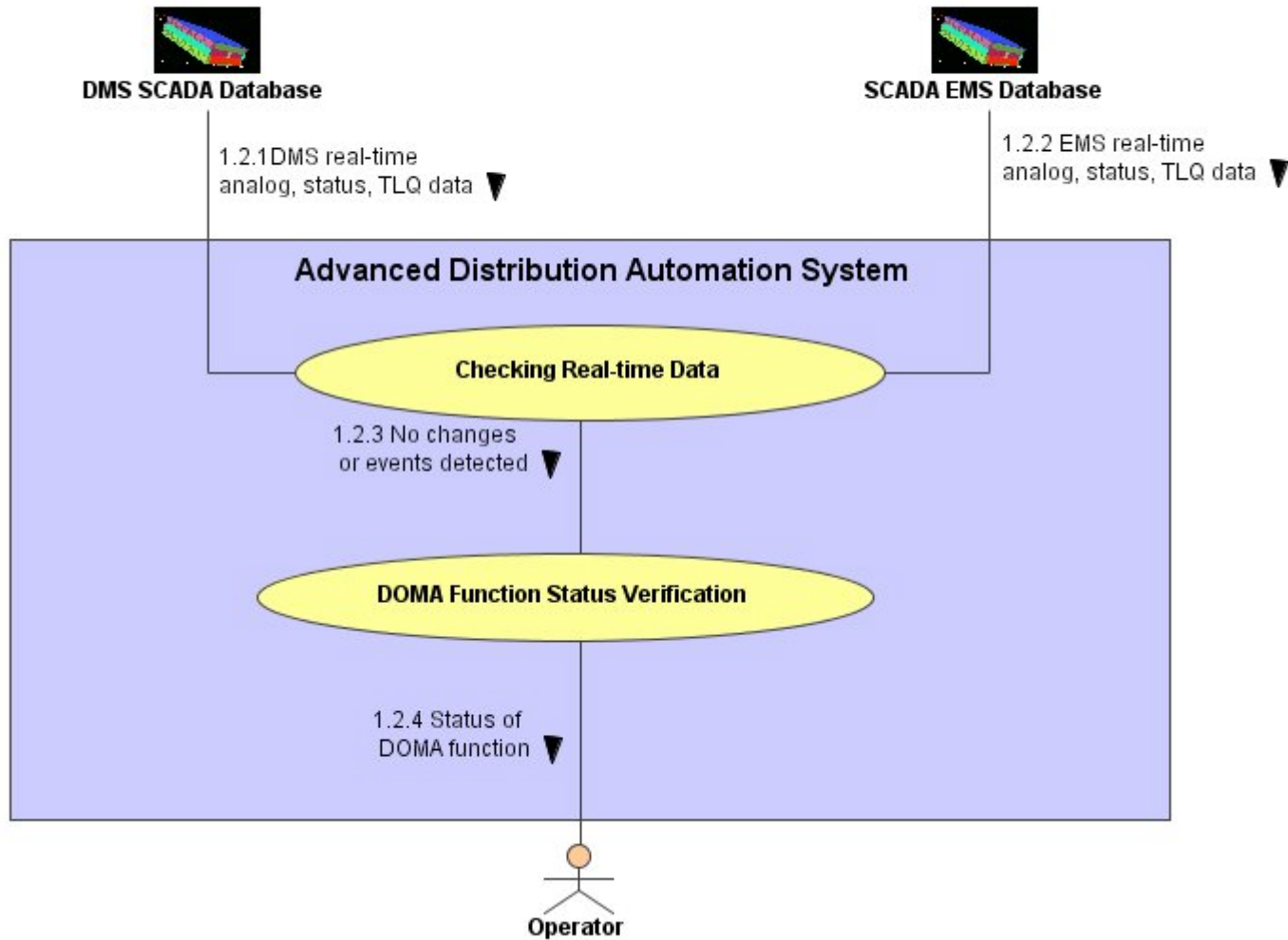

DOMA EVENT RUN

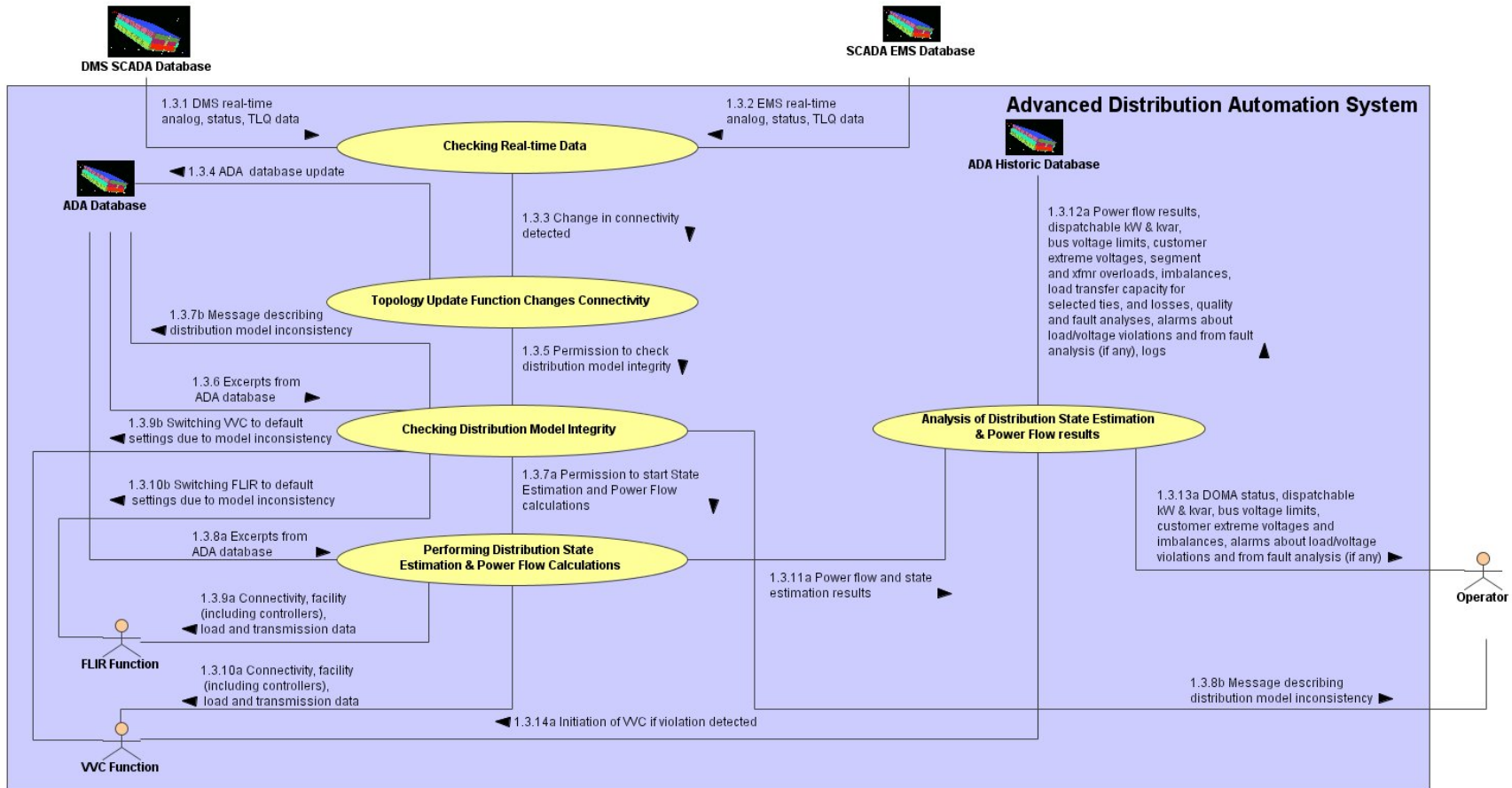

DOMA SCHEDULED RUN

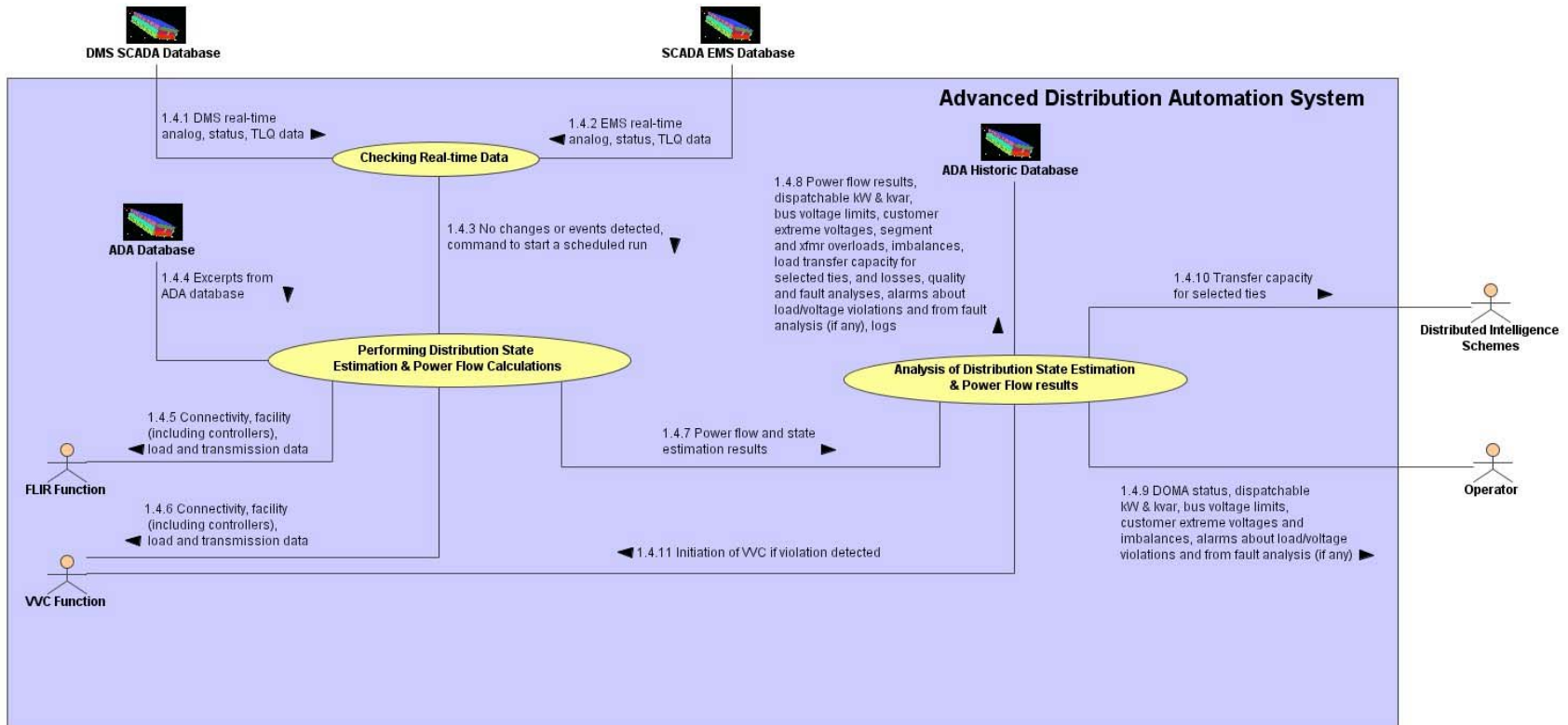

DOMA STUDY/LOOK-AHEAD MODE

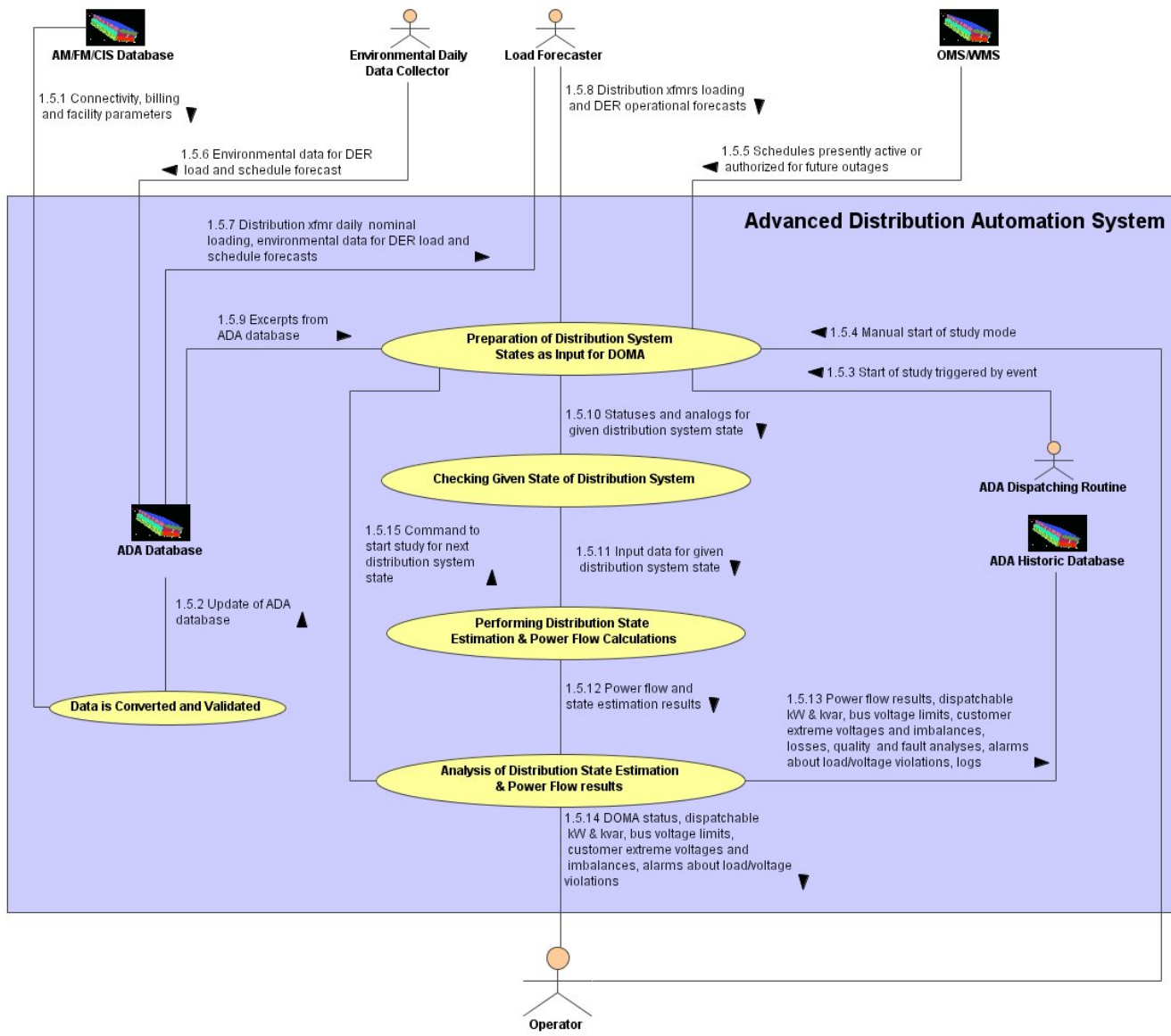

2.2 Fault Location, Isolation and Service Restoration (FLIR) Function

Name of this sequence.

2.2.1 FLIR Preconditions and Assumptions

Describe conditions that must exist prior to the initiation of the Function, such as prior state of the actors and activities

Identify any assumptions, such as what systems already exist, what contractual relations exist, and what configurations of systems are probably in place

Identify any initial states of information exchanged in the steps in the next section. For example, if a purchase order is exchanged in an activity, its precondition to the activity might be 'filled in but unapproved'.

<i>Actor/System/Information/Contract</i>	<i>Preconditions or Assumptions</i>
The same as for DOMA	The same as for DOMA
AdvancedDistributionAutomationSystem: Fault Location Isolation and Service Restoration (FLIR)	Fault Location Preconditions: DistributionSCADASystem with fault detectors, Distribution Operation Model and Analysis with fault analysis, fault location relays (schemes) including high impedance relays and Some Distributed Intelligence schemes and Trouble call system exist. Fault Isolation and Service Restoration Preconditions: DistributionSCADASystem with ability to control a defined number of switching devices, Fault Location, Distribution Operation Model and Analysis, Voltage and Var Control for adjusting voltage and var after reconfiguration. Supervisory and closed-loop control of switches are available. Some Distributed Intelligence schemes exist.
OutageManagementSystem	<u>Outage Management System is interfaced with SCADA and AdvancedDistributionAutomationSystem and supports a dynamic topology model.</u>
EnergyManagementSystem (WAMACS)	<u>EnergyManagementSystem is interfaced with WAMACS and AdvancedDistributionAutomationSystem and provides phasor data for all distribution (reference) buses.</u>
Regional System Operator	<u>Regional System Operator has AdvancedDistributionAutomationSystem GUI and uses it for supervisory control of switches, for entering pseudo-SCADA statuses, selecting isolation and restoration alternatives, etc. The operator also has the ability to communicate with the field crews via mobile communications and computing.</u>
FieldPersonnel	<u>FieldPersonnels are able to communicate with the operator via mobile communications and computing</u>
Distributed Intelligence Schemes	<u>DIS team members are able to operate in a coordinated manner based on peer-to-peer communications or based on operational parameters, and DIS team masters are able to communicate via fast peer-to-peer communications</u>
AdvancedDistributionAutomationSystem: Prearming of Remedial Action Schemes application	<u>The pre-arming application downloads operating conditions to DIS masters based on DOMA results</u>
Historic DB	<u>Historic database is able to store large amount of data about outages, which will be used by the outage</u>

<i>Actor/System/Information/Contract</i>	<i>Preconditions or Assumptions</i>
	<u>statistic application and other users.</u>
Environmental daily data collector	Environmental daily data collector collects environmental data used for DER schedule forecast.
ADATopologyUpdateSystem	ADATopologyUpdateSystem changes connectivity in AdvancedDistributionAutomationSystem database based on changes detected in real-time DMS and EnergyManagementSystem SCADA.
Fault location function	Fault-locating function provides distances to fault location, which are used by operator or FLIR function, along with other relevant data, to guide activities of field crews.

2.2.2 FLIR Steps – Normal Sequence

Describe the normal sequence of events, focusing on steps that identify new types of information or new information exchanges or new interface issues to address. Should the sequence require detailed steps that are also used by other functions, consider creating a new “sub” function, then referring to that “subroutine” in this function. Remember that the focus should be less on the algorithms of the applications and more on the interactions and information flows between “entities”, e.g. people, systems, applications, data bases, etc. There should be a direct link between the narrative and these steps.

The numbering of the sequence steps conveys the order and concurrency and iteration of the steps occur. Using a Dewey Decimal scheme, each level of nested procedure call is separated by a dot ‘.’. Within a level, the sequence number comprises an optional letter and an integer number. The letter specifies a concurrent sequence within the next higher level; all letter sequences are concurrent with other letter sequences. The number specifies the sequencing of messages in a given letter sequence. The absence of a letter is treated as a default ‘main sequence’ in parallel with the lettered sequences.

Sequence 1:

```

1.1 - Do step 1
1.2A.1 - In parallel to activity 2 B do step 1
1.2A.2 - In parallel to activity 2 B do step 2
1.2B.1 - In parallel to activity 2 A do step 1
1.2B.2 - In parallel to activity 2 A do step 2
1.3 - Do step 3
1.3.1 - nested step 3.1
1.3.2 - nested step 3.2

```

Sequence 2:

- 2.1 - Do step 1
- 2.2 - Do step 2

2.2.2.1 FLIR First Fault with Only Manual Switches

#	Event	Primary Actor	Name of Process/Activity	Description of Process/Activity	Information Producer	Information Receiver	Name of Info Exchanged	Additional Notes	IECSA Environments
#	<i>Triggering event? Identify the name of the event.⁷</i>	<i>What other actors are primarily responsible for the Process/Activity? Actors are defined in section 1.5.</i>	<i>Label that would appear in a process diagram. Use action verbs when naming activity.</i>	<i>Describe the actions that take place in active and present tense. The step should be a descriptive noun/verb phrase that portrays an outline summary of the step. "If ...Then...Else" scenarios can be captured as multiple Actions or as separate steps.</i>	<i>What other actors are primarily responsible for Producing the information? Actors are defined in section 1.5.</i>	<i>What other actors are primarily responsible for Receiving the information? Actors are defined in section 1.5. (Note – May leave blank if same as Primary Actor)</i>	<i>Name of the information object. Information objects are defined in section 1.6</i>	<i>Elaborate architectural issues using attached spreadsheet. Use this column to elaborate details that aren't captured in the spreadsheet.</i>	<i>Reference the applicable IECSA Environment containing this data exchange. Only one environment per step.</i>
2.1.1	FLIR first fault with only manual switches	DMS SCADA database, DOMA function	Checking real-time data	DOMA function receives the scan of DMS SCADA data to be checked for changes in topology. It also provides the latest relevant analog data.	DMS SCADA database	DOMA function	DMS real-time analog, status & TLQ data		Intra-Control Center
2.1.2		EnergyManagementSystem SCADA database, DOMA function	Checking real-time data	DOMA function receives the scan of EnergyManagementSystem SCADA data to be checked for relevant changes or events.	EnergyManagementSystem SCADA database	DOMA function	EnergyManagementSystem real-time analog, status, TLQ data		Intra-Control Center

⁷ Note – A triggering event is not necessary if the completion of the prior step – leads to the transition of the following step.

#	Event	Primary Actor	Name of Process/Activity	Description of Process/Activity	Information Producer	Information Receiver	Name of Info Exchanged	Additional Notes	IECSA Environments
2.1.3		Environmental daily data collector, DOMA function	Checking real-time data	DOMA function receives the scan of environmental data to be checked for changes affecting DER performance forecast.	Environmental daily data collector	DOMA function	Real-time environmental data for DER schedule forecast		Intra-Control Center
2.1.4		OutageManagementSystem, DOMA function	Checking real-time data	DOMA function receives the scan of latest schedules of presently active or authorized for future outages to be checked for changes during the time of repair.	OutageManagementSystem	DOMA function	Schedules of presently active or authorized for future outages		Intra-Control Center
2.1.5		DOMA function, ADATopologyUpdateSystem	ADATopologyUpdateSystem changes connectivity	After DOMA detects fault in distribution, relevant information is provided to topology function.	DOMA function	ADATopologyUpdateSystem	Circuit breaker lockouts, inputs from OutageManagementSystem		Intra-Control Center
2.1.6		ADATopologyUpdateSystem, ADADatabase	ADATopologyUpdateSystem changes connectivity	After fault is detected, AdvancedDistributionAutomationSystem database is updated.	ADATopologyUpdateSystem	ADADatabase	Update of AdvancedDistributionAutomationSystem database		Intra-Control Center

#	Event	Primary Actor	Name of Process/Activity	Description of Process/Activity	Information Producer	Information Receiver	Name of Info Exchanged	Additional Notes	IECSA Environments
2.1.7		ADATopologyUpdateSystem, FLIR function	Fault location sub-function identifies fault-related protective devices and de-energized sections	Topology function initiates fault location sub-function of the FLIR function.	ADATopologyUpdateSystem	FLIR function	Fault location sub-function initiation		Intra-Control Center
2.1.8		ADADatabase, FLIR function	Fault location sub-function identifies fault-related protective devices and de-energized sections	Fault location sub-function receives the needed data from AdvancedDistributionAutomationSystem database after it was updated with fault information.	ADADatabase	FLIR function	Excerpts from AdvancedDistributionAutomationSystem database updated after fault detection		Intra-Control Center
2.1.9		FLIR function, Regional System Operator	Fault location sub-function identifies fault-related protective devices and de-energized sections	Fault location sub-function provides the Regional System Operator with information needed for him to make operational decisions, i.e., dispatching the field crew, etc.	FLIR function	Regional System Operator	Circuit breaker lockouts, inputs from OutageManagementSystem, fault-related de-energized sections		User Interface
2.1.10		Fault location function, Regional System Operator	Fault-location relay informs Regional System Operator	Regional System Operator receives distances to fault location provided by the fault location relay.	Fault location function	Regional System Operator	Distances to fault location		User Interface

#	Event	Primary Actor	Name of Process/Activity	Description of Process/Activity	Information Producer	Information Receiver	Name of Info Exchanged	Additional Notes	IECSA Environments
2.1.12		Regional System Operator, field crew	Regional System Operator informs field crew	Regional System Operator authorizes to patrol the faulted line to locate fault and perform binary search if needed.	Regional System Operator	Field Personnel	Authorization to patrol faulted line		User Interface
2.1.13		Field Personnel, Regional System Operator	Field Personnel informs Regional System Operator	After locating the fault, the crew informs the Regional System Operator about the status of switches involved in initial fault isolation.	Field Personnel	Regional System Operator	Status of switches involved in initial fault isolation		User Interface
2.1.14, 2.1.15		Regional System Operator	Entering status of switches and faulted section into Advanced Distribution Automation System database	The Regional System Operator enters status of switches (pseudo-statuses) involved in initial fault isolation and the faulted section into Advanced Distribution Automation System database.	Regional System Operator	ADADatabase	Advanced Distribution Automation System database update after initial fault isolation		User Interface

#	Event	Primary Actor	Name of Process/Activity	Description of Process/Activity	Information Producer	Information Receiver	Name of Info Exchanged	Additional Notes	IECSA Environments
2.1.16		Regional System Operator, FLIR function	Fault isolation and service restoration sub-function generates list of recommended switching orders	By entering the faulted section into the AdvancedDistributionAutomationSystem database, the Regional System Operator initiates fault isolation and service restoration sub-function.	Regional System Operator	FLIR	Initiation of fault isolation and service restoration sub-function		User Interface
2.1.17		ADADatabase, FLIR function	Fault isolation and service restoration sub-function generates list of recommended switching orders	Fault isolation and service restoration sub-function receives AdvancedDistributionAutomationSystem database excerpts updated after initial fault isolation.	ADADatabase	FLIR function	AdvancedDistributionAutomationSystem database excerpts updated after initial fault isolation		Intra-Control Center
2.1.18		FLIR function, ADAHistoricDatabase	Fault isolation and service restoration sub-function generates list of recommended switching orders	FLIR issues a report for archiving in AdvancedDistributionAutomationSystem historic database	FLIR function	ADAHistoric Database	Report including interrupted, unserved and restored load, and number of customers		Intra-Control Center

#	Event	Primary Actor	Name of Process/Activity	Description of Process/Activity	Information Producer	Information Receiver	Name of Info Exchanged	Additional Notes	IECSA Environments
2.1.19		FLIR function, Regional System Operator	Fault isolation and service restoration sub-function generates list of recommended switching orders	A generated list of recommended switching orders is presented to the Regional System Operator.	FLIR function	Regional System Operator	List of recommended switching orders		User Interface
2.1.20		Regional System Operator, field crew	Regional System Operator informs field crew	Regional System Operator selects a switching order and authorizes its implementation.	Regional System Operator	Field Personnel	Switching order authorized for implementation		User Interface
2.1.21		Field Personnel, Regional System Operator	Field Personnel informs Regional System Operator	Upon final isolation and service restoration to healthy sections, the field crew informs the Regional System Operator about final status of relevant switches (cuts).	Field Personnel	Regional System Operator	Status of switches involved in final fault isolation and service restoration to healthy sections.		User Interface

#	Event	Primary Actor	Name of Process/Activity	Description of Process/Activity	Information Producer	Information Receiver	Name of Info Exchanged	Additional Notes	IECSA Environments
2.1.22, 2.1.23		Regional System Operator	Entering status of switches involved in final fault isolation and service restoration to healthy sections into Advanced Distribution Automation System database	The Regional System Operator enters status of switches/cuts (pseudo-statuses) involved in final fault isolation and service restoration to healthy sections into Advanced Distribution Automation System database	Regional System Operator	ADADatabase	Advanced Distribution Automation System database update after final fault isolation and service restoration		User Interface
2.1.24		FLIR	FLIR updates the switching order in accord with the final fault isolation	Regional System Operator receives the final switching order from FLIR and dispatched the crew to implement it	FLIR, Regional System Operator	Regional System Operator, Field Personnel	Switching order, instructions to the crew		User Interface

2.2.2.2 FLIR Second Fault (Related to First Fault which is Not Resolved Yet) with Only Manual Switches

#	Event	Primary Actor	Name of Process/Activity	Description of Process/Activity	Information Producer	Information Receiver	Name of Info Exchanged	Additional Notes	IECSA Environments
#	<i>Triggering event? Identify the name of the event.⁸</i>	<i>What other actors are primarily responsible for the Process/Activity? Actors are defined in section 1.5.</i>	<i>Label that would appear in a process diagram. Use action verbs when naming activity.</i>	<i>Describe the actions that take place in active and present tense. The step should be a descriptive noun/verb phrase that portrays an outline summary of the step. "If ...Then...Else" scenarios can be captured as multiple Actions or as separate steps.</i>	<i>What other actors are primarily responsible for Producing the information? Actors are defined in section 1.5.</i>	<i>What other actors are primarily responsible for Receiving the information? Actors are defined in section 1.5. (Note – May leave blank if same as Primary Actor)</i>	<i>Name of the information object. Information objects are defined in section 1.6</i>	<i>Elaborate architectural issues using attached spreadsheet. Use this column to elaborate details that aren't captured in the spreadsheet.</i>	<i>Reference the applicable IECSA Environment containing this data exchange. Only one environment per step.</i>
2.2.1	FLIR second fault (related to first fault which is not resolved yet) with only manual switches	DMS SCADA database, DOMA function	Checking real-time data	DOMA function receives the scan of DMS SCADA data to be checked for changes in topology. It also provides the latest relevant analog data.	DMS SCADA database	DOMA function	DMS real-time analog, status & TLQ data at time of first fault		Intra-Control Center
2.2.2		EnergyManagementSystem SCADA database, DOMA function	Checking real-time data	DOMA function receives the scan of EnergyManagementSystem SCADA data to be checked for relevant changes or events.	EnergyManagementSystem SCADA database	DOMA function	EnergyManagementSystem real-time analog, status, TLQ data at time of first fault		Intra-Control Center

⁸ Note – A triggering event is not necessary if the completion of the prior step – leads to the transition of the following step.

#	Event	Primary Actor	Name of Process/Activity	Description of Process/Activity	Information Producer	Information Receiver	Name of Info Exchanged	Additional Notes	IECSA Environments
2.2.3		Environmental daily data collector, DOMA function	Checking real-time data	DOMA function receives the scan of environmental data to be checked for changes affecting DER performance forecast.	Environmental daily data collector	DOMA function	Real-time environmental data for DER schedule forecast at time of first fault		Intra-Control Center
2.2.4		OutageManagementSystem, DOMA function	Checking real-time data	DOMA function receives the scan of latest schedules of presently active or authorized for future outages to be checked for changes.	OutageManagementSystem	DOMA function	Schedules of presently active or authorized for future outages at time of first fault		Intra-Control Center
2.2.5		DOMA function, ADATopologyUpdateSystem	ADATopologyUpdateSystem changes connectivity	After DOMA detects first fault in distribution, relevant information is provided to topology function.	DOMA function	ADATopologyUpdateSystem	First fault: circuit breaker lockouts, inputs from OutageManagementSystem		Intra-Control Center
2.2.6		ADATopologyUpdateSystem, ADADatabase	ADATopologyUpdateSystem changes connectivity	After first fault is detected, AdvancedDistributionAutomationSystem database is updated.	ADATopologyUpdateSystem	ADADatabase	Update of AdvancedDistributionAutomationSystem database after first fault detection		Intra-Control Center

#	Event	Primary Actor	Name of Process/Activity	Description of Process/Activity	Information Producer	Information Receiver	Name of Info Exchanged	Additional Notes	IECSA Environments
2.2.7		ADATopologyUpdateSystem, FLIR function	Fault location sub-function identifies fault-related protective devices and de-energized sections	After the first fault is detected, topology function initiates fault location sub-function of the FLIR function.	ADATopologyUpdateSystem	FLIR function	Fault location sub-function initiation after first fault		Intra-Control Center
2.2.8		ADADatabase, FLIR function	Fault location sub-function identifies fault-related protective devices and de-energized sections	Fault location sub-function receives the needed data from AdvancedDistributionAutomationSystem database after it was updated with the first fault information.	ADADatabase	FLIR function	Excerpts from AdvancedDistributionAutomationSystem database updated after first fault detection		Intra-Control Center

#	Event	Primary Actor	Name of Process/Activity	Description of Process/Activity	Information Producer	Information Receiver	Name of Info Exchanged	Additional Notes	IECSA Environments
2.2.9		FLIR function, Regional System Operator	Fault location sub-function identifies fault-related protective devices and de-energized sections	Fault location sub-function provides the Regional System Operator with information on the first fault needed for him to make operational decisions, i.e., dispatching the field crew, etc.	FLIR function	Regional System Operator	First fault: circuit breaker lockouts, inputs from OutageManagementSystem, fault-related de-energized sections		User Interface
2.2.10		Regional System Operator, field crew	Regional System Operator informs field crew	Regional System Operator authorizes to patrol the faulted line to locate first fault and perform binary search if needed.	Regional System Operator	FieldPersonnel	Authorization to patrol faulted line to locate first fault		User Interface
2.2.11		FieldPersonnel, Regional System Operator	FieldPersonnel informs Regional System Operator	After locating the first fault, the crew informs the Regional System Operator about the status of switches involved in initial fault isolation.	FieldPersonnel	Regional System Operator	Status of switches involved in initial first fault isolation		User Interface

#	Event	Primary Actor	Name of Process/Activity	Description of Process/Activity	Information Producer	Information Receiver	Name of Info Exchanged	Additional Notes	IECSA Environments
2.2.12, 2.2.13		Regional System Operator	Entering status of switches and faulted section into Advanced Distribution Automation System database	The Regional System Operator enters status of switches (pseudo-statuses) involved in initial first fault isolation and the faulted section into Advanced Distribution Automation System database.	Regional System Operator	ADA Database	Advanced Distribution Automation System database update after initial isolation of first fault		User Interface
2.2.14		Regional System Operator, FLIR function	Fault isolation and service restoration sub-function generates list of recommended switching orders	By entering the faulted section, associated with first fault, into the Advanced Distribution Automation System database, the Regional System Operator initiates fault isolation and service restoration sub-function.	Regional System Operator	FLIR	Initiation of fault isolation and service restoration sub-function		User Interface

#	Event	Primary Actor	Name of Process/Activity	Description of Process/Activity	Information Producer	Information Receiver	Name of Info Exchanged	Additional Notes	IECSA Environments
2.2.15		ADADatabase, FLIR function	Fault isolation and service restoration sub-function generates list of recommended switching orders	Fault isolation and service restoration sub-function receives AdvancedDistributionAutomationSystem database excerpts updated after initial first fault isolation.	ADADatabase	FLIR function	AdvancedDistributionAutomationSystem database excerpts updated after initial isolation of first fault		Intra-Control Center
2.2.16		FLIR function, ADAHistoricDatabase	Fault isolation and service restoration sub-function generates list of recommended switching orders	FLIR issues a report after the first fault for archiving in AdvancedDistributionAutomationSystem historic database	FLIR function	ADAHistoric Database	Report including interrupted, unserved and restored load, and number of customers after first fault		Intra-Control Center

#	Event	Primary Actor	Name of Process/Activity	Description of Process/Activity	Information Producer	Information Receiver	Name of Info Exchanged	Additional Notes	IECSA Environments
2.2.17		FLIR function, Regional System Operator	Fault isolation and service restoration sub-function generates list of recommended switching orders	A generated list of recommended switching orders related to first fault is presented to the Regional System Operator.	FLIR function	Regional System Operator	List of recommended switching orders related to first fault		User Interface
2.2.18	FLIR second fault (related to first fault which is not resolved yet) with only manual switches	DMS SCADA database, DOMA function	Checking real-time data	DOMA function receives the scan of DMS SCADA data to be checked for changes in topology. It also provides the latest relevant analog data.	DMS SCADA database	DOMA function	DMS real-time analog, status & TLQ data at time of second fault		Intra-Control Center
2.2.19		EnergyManagementSystem SCADA database, DOMA function	Checking real-time data	DOMA function receives the scan of EnergyManagementSystem SCADA data to be checked for relevant changes or events.	EnergyManagementSystem SCADA database	DOMA function	EnergyManagementSystem real-time analog, status, TLQ data at time of second fault		Intra-Control Center

#	Event	Primary Actor	Name of Process/Activity	Description of Process/Activity	Information Producer	Information Receiver	Name of Info Exchanged	Additional Notes	IECSA Environments
2.2.20		Environmental daily data collector, DOMA function	Checking real-time data	DOMA function receives the scan of environmental data to be checked for changes affecting DER performance forecast.	Environmental daily data collector	DOMA function	Real-time environmental data for DER schedule forecast at time of second fault		Intra-Control Center
2.2.21		OutageManagementSystem, DOMA function	Checking real-time data	DOMA function receives the scan of latest schedules of presently active or authorized for future outages to be checked for changes.	OutageManagementSystem	DOMA function	Schedules of presently active or authorized for future outages at time of second fault		Intra-Control Center
2.2.22		DOMA function, ADATopologyUpdateSystem	ADATopologyUpdateSystem changes connectivity	After DOMA detects second fault in distribution, relevant information is provided to topology function.	DOMA function	ADATopologyUpdateSystem	Second fault: circuit breaker lockouts, inputs from OutageManagementSystem		Intra-Control Center
2.2.23		ADATopologyUpdateSystem, ADADatabase	ADATopologyUpdateSystem changes connectivity	After second fault is detected, AdvancedDistributionAutomationSystem database is updated.	ADATopologyUpdateSystem	ADADatabase	Update of AdvancedDistributionAutomationSystem database after second fault detection		Intra-Control Center

#	Event	Primary Actor	Name of Process/Activity	Description of Process/Activity	Information Producer	Information Receiver	Name of Info Exchanged	Additional Notes	IECSA Environments
2.2.24		ADATopologyUpdateSystem, FLIR function	Fault location sub-function identifies fault-related protective devices and de-energized sections	After the second fault is detected, topology function initiates fault location sub-function of the FLIR function.	ADATopologyUpdateSystem	FLIR function	Fault location sub-function initiation after second fault		Intra-Control Center
2.2.25		ADADatabase, FLIR function	Fault location sub-function identifies fault-related protective devices and de-energized sections	Fault location sub-function receives the needed data from AdvancedDistributionAutomationSystem database after it was updated with the second fault information.	ADADatabase	FLIR function	Excerpts from AdvancedDistributionAutomationSystem database updated after second fault detection		Intra-Control Center

#	Event	Primary Actor	Name of Process/Activity	Description of Process/Activity	Information Producer	Information Receiver	Name of Info Exchanged	Additional Notes	IECSA Environments
2.2.26		FLIR function	Fault isolation and service restoration sub-function determines whether second fault impacts switching for first fault	Fault isolation and service restoration sub-function determines whether second fault impacts switching for first fault.	FLIR function	FLIR function	Second fault: circuit breaker lockouts, inputs from OutageManagementSystem, fault-related de-energized sections		Intra-Control Center
2.2.27		FLIR function	Fault isolation and service restoration sub-function determines whether second fault impacts switching for first fault	Fault isolation and service restoration sub-function cancels the previous switching order if it needs to.	FLIR function	Regional System Operator	Cancellation of first-fault-related switching order		User Interface

#	Event	Primary Actor	Name of Process/Activity	Description of Process/Activity	Information Producer	Information Receiver	Name of Info Exchanged	Additional Notes	IECSA Environments
2.2.28		Regional System Operator, field crew	Regional System Operator informs field crew	Regional System Operator authorizes to patrol the faulted line to locate second fault and perform binary search if needed.	Regional System Operator	Field Personnel	Authorization to patrol faulted line to locate second fault		User Interface
2.2.29		Field Personnel, Regional System Operator	Field Personnel informs Regional System Operator	After locating the second fault, the crew informs the Regional System Operator about the status of switches involved in initial second fault isolation.	Field Personnel	Regional System Operator	Status of switches involved in initial second fault isolation		User Interface
2.2.30, 2.2.31		Regional System Operator	Entering status of switches and faulted section into Advanced Distribution Automation System database	The Regional System Operator enters status of switches (pseudo-statuses) involved in initial second fault isolation and the faulted section into Advanced Distribution Automation System database.	Regional System Operator	ADA Database	Advanced Distribution Automation System database update after initial isolation of second fault		User Interface

#	Event	Primary Actor	Name of Process/Activity	Description of Process/Activity	Information Producer	Information Receiver	Name of Info Exchanged	Additional Notes	IECSA Environments
2.2.32		Regional System Operator, FLIR function	Fault isolation and service restoration sub-function generates list of recommended switching orders	By entering the faulted section, associated with second fault, into the AdvancedDistributionAutomationSystem database, the Regional System Operator initiates fault isolation and service restoration sub-function for both faults.	Regional System Operator	FLIR	Initiation of fault isolation and service restoration sub-function		User Interface
2.2.33		ADADatabase, FLIR function	Fault isolation and service restoration sub-function generates list of recommended switching orders	Fault isolation and service restoration sub-function receives AdvancedDistributionAutomationSystem database excerpts updated after initial second fault isolation.	ADADatabase	FLIR function	AdvancedDistributionAutomationSystem database excerpts updated after initial isolation of second fault		Intra-Control Center

#	Event	Primary Actor	Name of Process/Activity	Description of Process/Activity	Information Producer	Information Receiver	Name of Info Exchanged	Additional Notes	IECSA Environments
2.2.34		FLIR function, ADAHistoricDatabase	Fault isolation and service restoration sub-function generates list of recommended switching orders	FLIR issues a report after the second fault for archiving in AdvancedDistributionAutomationSystem historic database	FLIR function	ADAHistoric Database	Report including interrupted, unserved and restored load, and number of customers after second fault		Intra-Control Center
2.2.35		FLIR function, Regional System Operator	Fault isolation and service restoration sub-function generates list of recommended switching orders	A generated list of recommended switching orders related to both faults is presented to the Regional System Operator.	FLIR function	Regional System Operator	List of recommended switching orders related to second fault		User Interface
2.2.36		Regional System Operator, field crew	Regional System Operator informs field crew	Regional System Operator selects a switching order and authorizes its implementation.	Regional System Operator	FieldPersonnel	Switching order authorized for implementation after second fault		User Interface

#	Event	Primary Actor	Name of Process/Activity	Description of Process/Activity	Information Producer	Information Receiver	Name of Info Exchanged	Additional Notes	IECSA Environments
2.2.37		Field Personnel, Regional System Operator	Field Personnel informs Regional System Operator	Upon final isolation and service restoration to healthy sections, the field crew informs the Regional System Operator about final status of relevant switches for the second fault.	Field Personnel	Regional System Operator	Status of switches involved in final fault isolation and service restoration to healthy sections after second fault.		User Interface
2.2.38, 2.2.39		Regional System Operator	Entering status of switches involved in final fault isolation and service restoration to healthy sections into Advanced Distribution Automation System database	The Regional System Operator enters status of switches (pseudo-statuses) involved in final fault isolation and service restoration to healthy sections into Advanced Distribution Automation System database	Regional System Operator	ADA Database	Advanced Distribution Automation System database update after final fault isolation and service restoration		User Interface

#	Event	Primary Actor	Name of Process/Activity	Description of Process/Activity	Information Producer	Information Receiver	Name of Info Exchanged	Additional Notes	IECSA Environments
2.2.40	FLIR	FLIR updates the switching order in accord with the final isolation of both faults	Regional System Operator receives the final switching order from FLIR and dispatched the crew to implement it	FLIR, Regional System Operator	Regional System Operator	Field Personnel	Switching order, instructions to the crew		User Interface

2.2.2.3 FLIR Fault with Remotely-Controlled and Manual Switches

#	Event	Primary Actor	Name of Process/Activity	Description of Process/Activity	Information Producer	Information Receiver	Name of Info Exchanged	Additional Notes	IECSA Environments
#	<i>Triggering event? Identify the name of the event.⁹</i>	<i>What other actors are primarily responsible for the Process/Activity? Actors are defined in section 1.5.</i>	<i>Label that would appear in a process diagram. Use action verbs when naming activity.</i>	<i>Describe the actions that take place in active and present tense. The step should be a descriptive noun/verb phrase that portrays an outline summary of the step. "If ...Then...Else" scenarios can be captured as multiple Actions or as separate steps.</i>	<i>What other actors are primarily responsible for Producing the information? Actors are defined in section 1.5.</i>	<i>What other actors are primarily responsible for Receiving the information? Actors are defined in section 1.5. (Note – May leave blank if same as Primary Actor)</i>	<i>Name of the information object. Information objects are defined in section 1.6</i>	<i>Elaborate architectural issues using attached spreadsheet. Use this column to elaborate details that aren't captured in the spreadsheet.</i>	<i>Reference the applicable IECSA Environment containing this data exchange. Only one environment per step.</i>

⁹ Note – A triggering event is not necessary if the completion of the prior step – leads to the transition of the following step.

#	Event	Primary Actor	Name of Process/Activity	Description of Process/Activity	Information Producer	Information Receiver	Name of Info Exchanged	Additional Notes	IECSA Environments
2.3.1	FLIR fault with remotely-controlled and manual switches	DMS SCADA database, DOMA function	Checking real-time data	DOMA function receives the scan of DMS SCADA data to be checked for changes in topology. It also provides the latest relevant analog data.	DMS SCADA database	DOMA function	DMS real-time analog, status & TLQ data		Intra-Control Center
2.3.2		EnergyManagementSystem SCADA database, DOMA function	Checking real-time data	DOMA function receives the scan of EnergyManagementSystem SCADA data to be checked for relevant changes or events.	EnergyManagementSystem SCADA database	DOMA function	EnergyManagementSystem real-time analog, status, TLQ data		Intra-Control Center
2.3.3		Environmental daily data collector, DOMA function	Checking real-time data	DOMA function receives the scan of environmental data to be checked for changes affecting DER performance forecast.	Environmental daily data collector	DOMA function	Real-time environmental data for DER schedule forecast		Intra-Control Center
2.3.4		OutageManagementSystem, DOMA function	Checking real-time data	DOMA function receives the scan of latest schedules of presently active or authorized for future outages to be checked for changes.	OutageManagementSystem	DOMA function	Schedules of presently active or authorized for future outages		Intra-Control Center

#	Event	Primary Actor	Name of Process/Activity	Description of Process/Activity	Information Producer	Information Receiver	Name of Info Exchanged	Additional Notes	IECSA Environments
2.3.5		Fault location function, DOMA function	Checking real-time data	DOMA function receives the distance to fault location, which is provided by Fault location function in the presence of the fault.	Fault location function	DOMA function	Distance to fault location		Intra-Control Center
2.3.6		DOMA function, ADATopologyUpdateSystem	ADATopologyUpdateSystem changes connectivity	After DOMA detects fault in distribution, relevant information is provided to topology function.	DOMA function	ADATopologyUpdateSystem	Circuit breaker lockouts, inputs from OutageManagementSystem		Intra-Control Center
2.3.7		ADATopologyUpdateSystem, ADADatabase	ADATopologyUpdateSystem changes connectivity	After fault is detected, AdvancedDistributionAutomationSystem database is updated.	ADATopologyUpdateSystem	ADADatabase	Update of AdvancedDistributionAutomationSystem database		Intra-Control Center

#	Event	Primary Actor	Name of Process/Activity	Description of Process/Activity	Information Producer	Information Receiver	Name of Info Exchanged	Additional Notes	IECSA Environments
2.3.8		ADATopologyUpdateSystem, FLIR function	Fault location sub-function identifies fault-related protective devices and de-energized sections	Topology function initiates fault location sub-function of the FLIR function.	ADATopologyUpdateSystem	FLIR function	Fault location subfunction initiation		Intra-Control Center
2.3.9		ADADatabase, FLIR function	Fault location subfunction identifies fault-related protective devices and de-energized sections	Fault location subfunction receives the needed data from AdvancedDistributionAutomationSystem database after it was updated with fault information.	ADADatabase	FLIR function	Excerpts from AdvancedDistributionAutomation System database updated after fault detection		Intra-Control Center

#	Event	Primary Actor	Name of Process/Activity	Description of Process/Activity	Information Producer	Information Receiver	Name of Info Exchanged	Additional Notes	IECSA Environments
2.3.10		FLIR function	Fault isolation and service restoration sub-function generates list of recommended switching orders	Fault location subfunction initiates fault isolation and service restoration sub-function of the FLIR function.	Fault location function	Fault isolation and service restoration subfunction	Fault isolation and service restoration sub-function initiation, probable fault location with alternatives		Intra-Control Center
2.3.11		ADADatabase, FLIR function	Fault isolation and service restoration sub-function generates list of recommended switching orders	Fault isolation and service restoration sub-function receives AdvancedDistributionAutomationSystem database excerpts updated with fault information.	ADADatabase	FLIR function	AdvancedDistributionAutomationSystem database excerpts		Intra-Control Center

#	Event	Primary Actor	Name of Process/Activity	Description of Process/Activity	Information Producer	Information Receiver	Name of Info Exchanged	Additional Notes	IECSA Environments
2.3.12		FLIR function, ADAHistoricDatabase	Fault isolation and service restoration sub-function generates list of recommended switching orders	FLIR issues a report for archiving in AdvancedDistributionAutomationSystem historic database.	FLIR function	ADAHistoric Database	Report including interrupted, unserved and restored load, and number of customers before additional fault isolation		Intra-Control Center
2.3.13a		FLIR function, Regional System Operator	Fault isolation and service restoration sub-function generates list of recommended switching orders	A list of recommended switching orders using remotely controlled switches is presented to the Regional System Operator.	FLIR function	Regional System Operator	List of switching orders recommended after fault detection		User Interface

#	Event	Primary Actor	Name of Process/Activity	Description of Process/Activity	Information Producer	Information Receiver	Name of Info Exchanged	Additional Notes	IECSA Environments
2.3.13b		FLIR function	Fault isolation and service restoration sub-function generates list of recommended switching orders	In advisory mode, Regional System Operator considers the list of switching order alternatives and selects the best SO based on predefined criteria	FLIR function	Regional System Operator	List of switching orders recommended after fault detection		User Interface
2.3.14a		Regional System Operator, DMS SCADA database	SO execution	In the advisory mode, the Regional System Operator, after reviewing SO, issues supervisory commands to execute it.	Regional System Operator	DMS SCADA database	Supervisory command to execute SO issued after fault detection		User Interface
2.3.14b		FLIR, DMS SCADA database	SO execution	In the closed-loop mode, FLIR issues command to execute the best SO.	FLIR	DMS SCADA database	Supervisory command to execute SO issued after fault detection		Intra-Control Center

#	Event	Primary Actor	Name of Process/Activity	Description of Process/Activity	Information Producer	Information Receiver	Name of Info Exchanged	Additional Notes	IECSA Environments
2.3.15		Regional System Operator, field crew	Regional System Operator informs field crew	Regional System Operator authorizes to patrol the faulted section to accurately locate the fault and perform binary search if needed.	Regional System Operator	Field Personnel	Authorization to patrol faulted line		User Interface
2.3.16		Field Personnel, Regional System Operator	Field Personnel informs Regional System Operator	After accurately locating the fault, the crew informs the Regional System Operator about the status of switches involved in additional switching to isolate the smallest possible faulted section.	Field Personnel	Regional System Operator	Status of switches involved in isolating the smallest possible faulted section		User Interface
2.3.17, 2.3.18		Regional System Operator, ADADatabase	Entering status of switches and faulted section into Advanced Distribution Automation System database	The Regional System Operator enters status of switches (pseudo-statuses) involved in final fault isolation and the faulted section into Advanced Distribution Automation System database.	Regional System Operator	ADADatabase	Advanced Distribution Automation System database update additional fault isolation		User Interface

#	Event	Primary Actor	Name of Process/Activity	Description of Process/Activity	Information Producer	Information Receiver	Name of Info Exchanged	Additional Notes	IECSA Environments
2.3.19		Regional System Operator, FLIR	Entering status of switches and faulted section into Advanced Distribution Automation System database	Entering the faulted section into Advanced Distribution Automation System database initiates FLIR for generating final SO	ADADatabase	FLIR	Fault isolation and service restoration sub-function initiation after additional fault isolation		Intra-Control Center
2.3.20		ADADatabase, FLIR function	Fault isolation and service restoration sub-function generates list of recommended switching orders	Fault isolation and service restoration sub-function receives Advanced Distribution Automation System database excerpts updated after additional fault isolation.	ADADatabase	FLIR function	Advanced Distribution Automation System database excerpts		Intra-Control Center

#	Event	Primary Actor	Name of Process/Activity	Description of Process/Activity	Information Producer	Information Receiver	Name of Info Exchanged	Additional Notes	IECSA Environments
2.3.21		FLIR function, ADAHistoricDatabase	Fault isolation and service restoration sub-function generates list of recommended switching orders	FLIR issues a report for archiving in AdvancedDistributionAutomationSystem historic database.	FLIR function	ADAHistoric Database	Report including interrupted, unserved and restored load, and number of customers after additional fault isolation		Intra-Control Center
2.3.22a		FLIR function, Regional System Operator	Fault isolation and service restoration sub-function generates list of recommended switching orders	A list of recommended final switching orders is presented to the Regional System Operator.	FLIR function	Regional System Operator	List of switching orders recommended after additional fault isolation		User Interface
2.3.23a		Regional System Operator, DMS SCADA database	SO execution	In the advisory mode, the Regional System Operator, after reviewing SO, issues supervisory commands to execute it.	Regional System Operator	DMS SCADA database	Supervisory command to execute SO issued after additional fault isolation		User Interface

#	Event	Primary Actor	Name of Process/Activity	Description of Process/Activity	Information Producer	Information Receiver	Name of Info Exchanged	Additional Notes	IECSA Environments
2.3.23b		FLIR, DMS SCADA database	SO execution	In the closed-loop mode, FLIR issues commands to execute SO.	FLIR	DMS SCADA database	Supervisory command to execute SO issued after additional fault isolation		Intra-Control Center

2.2.2.4 FLIR Fault with Remotely-Controlled and Manual Switches and Distributed Intelligence System (DIS)

#	Event	Primary Actor	Name of Process/Activity	Description of Process/Activity	Information Producer	Information Receiver	Name of Info Exchanged	Additional Notes	IECSA Environments
#	<i>Triggering event? Identify the name of the event.¹⁰</i>	<i>What other actors are primarily responsible for the Process/Activity? Actors are defined in section 1.5.</i>	<i>Label that would appear in a process diagram. Use action verbs when naming activity.</i>	<i>Describe the actions that take place in active and present tense. The step should be a descriptive noun/verb phrase that portrays an outline summary of the step. "If ...Then...Else" scenarios can be captured as multiple Actions or as separate steps.</i>	<i>What other actors are primarily responsible for Producing the information? Actors are defined in section 1.5.</i>	<i>What other actors are primarily responsible for Receiving the information? Actors are defined in section 1.5. (Note – May leave blank if same as Primary Actor)</i>	<i>Name of the information object. Information objects are defined in section 1.6</i>	<i>Elaborate architectural issues using attached spreadsheet. Use this column to elaborate details that aren't captured in the spreadsheet.</i>	<i>Reference the applicable IECSA Environment containing this data exchange. Only one environment per step.</i>

¹⁰ Note – A triggering event is not necessary if the completion of the prior step – leads to the transition of the following step.

#	Event	Primary Actor	Name of Process/Activity	Description of Process/Activity	Information Producer	Information Receiver	Name of Info Exchanged	Additional Notes	IECSA Environments
2.4.1a	Fault with remotely-controlled and manual switches and with DIS	IEDs of DIS members, Distributed Intelligence Schemes	DIS identifies relevant protective device, de-energized sections and probable fault location and finds service restoration solution	Distributed Intelligence System (DIS) receives the real-time local status and analog data.	IEDs of DIS members	Distributed Intelligence Schemes	Real-time local status and analog data		Intra-Control Center
2.4.2a		Distributed Intelligence Schemes, IEDs of DIS members	DIS identifies relevant protective device, de-energized sections and probable fault location and finds service restoration solution	DIS communicates to DIS members the switching instructions for fault isolation and service restoration.	Distributed Intelligence Schemes	IEDS of DIS members	Command to isolate fault and restore service to healthy sections.		Intra-Control Center

#	Event	Primary Actor	Name of Process/Activity	Description of Process/Activity	Information Producer	Information Receiver	Name of Info Exchanged	Additional Notes	IECSA Environments
2.4.3a		Distributed Intelligence Schemes, DMS SCADA database	DIS identifies relevant protective device, de-energized sections and probable fault location and finds service restoration solution	Changes in connectivity implemented by DIS are downloaded into DMS SCADA database.	Distributed Intelligence Schemes	DMS SCADA database	Changes in connectivity implemented by DIS		Intra-Control Center
2.4.4a		DMS SCADA database, DOMA function	Checking real-time data	DOMA function receives the scan of DMS SCADA data to be checked for changes in topology. It also receives the latest relevant analog data.	DMS SCADA database	DOMA function	DMS real-time analog, status & TLQ data, phasor data from WAMACS		Intra-Control Center
2.4.5a		DOMA function, topology update function	Checking real-time data	ADATopologyUpdateSystem receives the changes in connectivity implemented by DIS	DOMA function	ADATopologyUpdateSystem	Changes in connectivity implemented by DIS		Intra-Control Center
2.4.6a		ADATopologyUpdateSystem, ADADatabase	ADATopologyUpdateSystem changes connectivity	AdvancedDistributionAutomationSystem database is updated with changes in connectivity implemented by DIS	ADATopologyUpdateSystem	ADADatabase	Changes in connectivity implemented by DIS		Intra-Control Center

#	Event	Primary Actor	Name of Process/Activity	Description of Process/Activity	Information Producer	Information Receiver	Name of Info Exchanged	Additional Notes	IECSA Environments
2.4.1b		IEDs of DIS members, Distributed Intelligence Schemes	DIS identifies relevant protective device, de-energized sections and probable fault location and can not find service restoration solution	Distributed Intelligence System (DIS) receives real-time local status and analog data.	IEDs of DIS members	Distributed Intelligence Schemes	Real-time status and analog data		Intra-Control Center
2.4.2b		Distributed Intelligence Schemes, DMS SCADA database	DIS identifies relevant protective device, de-energized sections and probable fault location and can not find service restoration solution	Indication of DIS inability to find a solution is downloaded into DMS SCADA database.	Distributed Intelligence Schemes	DMS SCADA database	Indication of DIS inability to find a solution		Intra-Control Center

#	Event	Primary Actor	Name of Process/Activity	Description of Process/Activity	Information Producer	Information Receiver	Name of Info Exchanged	Additional Notes	IECSA Environments
2.4.3b		DMS SCADA database, DOMA function	Checking real-time data	Due to DIS inability to find a solution, AdvancedDistributionAutomationSystem is initiated.	DMS SCADA database	DOMA function	Command to initiate AdvancedDistributionAutomationSystem, DMS real-time analog, status & TLQ data		Intra-Control Center
2.4.4b		OutageManagementSystem, DOMA function	Checking real-time data	DOMA function receives the scan of latest schedules of presently active or authorized for future outages to be checked for changes.	OutageManagementSystem	DOMA function	Schedules of presently active or authorized for future outages		Intra-Control Center
2.4.5b		EnergyManagementSystem SCADA database, DOMA function	Checking real-time data	DOMA function receives the scan of EnergyManagementSystem SCADA data to be checked for relevant changes or events.	EnergyManagementSystem SCADA database	DOMA function	EnergyManagementSystem real-time analog, status, TLQ data		Intra-Control Center
2.4.6b		Environmental daily data collector, DOMA function	Checking real-time data	DOMA function receives the scan of environmental data to be checked for changes affecting DER schedule forecast.	Environmental daily data collector	DOMA function	Real-time environmental data for DER schedule forecast		Intra-Control Center

#	Event	Primary Actor	Name of Process/Activity	Description of Process/Activity	Information Producer	Information Receiver	Name of Info Exchanged	Additional Notes	IECSA Environments
2.4.7b		Fault location function, DOMA function	Checking real-time data	DOMA function receives the distance to fault location, which is provided by fault-locating relay in the presence of the fault.	Fault location function	DOMA function	Distance to fault location		Intra-Control Center
2.4.8b		DOMA function, ADATopologyUpdateSystem	ADATopologyUpdateSystem changes connectivity	After DOMA detects fault in distribution, relevant information is provided to topology function.	DOMA function	ADATopologyUpdateSystem	Circuit breaker lockouts, inputs from OutageManagementSystem		Intra-Control Center
2.4.9b		ADATopologyUpdateSystem, ADADatabase	ADATopologyUpdateSystem changes connectivity	After fault is detected, AdvancedDistributionAutomationSystem database is updated.	ADATopologyUpdateSystem	ADADatabase	Update of AdvancedDistributionAutomationSystem database		Intra-Control Center
2.4.10b		ADATopologyUpdateSystem, FLIR function	Fault location subfunction identifies fault-related protective devices and de-energized sections	Topology function initiates fault location sub-function of the FLIR function.	ADATopologyUpdateSystem	FLIR function	Fault location subfunction initiation		Intra-Control Center

#	Event	Primary Actor	Name of Process/Activity	Description of Process/Activity	Information Producer	Information Receiver	Name of Info Exchanged	Additional Notes	IECSA Environments
2.4.11b		ADADatabase, FLIR function	Fault location subfunction identifies fault-related protective devices and de-energized sections	Fault location subfunction receives the needed data from AdvancedDistributionAutomationSystem database after it was updated with fault information.	ADADatabase	FLIR function	Excerpts from AdvancedDistributionAutomationSystem database updated after fault detection		Intra-Control Center
2.4.12b		FLIR function	Fault isolation and service restoration sub-function generates list of recommended switching orders	Fault location subfunction initiates fault isolation and service restoration sub-function of the FLIR function.	Fault location function	Fault isolation and service restoration subfunction	Fault isolation and service restoration sub-function initiation, probable fault location with alternatives		Intra-Control Center

#	Event	Primary Actor	Name of Process/Activity	Description of Process/Activity	Information Producer	Information Receiver	Name of Info Exchanged	Additional Notes	IECSA Environments
2.4.13b		ADADatabase, FLIR function	Fault isolation and service restoration sub-function generates list of recommended switching orders	Fault isolation and service restoration sub-function receives AdvancedDistributionAutomationSystem database excerpts updated with fault information.	ADADatabase	FLIR function	AdvancedDistributionAutomationSystem database excerpts		Intra-Control Center
2.4.14b		FLIR function, ADAHistoricDatabase	Fault isolation and service restoration sub-function generates list of recommended switching orders	FLIR issues a report for archiving in AdvancedDistributionAutomationSystem historic database.	FLIR function	ADAHistoric Database	Report including interrupted, unserved and restored load, and number of customers before additional fault isolation		Intra-Control Center

#	Event	Primary Actor	Name of Process/Activity	Description of Process/Activity	Information Producer	Information Receiver	Name of Info Exchanged	Additional Notes	IECSA Environments
2.4.15b		FLIR function, Regional System Operator	Fault isolation and service restoration sub-function generates list of recommended switching orders	A list of recommended switching orders is presented to the Regional System Operator.	FLIR function	Regional System Operator	List of switching orders recommended after fault detection		User Interface
2.4.16b		Regional System Operator, DMS SCADA database	SO execution	In the advisory mode, the Regional System Operator, after reviewing SO, issues a supervisory command to execute it.	Regional System Operator	DMS SCADA database	Supervisory command to execute SO issued after fault detection		User Interface
2.4.17b		Regional System Operator, field crew	Regional System Operator informs field crew	Regional System Operator authorizes to patrol the faulted line to accurately locate fault.	Regional System Operator	Field Personnel	Authorization to patrol faulted line		User Interface

#	Event	Primary Actor	Name of Process/Activity	Description of Process/Activity	Information Producer	Information Receiver	Name of Info Exchanged	Additional Notes	IECSA Environments
2.4.18b		Field Personnel, Regional System Operator	Field Personnel informs Regional System Operator	After locating the fault, the crew informs the Regional System Operator about the status of switches involved in additional switching to isolate the smallest possible faulted section.	Field Personnel	Regional System Operator	Status of switches involved in isolating the smallest possible faulted section		User Interface
2.4.19b, 2.4.20b		Regional System Operator, ADA Database	Entering status of switches and faulted section into Advanced Distribution Automation System database	The Regional System Operator enters status of switches (pseudo-statuses) involved in final fault isolation and the faulted section into Advanced Distribution Automation System database.	Regional System Operator	ADA Database	Advanced Distribution Automation System database update additional fault isolation		User Interface
2.4.21b		Regional System Operator, FLIR	Entering status of switches and faulted section into Advanced Distribution Automation System database	Entering the faulted section into Advanced Distribution Automation System database initiates FLIR	ADA Database	FLIR	Fault isolation and service restoration sub-function initiation after additional fault isolation		Intra-Control Center

#	Event	Primary Actor	Name of Process/Activity	Description of Process/Activity	Information Producer	Information Receiver	Name of Info Exchanged	Additional Notes	IECSA Environments
2.4.22b		ADADatabase, FLIR function	Fault isolation and service restoration sub-function generates list of recommended switching orders	Fault isolation and service restoration sub-function receives AdvancedDistributionAutomationSystem database excerpts updated after additional fault isolation.	ADADatabase	FLIR function	AdvancedDistributionAutomationSystem database excerpts		Intra-Control Center
2.4.23b		FLIR function, ADAHistoricDatabase	Fault isolation and service restoration sub-function generates list of recommended switching orders	FLIR issues a report for archiving in AdvancedDistributionAutomationSystem historic database.	FLIR function	ADAHistoric Database	Report including interrupted, unserved and restored load, and number of customers after additional fault isolation		Intra-Control Center

#	Event	Primary Actor	Name of Process/Activity	Description of Process/Activity	Information Producer	Information Receiver	Name of Info Exchanged	Additional Notes	IECSA Environments
2.4.24b		FLIR function, Regional System Operator	Fault isolation and service restoration sub-function generates list of recommended switching orders	A list of recommended switching orders is presented to the Regional System Operator.	FLIR function	Regional System Operator	List of switching orders recommended after additional fault isolation		User Interface
2.4.25b		Regional System Operator, DMS SCADA database	SO execution	The Regional System Operator, after reviewing SO, issues a supervisory command to execute it, if remotely controlled switches are used. If manual switches are involved, the Regional System Operator dispatches the crew to implement the switching order.	Regional System Operator	DMS SCADA database	Supervisory command to execute SO issued after additional fault isolation; instructions for the crew.		User Interface

2.2.2.5 FLIR Fault with DER Connected to Healthy Section

#	Event	Primary Actor	Name of Process/Activity	Description of Process/Activity	Information Producer	Information Receiver	Name of Info Exchanged	Additional Notes	IECSA Environments
#	<i>Triggering event? Identify the name of the event.¹¹</i>	<i>What other actors are primarily responsible for the Process/Activity? Actors are defined in section 1.5.</i>	<i>Label that would appear in a process diagram. Use action verbs when naming activity.</i>	<i>Describe the actions that take place in active and present tense. The step should be a descriptive noun/verb phrase that portrays an outline summary of the step. "If ...Then...Else" scenarios can be captured as multiple Actions or as separate steps.</i>	<i>What other actors are primarily responsible for Producing the information? Actors are defined in section 1.5.</i>	<i>What other actors are primarily responsible for Receiving the information? Actors are defined in section 1.5. (Note – May leave blank if same as Primary Actor)</i>	<i>Name of the information object. Information objects are defined in section 1.6</i>	<i>Elaborate architectural issues using attached spreadsheet. Use this column to elaborate details that aren't captured in the spreadsheet.</i>	<i>Reference the applicable IECSA Environment containing this data exchange. Only one environment per step.</i>
2.5.1	Fault in a circuit with DER connected to healthy section cleared by fast circuit breaker trip and by reverse protection from DER fault injection creating a self-sufficient island	DMS SCADA database, relay protection schemes, historic database	Unintentional self-sufficient island is created	DOMA receives the scan of DMS SCADA data and historic load data to be checked for changes in topology and loading during the time of repair.	DMS SCADA database	DOMA	DMS real-time analog, status & TLQ data, phasor data from WAMACS		Intra-Control Center

¹¹ Note – A triggering event is not necessary if the completion of the prior step – leads to the transition of the following step.

#	Event	Primary Actor	Name of Process/Activity	Description of Process/Activity	Information Producer	Information Receiver	Name of Info Exchanged	Additional Notes	IECSA Environments
2.5.2a		DOMA	Checking the sufficiency of the island during the time of repair	DOMA determines the sufficiency of the island during the time of repair and enables FLIR for location of the fault within the de-energized section.	DOMA	FLIR	Instructions to FLIR		Intra-Control Center
2.5.2b		DOMA	Checking the sufficiency of the island during the time of repair	DOMA determines the insufficiency of the island during the portion of time of repair and enables FLIR for location of the fault within the de-energized section and solving restoration for the customers connected to the island.	DOMA	FLIR	Instructions to FLIR		Intra-Control Center

#	Event	Primary Actor	Name of Process/Activity	Description of Process/Activity	Information Producer	Information Receiver	Name of Info Exchanged	Additional Notes	IECSA Environments
2.5.3	Fault in a circuit with DER connected to healthy section cleared by fast circuit breaker trip and by reverse protection from DER fault injection, creating an insufficient island	DMS SCADA database, relay protection schemes, historic database	Unintentional insufficient island is created, DER is separated with or without balanced load	DOMA receives the scan of DMS SCADA data and historic load data to be checked for changes in topology and loading during the time of repair.	DMS SCADA database	DOMA	DMS real-time analog, status & TLQ data, phasor data from WAMACS		Intra-Control Center
2.5.4		DOMA	Checking the sufficiency of the island during the time of repair	DOMA determines the insufficiency of the island during the time of repair and enables FLIR for location of the fault within the de-energized section and solving restoration for the de-energized customers connected to the island.	DOMA	FLIR	Instructions to FLIR		Intra-Control Center

#	Event	Primary Actor	Name of Process/Activity	Description of Process/Activity	Information Producer	Information Receiver	Name of Info Exchanged	Additional Notes	IECSA Environments
2.5.5	Fault in a circuit with DER connected to healthy section cleared by circuit breaker and by relay protection of DER at the PCC	DMS SCADA database, relay protection schemes, historic database	The feeder is de-energized, DER is separated with or without balanced load	DOMA receives the scan of DMS SCADA data and historic load data to be checked for changes in topology and loading during the time of repair.	DMS SCADA database	DOMA	DMS real-time analog, status & TLQ data, phasor data from WAMACS		Intra-Control Center
2.5.6		DOMA	Checking the topology to ensure that DER is separated	DOMA determines the after-fault topology, the loading during the time of repair, and enables FLIR for location of the fault and solving isolation of the fault and restoration for the de-energized customers connected to the healthy portions of the feeder.	DOMA	FLIR	Instructions to FLIR		Intra-Control Center

2.3.1 Post-conditions and Significant Results

<i>Actor/Activity</i>	<i>Post-conditions Description and Results</i>
AdvancedDistributionAutomationSystem: Fault location function, Isolation and Restoration	Faulted section is identified. A solution for an optimal isolation of faulted portions of distribution feeder and restoration of services to healthy portions is provided to the operator; closed-loop execution of switching orders is available; outage time for the majority of customers is reduced to several minutes.

2.3.2 Diagrams

FLIR FIRST FAULT WITH ONLY MANUAL SWITCHES

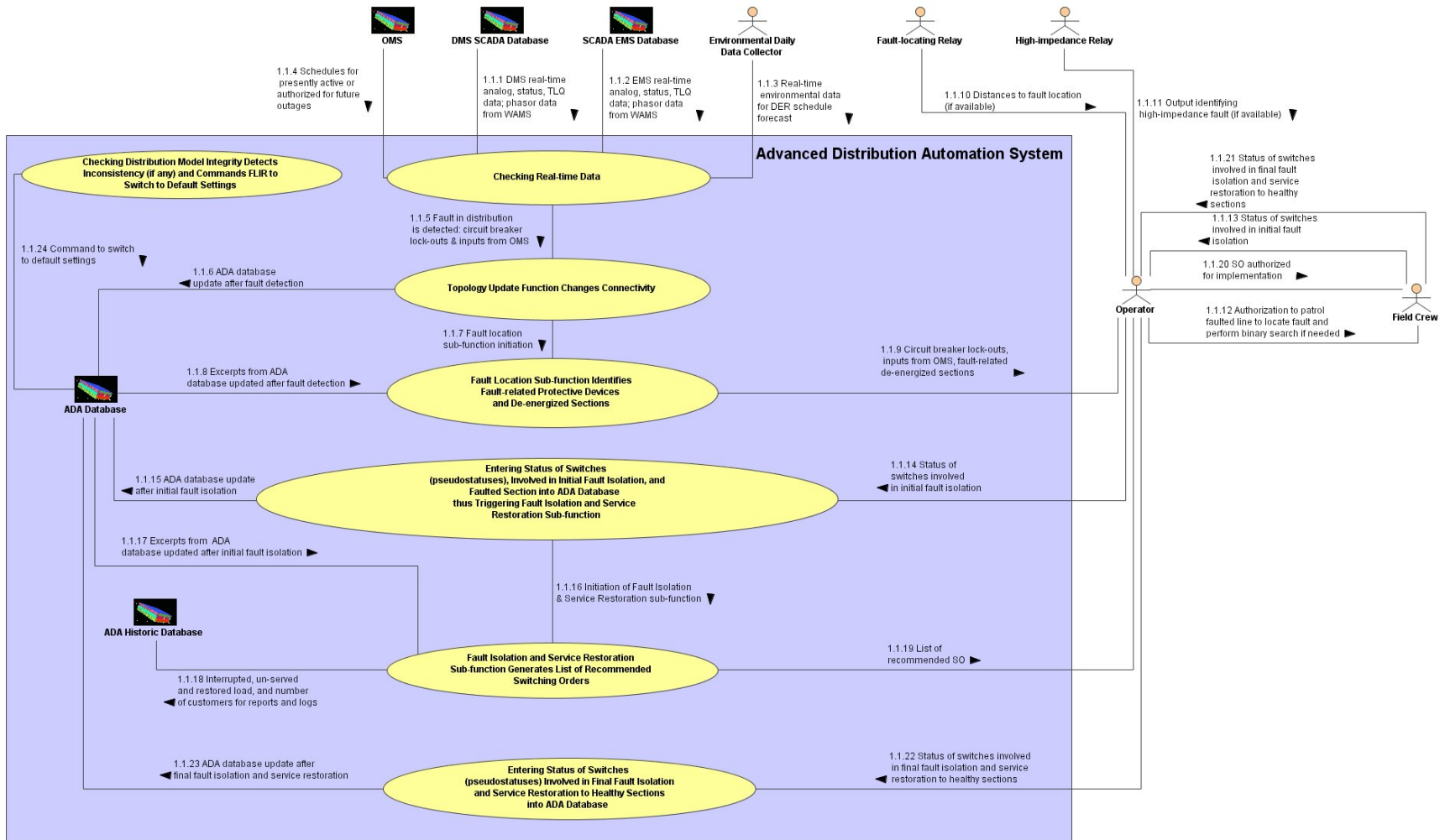

**FLIR SECOND FAULT
(RELATED TO FIRST FAULT WHICH IS NOT RESOLVED YET)
WITH ONLY MANUAL SWITCHES**

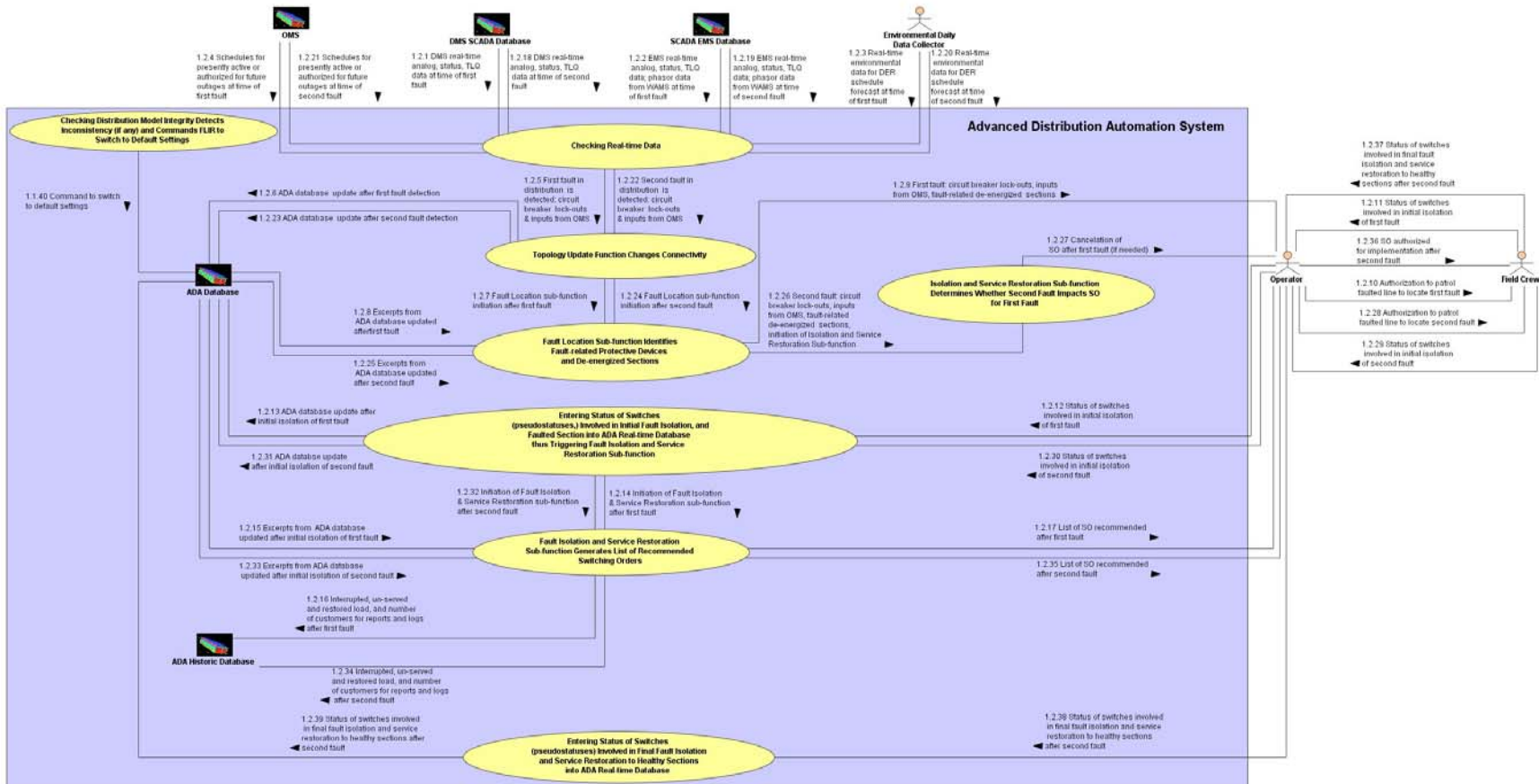

FLIR FAULT WITH REMOTELY-CONTROLLED AND MANUAL SWITCHES

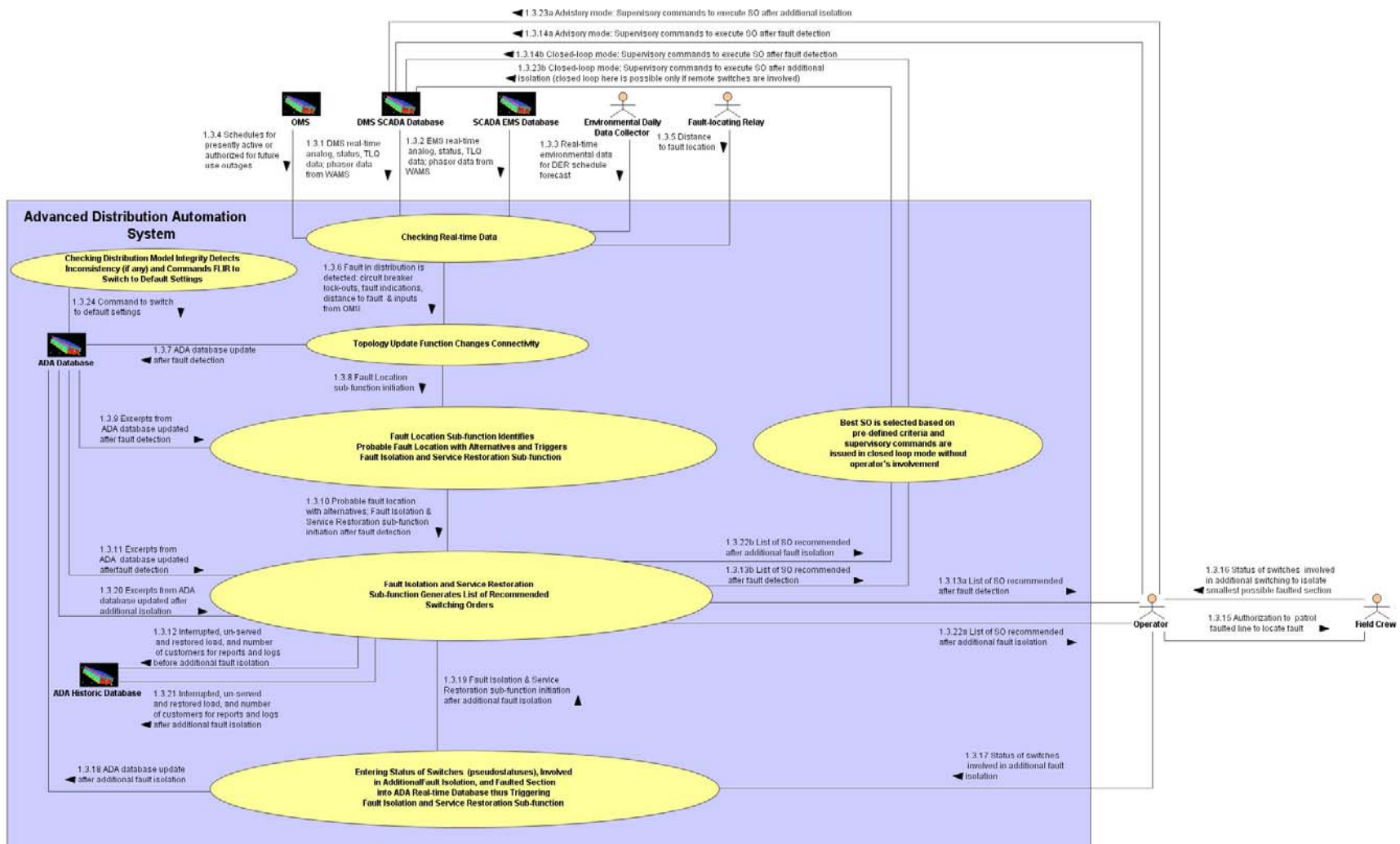

FLIR FAULT WITH REMOTELY-CONTROLLED AND MANUAL SWITCHES AND DISTRIBUTED INTELLIGENCE SYSTEM (DIS)

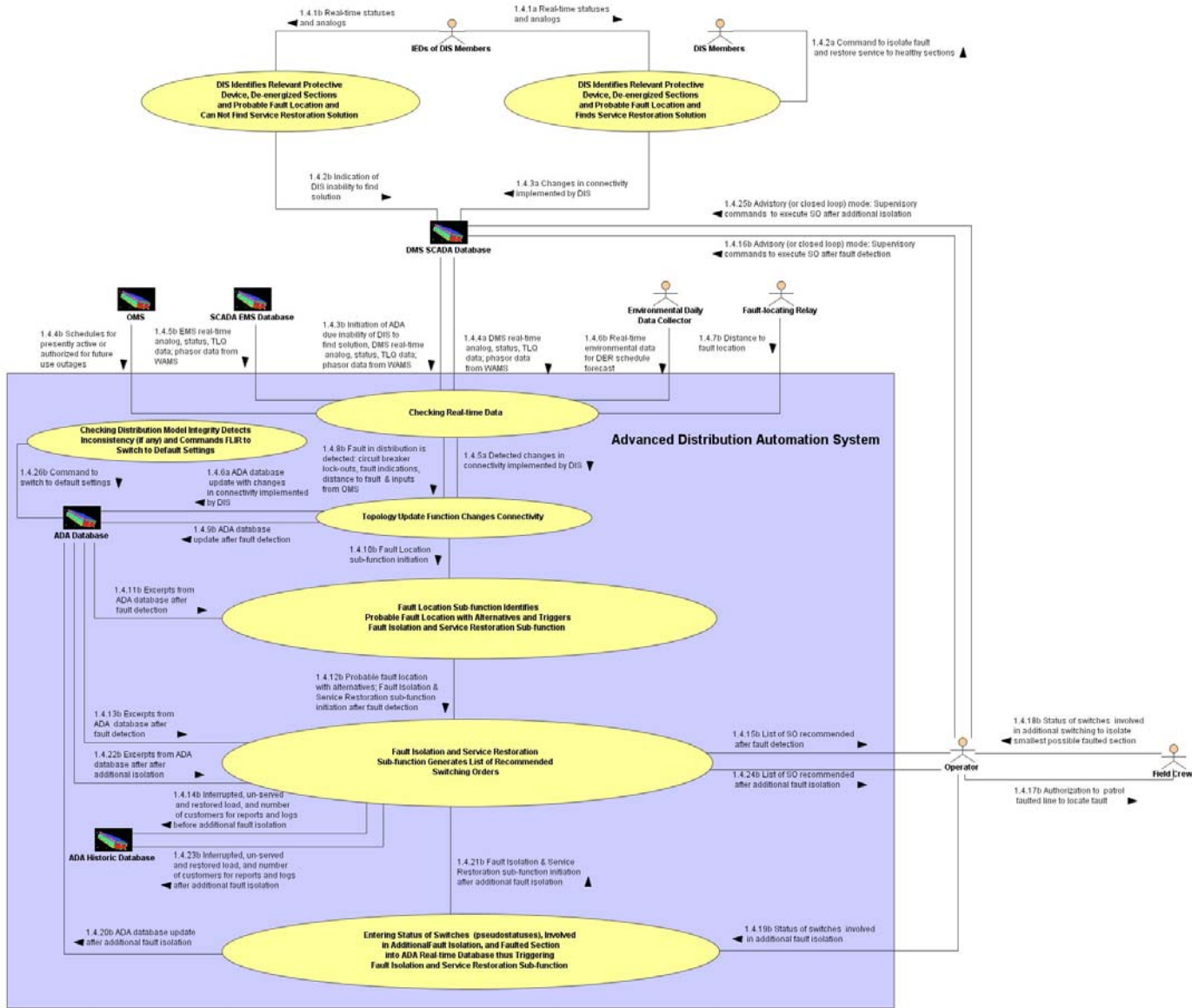

FLIR FAULT WITH DER CONNECTED TO HEALTHY SECTION

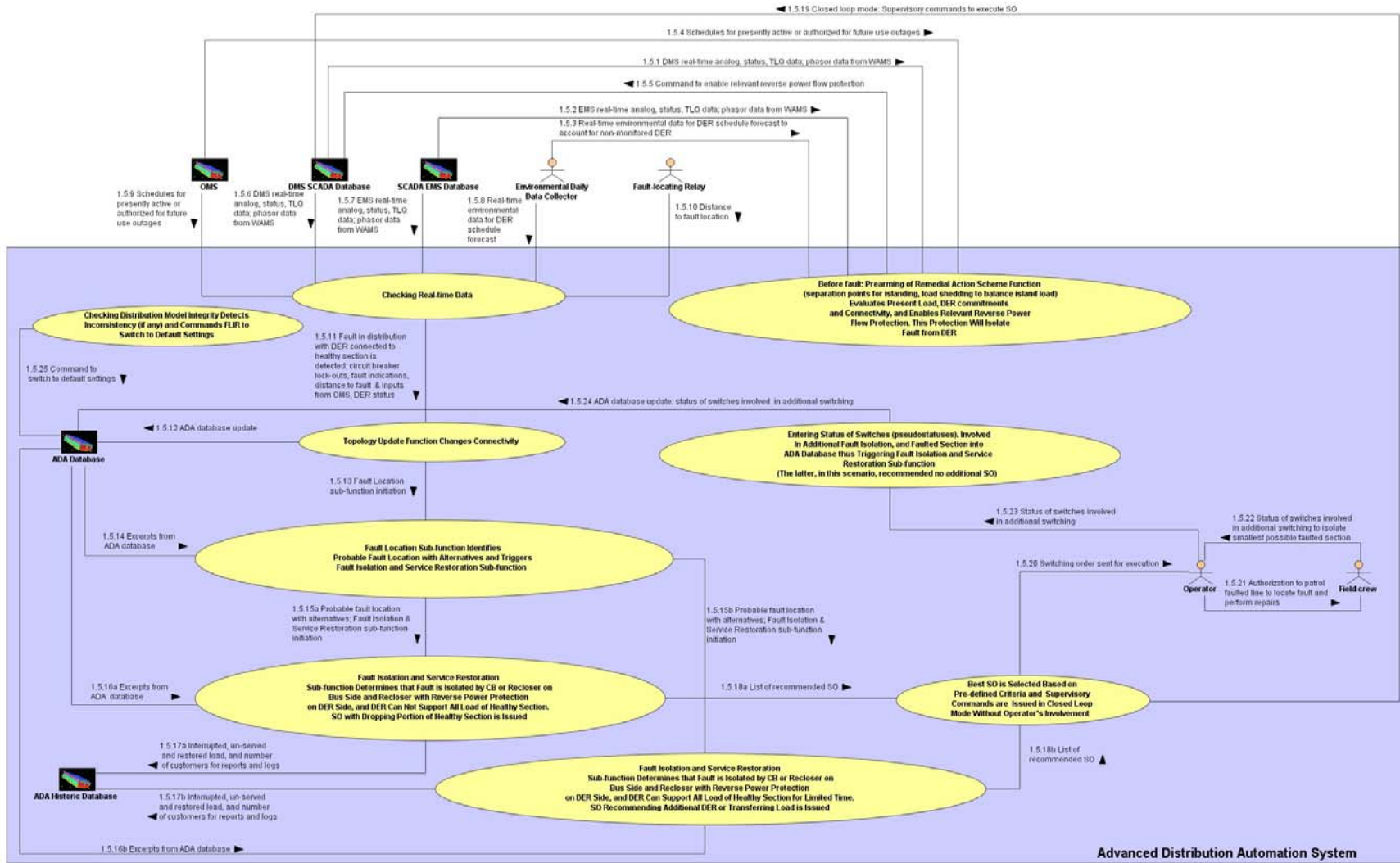

2.3 Volt/Var Control function (VVC)

2.3.1 VVC Preconditions and Assumptions

Describe conditions that must exist prior to the initiation of the Function, such as prior state of the actors and activities

Identify any assumptions, such as what systems already exist, what contractual relations exist, and what configurations of systems are probably in place

Identify any initial states of information exchanged in the steps in the next section. For example, if a purchase order is exchanged in an activity, its precondition to the activity might be 'filled in but unapproved'.

<i>Actor/System/Information/Contract</i>	<i>Preconditions or Assumptions</i>
EnergyManagementSystem SCADA	EnergyManagementSystem system contains the transmission power system model, and can provide the transmission connectivity information for facilities in the vicinity of the distribution power system facilities and with outputs from other EnergyManagementSystem applications
DMS SCADA database	DistributionSCADASystem database is updated via remote monitoring and operator inputs.. Required scope, speed, and accuracy of real-time measurements are provided, supervisory and closed-loop control is supported.
ADADistributionOperationModeling and Analysis (DOMA)	Preconditions: DistributionSCADASystem with several IEDs along distribution feeders, reporting statuses of remotely controlled switches and analogs including Amps, kW, kvar, and kV. Regional System Operator's ability for updating the SCADA database with statuses of switches not monitored remotely. Substation SCADA with analogs and statuses from CBs exists. EnergyManagementSystem is interfaced with AdvancedDistributionAutomationSystem. AdvancedDistributionAutomationSystem database is updated with the latest AM/FM and CIS data and operators input. The options for DOMA performance are selected
AdvancedDistributionAutomationSystem: Fault Location Isolation and Service Restoration (FLIR)	Fault Location Preconditions: DistributionSCADASystem with fault detectors, Distribution Operation Model and Analysis with fault analysis, fault location relays (schemes) including high impedance relays and Some Distributed Intelligence schemes and Trouble call system exist. Fault Isolation and Service Restoration Preconditions: DistributionSCADASystem with ability to control a defined number of switching devices, Fault Location, Distribution Operation Model and Analysis, Voltage and Var Control for adjusting voltage and var after reconfiguration. Supervisory and closed-loop control of switches are available. Some Distributed Intelligence schemes exist.
OutageManagementSystem	Outage Management System is interfaced with SCADA and AdvancedDistributionAutomationSystem and supports a dynamic topology model.
EnergyManagementSystem (WAMACS)	EnergyManagementSystem is interfaced with WAMACS and AdvancedDistributionAutomationSystem and provides phasor data for all distribution (reference) buses.
Regional System Operator	Regional System Operator has AdvancedDistributionAutomationSystem GUI and uses it for supervisory control of switches, for entering pseudo-SCADA statuses, selecting isolation and

<i>Actor/System/Information/Contract</i>	<i>Preconditions or Assumptions</i>
	restoration alternatives, etc. The operator also has the ability to communicate with the field crews via mobile communications and computing.
AdvancedDistributionAutomationSystem: Prearming of Remedial Action Schemes function	AdvancedDistributionAutomationSystem is interfaced with the RAS schemes with the capability of changing the priorities of RAS actions and settings.
ADAHistoricDatabase	Historic database is able to store large amount of data about outages, which will be used by the outage statistic application and other users.
AdvancedDistributionAutomationSystem: MFR function	Multi-feeder reconfiguration function with ability to optimally select feeder(s) connectivity for a given objective.

2.3.2 VVC Steps – Normal Sequence

Describe the normal sequence of events, focusing on steps that identify new types of information or new information exchanges or new interface issues to address. Should the sequence require detailed steps that are also used by other functions, consider creating a new “sub” function, then referring to that “subroutine” in this function. Remember that the focus should be less on the algorithms of the applications and more on the interactions and information flows between “entities”, e.g. people, systems, applications, data bases, etc. There should be a direct link between the narrative and these steps.

The numbering of the sequence steps conveys the order and concurrency and iteration of the steps occur. Using a Dewey Decimal scheme, each level of nested procedure call is separated by a dot ‘.’. Within a level, the sequence number comprises an optional letter and an integer number. The letter specifies a concurrent sequence within the next higher level; all letter sequences are concurrent with other letter sequences. The number specifies the sequencing of messages in a given letter sequence. The absence of a letter is treated as a default ‘main sequence’ in parallel with the lettered sequences.

Sequence 1:

- 1.1 - Do step 1
- 1.2A.1 - In parallel to activity 2 B do step 1
- 1.2A.2 - In parallel to activity 2 B do step 2
- 1.2B.1 - In parallel to activity 2 A do step 1
- 1.2B.2 - In parallel to activity 2 A do step 2
- 1.3 - Do step 3
- 1.3.1 - nested step 3.1
- 1.3.2 - nested step 3.2

Sequence 2:

- 2.1 - Do step 1
- 2.2 - Do step 2

2.3.2.1 VVC Function During Scheduled Run

#	Event	Primary Actor	Name of Process/Activity	Description of Process/Activity	Information Producer	Information Receiver	Name of Info Exchanged	Additional Notes	IECSA Environments
#	Triggering event? Identify the name of the event. ¹²	What other actors are primarily responsible for the Process/Activity? Actors are defined in section 1.5.	Label that would appear in a process diagram. Use action verbs when naming activity.	Describe the actions that take place in active and present tense. The step should be a descriptive noun/verb phrase that portrays an outline summary of the step. "If ...Then...Else" scenarios can be captured as multiple Actions or as separate steps.	What other actors are primarily responsible for Producing the information? Actors are defined in section 1.5.	What other actors are primarily responsible for Receiving the information? Actors are defined in section 1.5. (Note – May leave blank if same as Primary Actor)	Name of the information object. Information objects are defined in section 1.6	Elaborate architectural issues using attached spreadsheet. Use this column to elaborate details that aren't captured in the spreadsheet.	Reference the applicable IECSA Environment containing this data exchange. Only one environment per step.
3.1.1	Time for ADAVVC Controller scheduled run	DMS SCADA database, DOMA function	Checking real-time data	DOMA function receives the scan of DMS SCADA data to be checked for changes in topology. It also receives the latest relevant analog data.	DMS SCADA database	DOMA function	DMS real-time analog, status & TLQ data, status of voltage controllers, DER modes of operation, and settings		Intra-Control Center

¹² Note – A triggering event is not necessary if the completion of the prior step – leads to the transition of the following step.

#	Event	Primary Actor	Name of Process/Activity	Description of Process/Activity	Information Producer	Information Receiver	Name of Info Exchanged	Additional Notes	IECSA Environments
3.1.2		EnergyManagementSystem SCADA database, DOMA function	Checking real-time data	DOMA function receives the scan of EnergyManagementSystem SCADA data to be checked for relevant changes or events.	EnergyManagementSystem SCADA database	DOMA function	EnergyManagementSystem real-time analog, status, TLQ data		Intra-Control Center
3.1.3		DOMA function, ADAVVCController	VVC performs optimization according to current objective	The fact that no events and changes in connectivity are detected is communicated to ADAVVCController. ADAVVCController is triggered by the time schedule.	DOMA function	ADAVVCController	No events or changes in connectivity detected, command to start scheduled run		Intra-Control Center
3.1.4		ADADatabase, ADAVVCController	VVC performs optimization according to current objective	VVC receives the excerpts from AdvancedDistributionAutomationSystem database.	ADADatabase	ADAVVCController	Excerpts from AdvancedDistributionAutomationSystem database		Intra-Control Center
3.1.5		ADAVVCController, Regional System Operator	VVC performs optimization according to current objective	Relevant results of VVC optimization are displayed for the Regional System Operator.	ADAVVCController	Regional System Operator	VVC status, present and recommended bus kV, benefits, expected lowest and highest load voltage		User Interface

#	Event	Primary Actor	Name of Process/Activity	Description of Process/Activity	Information Producer	Information Receiver	Name of Info Exchanged	Additional Notes	IECSA Environments
3.1.6		ADAVVCController, DMS SCADA database	VVC performs optimization according to current objective	Relevant results of VVC optimization are sent to controllers in the field.	ADAVVCController	DMS SCADA database	Recommended settings to relevant voltage and power electronic controllers, DER modes of operation and settings, capacitor status		Intra-Control Center
3.1.7		ADAVVCController, ADAHistoricDatabase	VVC performs optimization according to current objective	Relevant results of VVC optimization are stored in AdvancedDistributionAutomationSystem historic database.	ADAVVCController	ADAHistoricDatabase	VVC and LTC states and settings; VVC limits and benefits; losses, voltage, objective function and total demand before and after optimization, logs		Intra-Control Center
3.1.8		DMS SCADA database, DOMA function	Checking real-time data	DOMA function receives the scan of DMS SCADA data to be checked for changes in topology and confirmation of execution of VVC commands. It also provides the latest relevant analog data.	DMS SCADA database	DOMA function	DMS real-time analog, status & TLQ data, status of voltage controllers, confirmation of execution of VVC commands		Intra-Control Center

#	Event	Primary Actor	Name of Process/Activity	Description of Process/Activity	Information Producer	Information Receiver	Name of Info Exchanged	Additional Notes	IECSA Environments
3.1.9		DMS SCADA database, ADAVVCCo ntroller	Information for Regional System Operator	Regional System Operator's display is regularly updated with data associated with LTC and VVC performance.	DMS SCADA database	ADAVVCCo ntroller	VVC: status, integrity, settings, limits, bandcenter, objective; LTC: status, position; bus voltage limits		Intra-Control Center

2.3.2.2 VVC Function During Event Run

#	Event	Primary Actor	Name of Process/Activity	Description of Process/Activity	Information Producer	Information Receiver	Name of Info Exchanged	Additional Notes	IECSA Environments
#	<i>Triggering event? Identify the name of the event.¹³</i>	<i>What other actors are primarily responsible for the Process/Activity? Actors are defined in section1.5.</i>	<i>Label that would appear in a process diagram. Use action verbs when naming activity.</i>	<i>Describe the actions that take place in active and present tense. The step should be a descriptive noun/verb phrase that portrays an outline summary of the step. "If ...Then...Else" scenarios can be captured as multiple Actions or as separate steps.</i>	<i>What other actors are primarily responsible for Producing the information? Actors are defined in section1.5.</i>	<i>What other actors are primarily responsible for Receiving the information? Actors are defined in section1.5. (Note – May leave blank if same as Primary Actor)</i>	<i>Name of the information object. Information objects are defined in section 1.6</i>	<i>Elaborate architectural issues using attached spreadsheet. Use this column to elaborate details that aren't captured in the spreadsheet.</i>	<i>Reference the applicable IECSA Environment containing this data exchange. Only one environment per step.</i>

¹³ Note – A triggering event is not necessary if the completion of the prior step – leads to the transition of the following step.

#	Event	Primary Actor	Name of Process/Activity	Description of Process/Activity	Information Producer	Information Receiver	Name of Info Exchanged	Additional Notes	IECSA Environments
3.2.1-1	ADAVVC Controller during event run	DOMA function	DOMA detects load voltage or overload violation	DOMA function detects load voltage or overload violation and initiates ADAVVCController.	DOMA function	ADAVVCCo ntroller	Command to initiate VVC		Intra-Control Center
3.2.1-11, 3.2.1-111, 3.2.1-1111		DMS SCADA database, DOMA function	Checking real-time data	DOMA function checks the real-time data for changes, alarms.	DMS SCADA database	DOMA function	DMS real-time analog, status, TLQ data, confirmation of execution of VVC commands, status of voltage controllers		Intra-Control Center
3.2.1-12, 3.2.1-112, 3.2.1-1112		SCADA EnergyManagementSystem database, DOMA function	Checking real-time data	DOMA function checks the real-time data for changes, alarms.	SCADA EnergyManagementSystem database	DOMA function	EnergyManagementSystem real-time analog, status, TLQ data		Intra-Control Center
3.2.1.13		DOMA function, ADAVVCController	Changing current objective to load reduction within normal limits due to high energy price	DOMA function detects high-energy price and issues command to change VVC objective.	DOMA function	ADAVVCCo ntroller	Command to change optimization objective		Intra-Control Center

#	Event	Primary Actor	Name of Process/Activity	Description of Process/Activity	Information Producer	Information Receiver	Name of Info Exchanged	Additional Notes	IECSA Environments
3.2.1.14		DOMA function, ADAVVCController	VVC performs optimization according to current objective	DOMA function issues command to initiate VVC.	DOMA function	ADAVVCController	Command to initiate VVC		Intra-Control Center
3.2.2		ADAVVCController, ADADatabase	VVC performs optimization according to current objective	ADAVVCController receives excerpt from AdvancedDistributionAutomationSystem database updated with latest SCADA scan.	ADADatabase	ADAVVCController	AdvancedDistributionAutomationSystem database excerpt		Intra-Control Center
3.2.3		ADAVVCController, Regional System Operator	VVC performs optimization according to current objective	VVC issues information relevant for Regional System Operator.	ADAVVCController	Regional System Operator	VVC status, present and recommended bus kV, benefits, expected lowest and highest load voltages		User Interface
3.2.4		ADAVVCController, DMS SCADA database	VVC performs optimization according to current objective	DMS SCADA database receives results of optimization.	ADAVVCController	DMS SCADA database	Recommended settings to relevant voltage and power electronic controllers, DER modes of operation and settings, capacitor status		Intra-Control Center

#	Event	Primary Actor	Name of Process/Activity	Description of Process/Activity	Information Producer	Information Receiver	Name of Info Exchanged	Additional Notes	IECSA Environments
3.2.5		ADAVVCController, ADAHistoricDatabase	VVC performs optimization according to current objective	Selected results are archived in ADAHistoricDatabase.	ADAVVCController	ADAHistoricDatabase	VVC and LTC states and settings; VVC limits and benefits; losses, voltage, objective function and total demand before and after optimization, logs		Intra-Control Center
3.2.6		ADAVVCController, DOMA function	VVC performs optimization according to current objective	ADAVVCController initiates DOMA function after confirmation of execution is received.	ADAVVCController	DOMA function	Command to initiate DOMA		Intra-Control Center
3.2.7		DOMA function, Regional System Operator	DOMA function performs analysis	DOMA function, after detecting a violation present during the after-optimization conditions, sends alarm to Regional System Operator.	DOMA function	Regional System Operator	Alarm for Regional System Operator		User Interface

#	Event	Primary Actor	Name of Process/Activity	Description of Process/Activity	Information Producer	Information Receiver	Name of Info Exchanged	Additional Notes	IECSA Environments
3.2.8		DOMA function, Remedial Action Scheme, Regional System Operator	Prearming RAS function adjusts settings of relevant groups of load shedding	DOMA function, after detecting that optimization has not eliminated transmission violation, sends an alarm to the Regional System Operator and triggers pre-arming of RAS.	DOMA function	Remedial Action Scheme, Regional System Operator	Information for prearming Remedial Action Scheme		User Interface
3.2.9		DMS SCADA database, Regional System Operator	Data for Regional System Operator	Relevant for Regional System Operator VVC and LTC settings, limits and statuses are displayed.	DMS SCADA database	Regional System Operator	VVC: status, integrity, settings, limits, bandcenter, objective LTC: status, position		User Interface
3.3.1		DOMA function, ADAVVCController	VVC determines violation can not be eliminated through optimization	DOMA function detects load voltage or voltage violation.	DOMA function	ADAVVCController	Command to initiate VVC		Intra-Control Center
3.3.2		ADADatabase, ADAVVCController	VVC determines violation can not be eliminated through optimization	VVC receives excerpts from AdvancedDistributionAutomationSystem database updated with latest SCADA scan.	ADADatabase	ADAVVCController	Excerpts from AdvancedDistributionAutomationSystem database		Intra-Control Center

#	Event	Primary Actor	Name of Process/Activity	Description of Process/Activity	Information Producer	Information Receiver	Name of Info Exchanged	Additional Notes	IECSA Environments
3.3.3		ADAVVCContr oller, MFR function	VVC determines violation can not be eliminated through optimization	VVC initiates MFR to eliminate the violation.	ADAVVCCon troller	MFR function	Command to initiate MFR		Intra-Control Center
3.3.4		ADAVVCContr oller, ADAHistoricDa tabase	VVC determines violation can not be eliminated through optimization	AdvancedDistributionA utomationSystem historic database receives logs issued by VVC.	ADAVVCCon troller	ADAHistoric Database	Logs		Intra-Control Center
3.4.1		DOMA function, ADAVVCContr oller	DOMA function detects distribution model inconsistency	After detecting distribution model inconsistency, DOMA function sets an inconsistency flag to put VVC in a default mode.	DOMA function	ADAVVCCo ntroller	Distribution model inconsistency flag		Intra-Control Center
3.4.2		ADAVVCContr oller, DMS SCADA database	VVC switches to default settings for portions of distribution system with inconsistent model	The fact that the VVC is switched to default setting has been issued is received by DMS SCADA database.	ADAVVCCon troller	DMS SCADA database	Fact that VVC is switched to default setting		Intra-Control Center

#	Event	Primary Actor	Name of Process/Activity	Description of Process/Activity	Information Producer	Information Receiver	Name of Info Exchanged	Additional Notes	IECSA Environments
3.4.3		ADAVVCController, AdvancedDistributionAutomationSystem historic database	VVC switches to default settings for portions of distribution system with inconsistent model	Log is stored in AdvancedDistributionAutomationSystem historic database.	ADAVVCController	ADAHistoric Database	Log		Intra-Control Center
3.5.1		DMS SCADA database, DOMA function	Checking real-time data	DOMA function checks the real-time data for changes, alarms.	DMS SCADA database	DOMA function	DMS real-time analog, status, TLQ data, confirmation of execution of VVC commands, status of voltage controllers		Intra-Control Center
3.5.2		SCADA EnergyManagementSystem database, DOMA function	Checking real-time data	DOMA function checks the real-time data for changes, alarms.	SCADA EnergyManagementSystem database	DOMA function	EnergyManagementSystem real-time analog, status, TLQ data		Intra-Control Center
3.5.3		DOMA function, ADAVVCController	VVC determines there is room for optimization and performs optimization within emergency limits	DOMA detects transmission emergency limit violation and issues a command to initiate VVC.	DOMA function	ADAVVCController	Command to initiate VVC		Intra-Control Center

#	Event	Primary Actor	Name of Process/Activity	Description of Process/Activity	Information Producer	Information Receiver	Name of Info Exchanged	Additional Notes	IECSA Environments
3.5.4		ADADatabase, ADAVVCCntr oller	VVC determines there is room for optimization and performs optimization within emergency limits	VVC receives excerpts from AdvancedDistributionA utomationSystem database updated with latest SCADA scan.	ADADatabase	ADAVVCCo ntroller	Excerpts from AdvancedDistrib utionAutomation System database		Intra-Control Center
3.5.5		ADAVVCCntr oller, Regional System Operator	VVC determines there is room for optimization and performs optimization within emergency limits	Selected optimization results are displayed for the Regional System Operator.	ADAVVCCon troller	Regional System Operator	VVC status, present and recommended bus kV, expected lowest and highest load V, flag of using emergency limits		User Interface
3.5.6		ADAVVCCntr oller, DMS SCADA database	VVC determines there is room for optimization and performs optimization within emergency limits	DMS SCADA database receives relevant optimization results.	ADAVVCCon troller	DMS SCADA database	Recommended settings to relevant voltage and power electronic controllers, DER modes of operation and settings, capacitors status		Intra-Control Center

#	Event	Primary Actor	Name of Process/Activity	Description of Process/Activity	Information Producer	Information Receiver	Name of Info Exchanged	Additional Notes	IECSA Environments
3.5.7		ADAVVCController, ADAHistoricDatabase	VVC determines there is room for optimization and performs optimization within emergency limits	Selected results are archived in AdvancedDistributionAutomationSystem historic database.	ADAVVCController	ADAHistoricDatabase	VVC and LTC states and settings; VVC limits and benefits; losses, voltage, objective function and total demand before and after optimization, logs		Intra-Control Center
3.5.8		ADAVVCController, DOMA function	VVC determines there is room for optimization and performs optimization within emergency limits	ADAVVCController initiates DOMA function after confirmation of execution is received.	ADAVVCController	DOMA function	Command to initiate DOMA		Intra-Control Center
3.5.9		DOMA function, Regional System Operator	DOMA function performs analysis	DOMA function, after detecting a violation present during the after-optimization conditions, sends alarm to Regional System Operator.	DOMA function	Regional System Operator	Alarm for Regional System Operator		User Interface

#	Event	Primary Actor	Name of Process/Activity	Description of Process/Activity	Information Producer	Information Receiver	Name of Info Exchanged	Additional Notes	IECSA Environments
3.5.10		DOMA function, Prearming of RAS schemes function	Prearming RAS adjusts settings of relevant groups of load shedding	DOMA function, after detecting that optimization has not eliminated transmission violation, sends an alarm to pre-arming RAS function.	DOMA function	Prearming of RAS schemes function	Alarm for prearming RAS function		Intra-Control Center
3.5.11		DMS SCADA database, Regional System Operator	Data for Regional System Operator	Relevant for Regional System Operator VVC and LTC settings, limits, and statuses are displayed.	DMS SCADA database	Regional System Operator	VVC: status, integrity, settings, limits, bandcenter, objective LTC: status, position		User Interface

2.3.2.3 VVC Function Participation in Severe Emergency in Bulk Power System with Intentional Islands

#	Event	Primary Actor	Name of Process/Activity	Description of Process/Activity	Information Producer	Information Receiver	Name of Info Exchanged	Additional Notes	IECSA Environments
#	<i>Triggering event? Identify the name of the event.¹⁴</i>	<i>What other actors are primarily responsible for the Process/Activity? Actors are defined in section 1.5.</i>	<i>Label that would appear in a process diagram. Use action verbs when naming activity.</i>	<i>Describe the actions that take place in active and present tense. The step should be a descriptive noun/verb phrase that portrays an outline summary of the step. "If ...Then...Else" scenarios can be captured as multiple Actions or as separate steps.</i>	<i>What other actors are primarily responsible for Producing the information? Actors are defined in section 1.5.</i>	<i>What other actors are primarily responsible for Receiving the information? Actors are defined in section 1.5. (Note – May leave blank if same as Primary Actor)</i>	<i>Name of the information object. Information objects are defined in section 1.6</i>	<i>Elaborate architectural issues using attached spreadsheet. Use this column to elaborate details that aren't captured in the spreadsheet.</i>	<i>Reference the applicable IECSA Environment containing this data exchange. Only one environment per step.</i>

¹⁴ Note – A triggering event is not necessary if the completion of the prior step – leads to the transition of the following step.

#	Event	Primary Actor	Name of Process/Activity	Description of Process/Activity	Information Producer	Information Receiver	Name of Info Exchanged	Additional Notes	IECSA Environments
3.6.1	The bulk power system is separated in near-balanced islands to prevent wide-area blackout. The load shedding schemes operated	Remedial Action Scheme, intentional islanding, Under-frequency load shedding (UFLS), Under-voltage load shedding, Special load shedding schemes	Creating transmission islands, and load-shedding by fast acting schemes	The conditions of capacity deficit are detected by EnergyManagement System/SCADA and submitted to VVC as a trigger for changing the objective and perform in emergency mode.	Transmission EnergyManagementSystem, Remedial Action Scheme.	AdvancedDistributionAutomationSystem load management functions	Command to initiate VVC in load reduction mode; commands from VVC to IEDs and DERs.		Intra-Control Center
3.6.2		SCADA EnergyManagementSystem database	Contingency in bulk power system creates transmission islands	SCADA EnergyManagement System receives status of switches (circuit breakers) in transmission affected by contingency.	Transmission EnergyManagementSystem, Remedial Action Scheme.	SCADA EnergyManagementSystem database	Status of switches		Intra-Control Center

#	Event	Primary Actor	Name of Process/Activity	Description of Process/Activity	Information Producer	Information Receiver	Name of Info Exchanged	Additional Notes	IECSA Environments
3.6.3		UFLS, DMS SCADA database	UFLS balances load and generation and changes distribution circuits connectivity	DMS SCADA database receives status of switches affected by load shedding.	FieldDevice	DMS SCADA database	Status of switches		Intra-Control Center
3.6.4		DMS SCADA database, DOMA function	Update of the topology and load models	DOMA function receives the latest scan of DMS SCADA database and adjusts the distribution operation model for VVC to perform in emergency load reduction mode. .	DMS SCADA database	DOMA function	DMS real-time analog, status, TLO data, status of voltage controllers.		Intra-Control Center
3.6.5		DOMA, ADAVVC Controller	Changing VVC current objective to load reduction within emergency limits	DOMA issues a command to change VVC objective and initiate optimization.	DOMA	ADAVVCCo ntroller	Command to change VVC objective and optimization		Intra-Control Center

#	Event	Primary Actor	Name of Process/Activity	Description of Process/Activity	Information Producer	Information Receiver	Name of Info Exchanged	Additional Notes	IECSA Environments
3.6.6		ADAVVC Controller	VVC performs optimization with emergency load reduction objective	VVC performs reduction of load not affected by load-shedding schemes to create capacity reserves and restore a portion of shed loads.	ADAVVCCon troller	DMS SCADA database	Settings for voltage controllers, statuses of capacitors, power electronics statuses of DER, modes of operation and settings of DER controllers.		Intra-Control Center

2.3.3 Post-conditions and Significant Results

Describe conditions that must exist at the conclusion of the Function. Identify significant items similar to that in the preconditions section.

Describe any significant results from the Function

<i>Actor/Activity</i>	<i>Post-conditions Description and Results</i>
AdvancedDistributionAutomationSystem: Volt-var Control	Optimal voltage controller settings, capacitor statuses and DER modes of operation and settings, for a given objective(s) are sent to respective controllers. The power quality is enhanced. The distribution facilities are better utilized; the transmission and generation systems are better supported by volt and vars; the load management is less intrusive; the customers pay smaller bills.

2.3.4 Diagrams

VOLT/VAR OPTIMIZATION FUNCTION IN CLOSED-LOOP MODE DURING SCHEDULED RUN

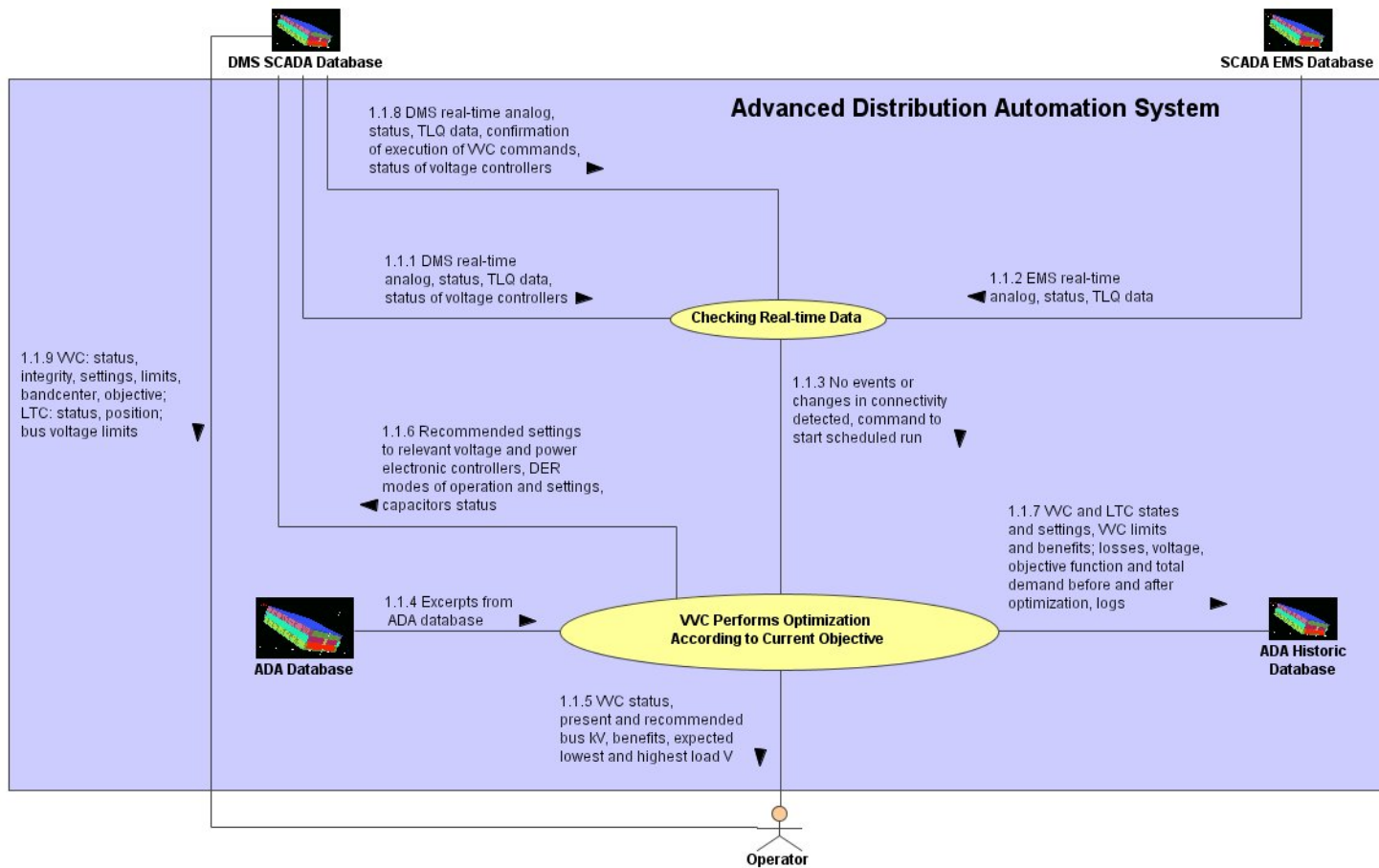

VOLT/VAR OPTIMIZATION FUNCTION IN CLOSED-LOOP MODE DURING EVENT RUN

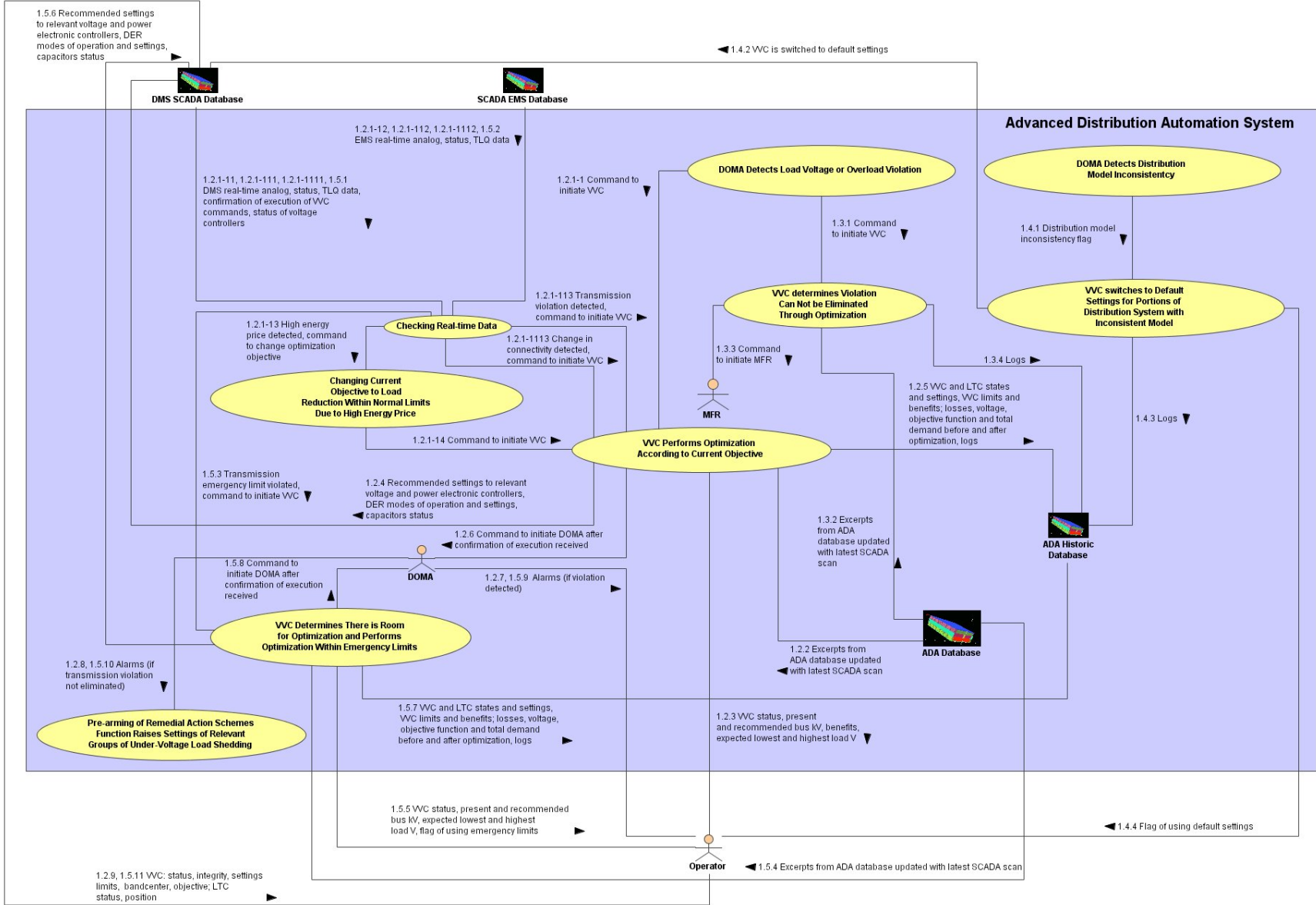

VVC PARTICIPATION IN SEVERE EMERGENCY IN BULK POWER SYSTEM WITH INTENTIONAL ISLANDS

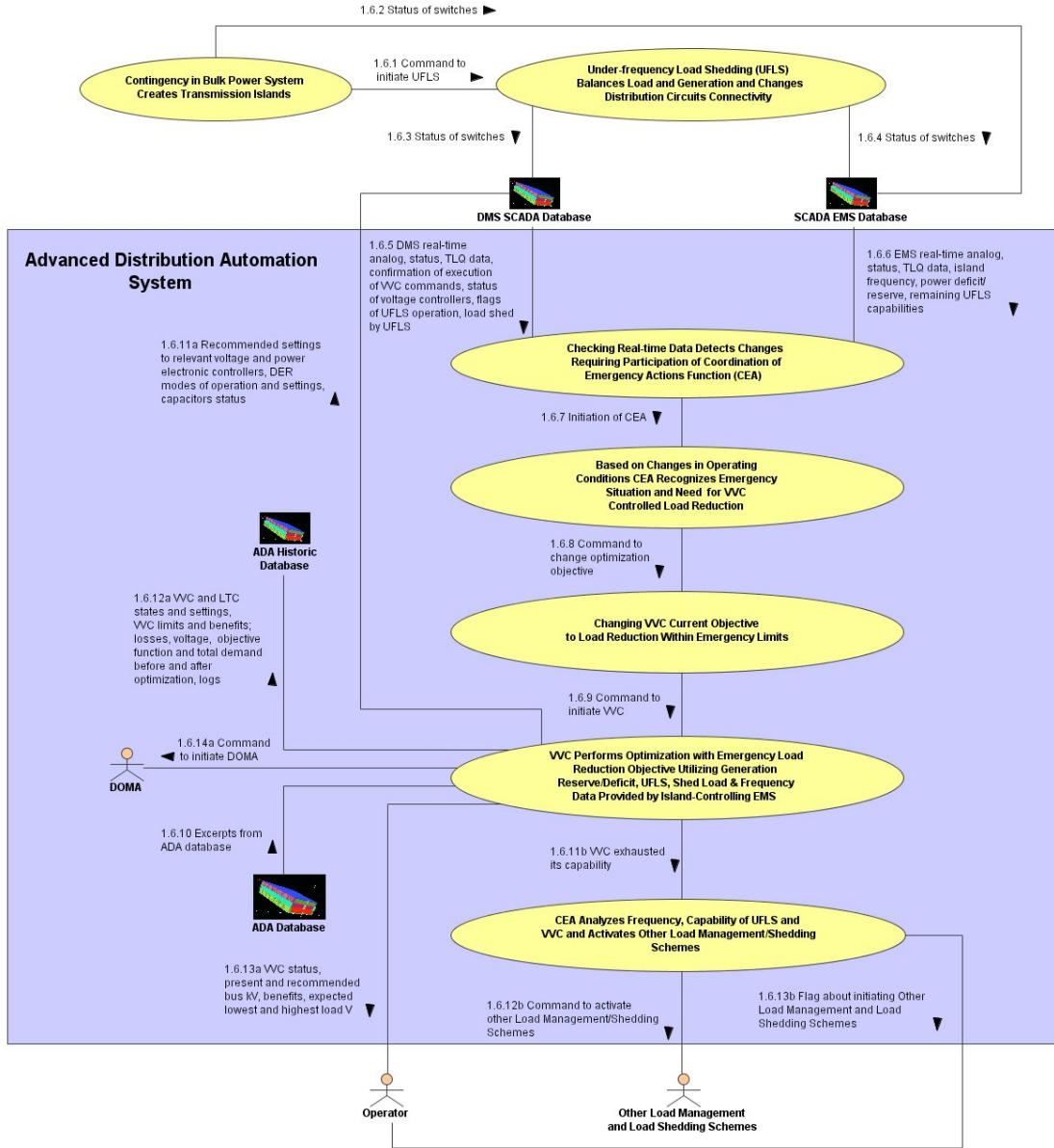

2.4 Architectural Issues in Interactions

Elaborate on all architectural issues in each of the steps outlined in each of the sequences above. Reference the Step by number..

2.5 Current Implementation Status

Describe briefly the current implementation status of the function and/or parts of it, referring to Steps above
Identify the key existing products, standards and technologies

<i>Product/Standard/Technology</i> Eg. DNP 3	<i>Ref - Usage</i> 2.1.2.1[1] - Exchange of SCADA information

Current Implementations:

<i>Relative maturity of function across industry:</i>	<i>Ref - Status Discussion</i>
Very mature and widely implemented	Discussion
Moderately mature	
Fairly new	
Future, no systems, no interactions	

<i>Existence of legacy systems involved in function:</i>	<i>Ref - Status Discussion</i>
Many legacy systems	
Some legacy systems	
Few legacy systems	
No legacy systems	
Extensive changes will be needed for full functionality	
Moderate changes will be needed	
Few changes will be needed	

No changes will be needed

Implementation Concerns

Ref - Status Discussion

Data availability and accuracy

Known and unknown market pressures

Known and unknown technology opportunities

Validation of capabilities of function

Cost vs. benefit

3 Auxiliary Issues

3.1 References and Contacts

Documents and individuals or organizations used as background to the function described; other functions referenced by this function, or acting as “sub” functions; or other documentation that clarifies the requirements or activities described. All prior work (intellectual property of the company or individual) or proprietary (non-publicly available) work must be so noted.

3.1.1 Prior Published Work of UCI and UCI’s Personnel

The methodology and specification of the AdvancedDistributionAutomationSystem Function for current power system conditions have been developed, and prototype (pilot) and system-wide projects in several North-American utilities have been implemented by Utility Consulting International and its client utilities prior to the IECSA project.

1. Experience of System - Wide Distribution Automation At JEA, Don C. Gilbert, Nokhum Markushevich and Alex Fratkin, Distributech 2004 conference
2. Distribution Volt And Var Control In Emerging Business Environment, Nokhum Markushevich (UCI) and Ron Nielsen (B.C.Hydro), CEA Technologies Distribution Automation Seminar, Halifax, Nova Scotia, Canada. June, 2003
3. Strategic Operations of Distribution Systems in the Future, Nokhum Markushevich, Frances Cleveland, The DER/AdvancedDistributionAutomationSystem Project Stakeholder Team Formation Workshop, March 17-18, 2003

4. The Specifics Of Coordinated Real-Time Voltage And Var Control In Distribution, Nokhum S. Markushevich, Utility Consulting International (UCI), Distributech 2002 Conference
5. Distribution Automation Pilot Project Using the Utility Communications Architecture (UCA®) at City Public Service of San Antonio, EPRI , Palo Alto, CA: 2002. 1007066
6. Capacitor Control In Distribution Automation At OG&E, Aleksandr P. Berman, Nokhum S. Markushevich (UCI), and James C. Clemmer (OG&E), Distributech 2001 Conference
7. Performance Of Advanced DA Applications Implemented in JEA , Nokhum S. Markushevich (UCI), Charles J. Jensen (JEA), Alex I. Fratkin (UCI), and Jerry Knowles (JEA), Distributech 2001 Conference
8. Adaptive Control Of Multiple Protective Devices In The Distribution Automation System At JEA, Charles J. Jensen (JEA), Nokhum S. Markushevich and Aleksandr P. Berman (UCI), Distributech 2001 Conference,
9. Implementation Of Advanced Distribution Automation In Us Utilities, Nokhum S. Markushevich and Aleksandr P. Berman (Utility Consulting International), Charles J. Jensen (JEA), James C. Clemmer (OG&E), USA, CIRED Conference, Amsterdam, 2001
10. Advanced Network Applications In The Distribution Management System At City Public Service Of San Antonio, G. Hitzfelder (CPS), I. Roytelman, B. Nikolic, R. Horn (Siemens PT & D), N. Markushevich (UCI), Distributech 2001 Conference,
11. Implementation Of Advanced Distribution Automation At JEA And OG&E, Charles J. Jensen (JEA), James C. Clemmer (OG&E), Nokhum S. Markushevich (UCI), DA/DSM Distributech Conference, January 2000, Miami, Florida
12. Distribution Automation Pilot Projects At JEA And OG&E,. New Ideas For Remote Voltage And Var Control, Charles J. Jensen, James C. Clemmer Nokhum S. Markushevich, DA/DSM Distributech Conference, January 1999
13. Distribution Automation Project For The Peninsular Malaysian Distribution System, E. Chan, M Delson, N, Markushevich, K. Walston, Ir. T.A. Zaharuddin, and Jamal A. Nasir, CEPSI Conference, 1998.
14. Dynamic System Load Control through Use of Optimal Voltage and Var Control, Nokhum Markushevich, Ron E. Nelson, 1998 Dynamic Modeling Control Applications for Industry Workshop, IEEE Industry Application Society, 1998, Vancouver, Canada
15. Optimizing Feeder Sectionalizing Points for Distribution Automation, Charles Jensen, Nokhum Markushevich, Alex Berman, DA/DSM Distributech Conference, January 1998, Tampa, Florida.
16. Analysis of Capacitor Control Under Conditions of Distribution Automation at OG&E, Nokhum Markushevich, James Clemmer, Alex Berman, Alla Royz, DA/DSM Distributech Conference, January 1998, Tampa, Florida.
17. Distribution Automation Pilot Project at Georgia Power Company, , EPRI , Palo Alto, CA: 1997. TR-109486

18. The Impact of Simplification of the Distribution System Model on the Benefits of Voltage and Var Control, Nokhum Markushevich, Alex Berman, Dan Nordell, Craig Halverson; DA/DSM Distributech Conference, January 1997, San Diego, California.
19. Justification and Planning of Distribution Automation, Edward H.P. Chan, Nokhum S. Markushevich; CEPsi Conference, September 1996, Malaysia
20. Impact Of Automated Voltage/Var Control In Distribution On Power System Operations, Nokhum S. Markushevich, R.E. Nielsen, A.K. Nakamura, J.M. Hall, R.L. Nuelk; DA/DSM Conference January 1996, Tampa, Florida.
21. Update on DA Pilot Project at B.C. Hydro, Nokhum S. Markushevich Ron E. Nielsen, Fifth DA/DSM Conference January 1995, San Jose, California
22. Load to Voltage Dependency Tests at B.C. Hydro, Alf Dwyer, Ron Nielsen, Joerg Stangl, Nokhum S. Markushevich; IEEE/PES 1994 Summer Meeting, July 1994
23. Modeling Distribution Automation, Nokhum S. Markushevich; DA/DSM Conference, January 1994, Florida
24. Planning a Distribution Automation Pilot Project at B.C. Hydro, Nokhum S. Markushevich, Martin Delson, Erik Benedictson, Alf Dwyer, Ivan Herejk, Carl Kober, Ron Nielsen, Joerg Stangl; DA/DSM Conference, January 1994, Florida
25. Integration Of Distribution Automation into Power System Operation, Edward H.P. Chan, Nokhum S. Markushevich; DA/DSM Conference, January 1994, Florida
26. Cost-Benefit Study for Distribution Automation at B.C. Hydro, Nokhum S. Markushevich, Ivan C. Herejk, Ron E. Nielsen ,Utility Consulting International, USA, , Distribution 2000 Conference, November 1993, Australia
27. Functional Requirements and Cost-Benefit Study for Distribution Automation at B.C. Hydro, Nokhum S. Markushevich, I.C. Herejk, Ron Nielsen, 1993 IEEE
28. Voltage and VAR Control in Automated Distribution Systems, Nokhum S. Markushevich; DA/DSM Conference, January 1993, Palm Springs, California
29. Intelligent Alarm Processing, Electric Power Research Institute (EPRI) TR-101576, Research Project #2944-04, Nokhum Markushevich, E.H. Chan, J. Birchfield. December 1992
30. Real Time Optimization of Power System Steady State Operating Conditions for Voltage and Reactive Power, N.B. Vladimirova, V.Costyushko, N.S. Markushevich, V.A. Timofeyev, N.P. Yemelyanov (USSR); CIGRE,September 1990
31. Method of Capacitor Automatic Control, Nokhum S. Markushevich, Certificate of Invention, USSR # 1275409, 1986.

32. Device for Automatic Voltage Control in Electric Networks, V.I. Zak, Nokhum S. Markushevich, Certificate of Invention, USSR # 1288816, 1985.
33. Voltage Control and Electric Energy Conservation, Nokhum S. Markushevich, Moscow: Energoatomizdat, 1984, pp.1-100. Sofia: Technika, 1987, pp. 1-84.
34. Automated Control of 6-20 kV Electric Network Operations, Nokhum S. Markushevich. Moscow: Energiya, 1980, pp. 1-208.
35. Device for Reactive Power Source Control, Nokhum S. Markushevich, Certificate of Invention USSR. # 922703, 1981.
36. Enhancement of the Authenticity of the Electric Network Power Flow Calculation, Nokhum S. Markushevich, Elektrichestvo, # 12, 1979, pp. 1-5.
37. Voltage Quality in Urban Electric Networks, Nokhum S. Markushevich, L.A. Soldatkina. Moscow: Energiya, 1975, pp. 1-256
38. Automatic Frequency Load Shedding in USSR Power Systems, G.Boutin, N. Markushevich, M. Portnoy, et al. CIGRE, 34-04, 1972
39. Under-Frequency Load Shedding as a Means for Automatic Elimination of Emergencies, J.D. Barkan, Nokhum S. Markushevich, R.R. Rudzitis, V.N. Golubev, Elektricheskie Stancii # 5, 1966, pp. 74-78.
40. Selective System of Automatic Reclosing after Automatic Frequency Load Shedding, Nokhum S. Markushevich, Elektricheskie Stancii, #7 1964, pp. 71-73.

ID	Title or contact	Reference or contact information
[1]		
[2]		

3.2 Action Item List

As the function is developed, identify issues that still need clarification, resolution, or other notice taken of them. This can act as an Action Item list.

ID	Description	Status
	Distribution Operation Modeling and Analysis (DOMA)	Developed by UCI; specified by UCI for development by DMS vendors; Partially developed by Siemens and is under development by ALSTOM based on UCI specification. Needs additional development for distribution with significant penetration of DER and power electronics, and for looped

		distribution. EMS applications should be modified to utilize the output from DOMA
2	Fault Location, Isolation and Service Restoration (FLIR)	Developed by UCI and also by Siemens; specified by UCI for development by DMS vendors; is under development by ALSTOM based on UCI specification. Needs additional development for distribution with significant penetration of DER and power electronics, for looped distribution, and for new technological advances in fault anticipation and location.
3	Contingency Analysis (CA)	Developed by UCI. Needs additional development for distribution with significant penetration of DER and power electronics and for looped distribution.
4	Multi-level Feeder Reconfiguration (MFR)	Developed by UCI and also by Siemens; specified by UCI for development by DMS vendors; is under development by ALSTOM based on UCI specification. Needs additional development for distribution with significant penetration of DER and power electronics.
5	Relay Protection Re-coordination (RPR)	Developed by UCI. Needs additional development for distribution with significant penetration of DER and power electronics and for looped distribution.
6	Voltage and Var Control (VVC)	Developed by UCI; specified by UCI for development by DMS vendors. Based on UCI specification, developed by Siemens and is under development by ALSTOM. Needs additional development for distribution with significant penetration of DER and power electronics and for looped distribution. EMS network analysis functions and emergency control function should be modified and interfaced with VVC
7	Prearming of Remedial Action Schemes (RAS)	Needs to be developed and interfaces with the emergency control function of EMS and with intelligent RAS
8	Coordination of emergency actions	Needs to be developed and interfaces with the emergency control function of EMS and with intelligent RAS
9	Coordination of restorative actions	Needs to be developed and interfaces with the emergency control function of EMS and with intelligent RAS
10	Intelligent Alarm Processing	Needs to be developed for distribution with

3.3 Revision History

For reference and tracking purposes, indicate who worked on describing this function, and what aspect they undertook.

No	Date	Author	Description
01.	10/16/03	Nokhum Markushevich, Mark Lachman	Draft 01 prepared. Needs more formatting.
02	10/19	Frances Cleveland	Review 2.1, Revised 2.4, added Fig.2
0.3	10/20	Nokhum Markushevich	Revised 2.1, edited Fig. 2
0.4	10/21	Nokhum Markushevich	Amended 2.4 and Fig.1
05	10/29	Nokhum Markushevich	Added X.8 to 2.3 and amended 2.4 with more details for X.7 and with X.8.
06	11/7	Frances Cleveland	Reorganized and elaborated on functions
06		Mark Lachman	Reorganized and elaborated on functions
07	12/09	Nokhum Markushevich	Revised the elaborated functions, added Fig.2.1
08	02/29/04	Mark Lachman Nokhum Markushevich	Developed UMS diagrams, added power point illustrations and clarifications, revised the step-by-step descriptions of the sub-functions.

This page intentionally left blank.

Data Acquisition and Control (DAC) Use Case

1 Descriptions of Function

All prior work (intellectual property of the company or individual) or proprietary (non-publicly available) work should be so noted.

1.1 Function Name

Data Acquisition and Control (DAC) Function

1.2 Function ID

IECSA identification number of the function

G-3.6,G-3.7,G-3.8,G-3.8.1,G-3.8.2,G-4,T-4.1,T-4.2,T-4.3,T-4.6,T-4.15,T-4.18,T-6,T-6.17,T-6.18,T-6.19,T-6.21,T-9,D-4,D-5,D-6,L-2,L-2.2,L-2.2.1,L-2.4

1.3 Brief Description

Describe briefly the scope, objectives, and rationale of the Function.

Scope: The Data Acquisition and Control (DAC) function, used in transmission and distribution operations, comprises multiple types of mechanisms for data retrieval from field equipment and the issuing of control commands to power system equipment in the field, including among field devices, between field devices and systems located in substations, and between field devices and various systems (including, but not limited to, SCADA systems) located in DER and utility control centers and engineering/planning centers.

Objectives: The DAC function provides real-time data, statistical data, and other calculated and informational data from the power system to systems and applications that use the data. The DAC function also supports the issuing of control commands to power system equipment and the setting of parameters in IEDs and other field systems.

Rationale: Power system real-time data is source of most information required for power system operations. Control over the power system equipment can be achieved by issuing control commands and setting parameters.

1.4 Narrative

A complete narrative of the Function from a Domain Expert's point of view, describing what occurs when, why, how, and under what conditions. This will be a separate document, but will act as the basis for identifying the Steps in Section 2.

The Data Acquisition and Control (DAC) function, used in transmission and distribution operations, comprises multiple types of mechanisms for data retrieval and issuing of control commands to power system equipment. These mechanisms are often used in conjunction with each other to provide the full range of DAC interactions. The DAC function, in turn, is used by other functions, such as Supervisory Control and Data Acquisition (SCADA) systems, Energy Management Systems (EMS), Protection Engineering systems, and Advanced Distribution Automation (ADA), as the means for their interactions with the power system equipment. The different mechanisms include the following:

1.4.1 Direct Power Equipment Control

Direct power equipment control is performed by an Intelligent Electronic Device (IED), a Remote Terminal Unit (RTU), or other microprocessor-based controller, sometimes based on internally generated control commands and sometimes based on externally requested control commands. These controllers monitor sensors for data about the power system and their associated power equipment (the actual equipment connected to the power system). The communications links are often very short (a few meters) but can also entail multi-mile links. The communications media typically are copper wires or optical fibers, but can include power line carrier, radio-based media, and possibly other media. They either use internal applications or are instructed by other entities to issue control signals to associated power system equipment. For example:

- A Load Tap Changer IED raises and lowers the transformer tap position according to pre-set algorithms, based on voltage levels sensed by Potential Transformers (PTs).
- A circuit breaker IED issues an electro-mechanical or solid-state-based trip signal to a circuit breaker.
- A DER IED controller senses status and measurements of a DER generator and its prime mover, and then issues start and stop signals.

1.4.2 Local IED Interactions

Local interactions among Intelligent Electronic Devices (IEDs) are undertaken to respond to a relatively local situation. The communications media are typically LANs, point-to-point cables, and point-to-multi-point radio channels. Protection actions require very high speed communication channels, with response timeframes of 1 to 4 milliseconds. For example:

- A protection IED issues a trip command over a high speed LAN to a circuit breaker IED within a substation, based on its detection of different power system measurements, such as low frequency, current overload, etc.
- Multiple automated switch IEDs, using point-to-multi-point spread spectrum radio communications media, respond to a fault condition on a feeder segment by opening and closing switches to isolate the fault and restore power to unaffected feeder segments.

1.4.3 Computerized Field Systems Monitoring and Control of Field Equipment via IEDs

Computerized field systems perform monitoring and control of field equipment via IEDs, such as a data concentrator or substation master or Automated Control and Data Acquisition (ACADA) (SCADA in a control center is considered in Section 1.4.5). These are generalized systems, as opposed to IEDs or controllers, and usually monitor and/or control more than one power system device. Data concentrators just pass data through them, acting primarily as communication nodes, although they may include a local database. Substation masters may include applications to perform some local interactions, or may help coordinate IED actions. ACADA systems may perform closed loop control (e.g. does not interact with the human operator before issuing a control command).

The communications media can be LANs, copper wire, optical cables, microwave, radio, leased telephone lines, cellphones, and many other types. Data exchanges range from a few 10's of milliseconds up to 1 second. Examples include:

- Data concentrator in a substation monitors data from IEDs that are located on feeders connected to the substation. It passes some of this data to a SCADA system and passes control commands from the SCADA to the IEDs. It may collect sequence of events data and some statistical information in a database.
- Substation master coordinates the protection settings of substation IEDs based on requests from the SCADA system for different response patterns. For instance, different protection trigger levels are set for recloser responses if a storm is pending, or if reconfiguration of a feeder impacts the expected fault current level, or if DER generation levels could cause fuses to blow unnecessarily.
- Substation master provides information to automated switch IEDs on a feeder as to the actual configuration of a neighboring feeder. This information will permit the automated switch IEDs to take more appropriate action if a fault occurs.
- Automatic Control and Data Acquisition (ACADA) performs Advanced Distribution Automation, by responding to field conditions reported by IEDs and issuing control commands for volt/var optimization, fault location, isolation, and restoration, multi-feeder reconfiguration, and other ADA functions..

1.4.4 DER Management Systems Monitoring and Control of DER Devices

DER management systems perform monitoring and control of a DER device, either at a customer site or within a substation (see Figure 1-1). The DER management system could be a DER owner's SCADA system, a customer's Building Automation System (BAS), or an energy aggregator's SCADA system. Communications media can include virtually any type, so long as response times of a few seconds can be accommodated. Examples include:

- Loss of power is detected at a customer site. The backup diesel generator starts up, the automatic transfer switch connecting the customer to the utility EPS opens, and the generator is connected to the customer's local EPS (or just the critical equipment).
- The owner of the DER device decides to reduce his load on the utility EPS by increasing generation. The DER operator implements this decision by setting new parameters in the DER management system. (These are manual actions by persons.) As an automated result, another generator is started by the DER management system, synchronized with the local EPS, and interconnected.
- An energy aggregator sets groups of DER devices to cycle on and off over the next day, taking into account pollution limits, the real-time price of energy, and contractual arrangements with the owners of the DER devices.
- While a DER device is interconnected with the utility EPS, a fault occurs on the feeder. The DER management system ensures that the DER device either trips off or the interconnection circuit breaker opens.
- The DER management system collects sequence-of-events, performance data, and statistical information from DER devices in a substation.

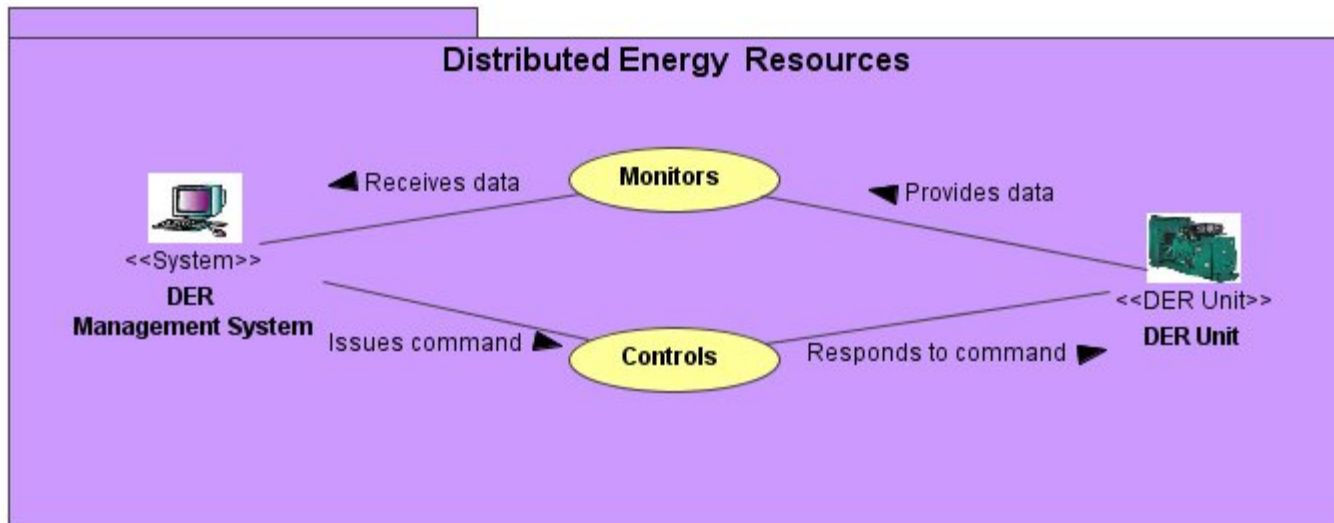

Figure 1-1: DER Management Systems Monitoring and Control of DER Devices

1.4.5 SCADA Systems Monitoring and Control of Field Equipment and IEDs

SCADA systems perform remote monitoring and control of field equipment and IEDs (see **Error! Reference source not found.**). The term “SCADA” is used here to imply any centralized system which retrieves data from remote sites and may issue control commands when authorized. These SCADA systems are typically located in a utility control center, but may include an engineering “SCADA” system which retrieves protection data or disturbance data, or a maintenance “SCADA” system which monitors the health of both power system and communications equipment.

SCADA system monitoring can use communication channels directly to IEDs, via Remote Terminal Units (RTUs), through a data concentrator, through a substation master, or through a DER management system. The communications media can include virtually any type, so long as response times of 1 second can be accommodated. Although typically seen as used only for real-time distribution operations, the data acquired by the SCADA system can be used by many different systems, applications, and personnel in the control center. This Use Case is limited to the monitoring and control function by SCADA systems; other Use Cases (e.g. ADA Use Case) describe their interactions with the SCADA systems.

SCADA system monitoring and control examples include:

- Power system operations SCADA system receives real-time data from power system equipment via:
 - RTUs

- IEDs inside substations
- IEDs along feeders
- Substation masters
- DER (or other generation) management systems
- Other control centers
- Manual entry
- Power system operations SCADA system issues control commands to power system equipment in real-time via:
 - RTUs
 - IEDs inside substations
 - IEDs along feeders
 - Substation masters
 - DER (or other generation) management systems
 - Other control centers (if authorized)
- Power system operations SCADA system receives metering information
- Data management “SCADA” system receives power equipment configuration data from devices. It may have its own communication channels to the remote sites, or it may acquire this data through the distribution operations SCADA system
- Engineering “SCADA” system receives sequence of events data, oscillographic data (special handling required), historical data, and statistical data. It may have its own communication channels to the remote sites, or it may acquire this data through the distribution operations SCADA system
- Maintenance “SCADA” system receives data related to the health of power system equipment and communications equipment. It may have its own communication channels to the remote sites, or it may acquire this data through the distribution operations SCADA system.
- Planning “SCADA” system receives data that can be used for statistical analysis of power system measurements: maximums, minimums, averages, trends, profiles, power quality metrics, etc, needed for short and long term planning.

Figure 1-2: Data Acquisition and Control (DAC) in SCADA Operations on the Power System

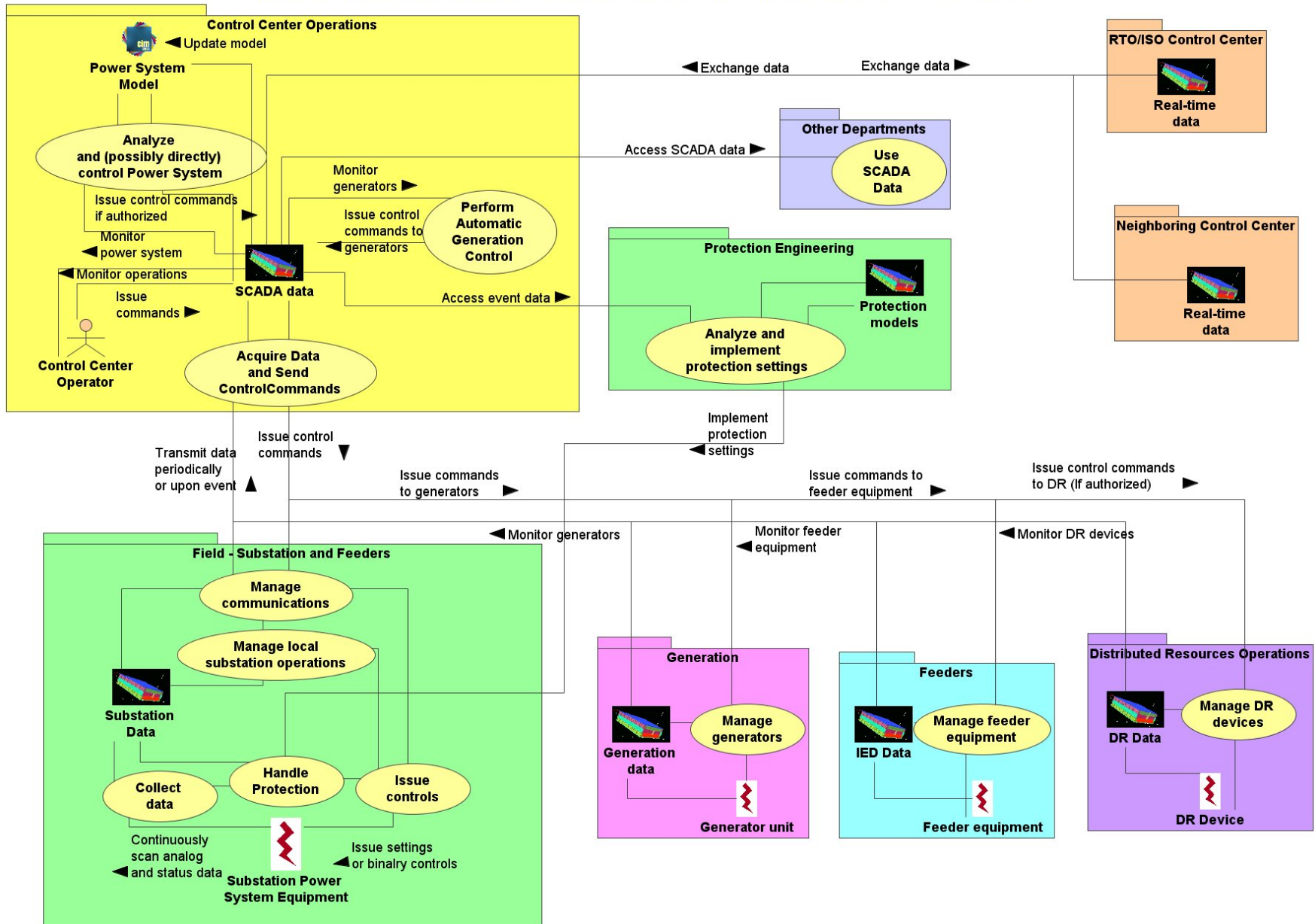

1.5 Actor (Stakeholder) Roles

Describe all the people (their job), systems, databases, organizations, and devices involved in or affected by the Function (e.g. operators, system administrators, technicians, end users, service personnel, executives, SCADA system, real-time database, RTO, RTU, IED, power system). Typically, these actors are logically grouped by organization or functional boundaries or just for collaboration purpose of this use case. We need to identify these groupings and their relevant roles and understand the constituency. The same actor could play different roles in different Functions, but only one role in one Function. If the same actor (e.g. the same person) does play multiple roles in one Function, list these different actor-roles as separate rows.

1.5.1 Actors – Power System Field Equipment

<i>Grouping (Community)'</i>		<i>Group Description</i>
<i>Power System Field Equipment</i>		
<i>Actor Name</i>	<i>Actor Type (person, device, system etc.)</i>	<i>Actor Description</i>
Power system equipment	Device	Power system equipment directly operates on the power system. It can be located anywhere on the power system. Common power system equipment includes CircuitBreaker, Load tap changers, capacitor banks, switches, VoltageRegulatorController, potential transformers (PTs), current transformers (CTs), meters, distributed energy resources (DER) devices, etc.
SensorDevice	Device	SensorDevice directly measure or monitor the power system, typically consisting of PTs and CTs.

<i>Grouping (Community)'</i>		<i>Group Description</i>
<i>Power System Field Equipment</i>		
<i>Actor Name</i>	<i>Actor Type (person, device, system etc.)</i>	<i>Actor Description</i>
RemoteTerminalUnit	Device	An RTU collects data from power system equipment by converting sensor analog data into digital data. This digital data, in the form of status and analog "points" is then transmitted to a system over a communications channel. An RTU issues control actions by converting digital commands received from a system into electro-mechanical or solid-state actions that act on power system equipment. Some RTUS can also monitor and issue control commands to IEDs. They are generalist DAC devices, and do not normally include any applications associated with specific power system equipment. (If they do, they should be termed an IED or controller.)
IED or Controller	Device	An IED or a controller (deemed not quite as intelligent as an IED) controls the power system equipment. It also usually monitors power system data that is relevant to its possible control actions. It can be located in substations, along feeders, at customer sites, or anywhere where power system equipment is located
Substation master	System	A substation master collects data from IEDs, controllers, and power system equipment in substations. It could also collect data from distribution feeder equipment, although this is rarely done, since most substation masters are in large transmission substations as part of substation automation systems. It can also pass through control commands received from other systems.
DataConcentrator	System	A data concentrator is similar to substation master in configuration (i.e. located in a substation to collect data), but it is less likely to play an active role in responding to events. Collects data from IEDs, controllers, and power system equipment in substations. It can also pass through control commands received from other systems.
FieldPersonnel	Person	Work on power system equipment in the field, as instructed by work orders and as authorized by the distribution operator or other utility personnel
MaintenancePersonnel	Person	Maintains all field equipment, devices, and systems

<i>Grouping (Community)'</i>		<i>Group Description</i>
<i>Power System Field Equipment</i>		
<i>Actor Name</i>	<i>Actor Type (person, device, system etc.)</i>	<i>Actor Description</i>
capacitor bank switches		
DERManagementSystem		
DEROperator		
DEROwner		
DERDevice		
Equipment		
LoadTapChangeController		
Protection		
RecloserDevice		
CircuitBreaker		
VoltageRegulatorController		

1.5.2 Actors – Control Center

<i>Grouping (Community)'</i>		<i>Group Description</i>
<i>Control Center</i>		
<i>Actor Name</i>	<i>Actor Type (person, device, system etc.)</i>	<i>Actor Description</i>
Regional System Operator	Person	Regional System Operator monitor the power system using the User Interface of the SCADA system, as well as getting additional information from field crews and other control center systems. They also issue control commands to be executed either electronically through the SCADA system or manually by field crews.
SCADA System	System	The SCADA System retrieves data from the power system equipment, devices, and systems, and is used by operators and authorized applications to issue commands to power system equipment, devices, and systems.
Real time database	Database	The real-time database stores real-time data, primarily for the SCADA applications and user interface used by the distribution operators.
FieldEquipmentDatabase	Database	FieldEquipmentDatabase store data from field equipment that is needed by non-SCADA applications and systems, such as EMS applications, ADA applications, maintenance systems, planning systems, engineering analysis systems, etc. They can include some of the real-time database information, but also contain additional field data not needed by the SCADA operations. These databases are typically not in one system, but are often attached to applications and systems that use the data. Examples include disturbance analysis files, oscillographic data, protection data, maintenance data, and sequence of events data.
Power system applications	Software application	Power system applications, such as WAMACS, EMS, and ADA applications, use data from the real-time database and some application databases, as well as other control center database, to model the power system, analyze conditions, recommend response actions, and, if authorized, issue commands to field equipment.

Replicate this table for each logic group.

1.6 Information exchanged

Describe any information exchanged in this template.

<i>Information Object Name</i>	<i>Information Object Description</i>
Raw sensor data	Raw (unprocessed) data from sensors and field equipment
Signal data	Control commands: can be contact closures, relaying signals, or digital commands
Sensor data	Electrical parameters, status of equipment
Fault sensor data	Fault indication: overcurrent, low frequency, etc
Trip command	Trip signal
Control response sensor data	Electrical measurements (indicating no power)
Digital electric data	Status and measurements
Settings	Parameter values such as voltage level trigger points or wait time for reclose attempt – these may be measurement values or state values (on/off)
IED SOE	Timestamped sequence of event data
SBO control request	Control command, security authorization information, select before operate sequence
Call by person	Voice or written words
DER data entry	Amount of additional generation
DER start-up command	Start command and additional parameters
DER reporting	DER status, generator data, electrical data, prime mover data, fuel data, environmental data
DER historical and statistical records	DER status, generator data, electrical data, prime mover data, fuel data, environmental
DER stop command	Stop command and other pertinent parameters
User display	DER status, generator data, electrical data, prime mover data, fuel data, environmental data
Association	Protocol parameters Information on RTU or IED configuration and available data List of available data Information on groups of data (data sets) to be sent under different circumstances
Status change	Digital status

<i>Information Object Name</i>	<i>Information Object Description</i>
Measurement change	Digital measurement values
Control command	Control commands to power system equipment Control command to IED to initiate an IED process
Parameter setting	Raise/lower settings Threshold and limit settings State conditions
Request	Requested data
SCADA SOE	Log of timestamped events showing data changes and other values

1.7 Activities/Services

Describe or list the activities and services involved in this Function (in the context of this Function). An activity or service can be provided by a computer system, a set of applications, or manual procedures. These activities/services should be described at an appropriate level, with the understanding that sub-activities and services should be described if they are important for operational issues, automation needs, and implementation reasons. Other sub-activities/services could be left for later analysis.

<i>Activity/Service Name</i>	<i>Activities/Services Provided</i>
Association	Establishes an association between two or more entities. It also handles aborts and cancellation of associations
Monitoring analog sensor data	Monitor data from sensors and convert the sensor input into digital integers or floating point numbers
Monitor binary sensor data	Monitor data from sensors and convert the sensor input into digital bits or bytes or integers
Issue binary control commands	Issue control commands
Get data	Request information to be sent, including both measured data and metadata
Set data	Send information to be used or stored, including both values and metadata. This service is used for binary control commands, setpoint control commands, setting parameters, and writing descriptions

<i>Activity/Service Name</i>	<i>Activities/Services Provided</i>
Data set management	Group data values into sets for efficient transmittal. Data Sets can be created by database administrators either typing in lists of data or by browsing metadata databases and selecting the appropriate data items. Applications can also automatically create and delete Data Sets by accessing metadata databases.
Report control	Manage the reporting of Data Sets upon request, at a particular periodicity (e.g. integrity scan), and upon the occurrence of pre-specified events, such as data change (e.g. closed to tripped status), quality change (e.g. a problem causes data to be invalid), data update (e.g. an accumulator value is “frozen” periodically), or integrity scan mismatch (e.g. the integrity scan indicates a different status value from the value that was last reported).
Logging control	Manage logging and journaling of information, such as sequence of events
Substitution values	Manage the substitution of values if these are indicated in the Data Object classes
High speed messages	Handle special ultra-high-speed messaging to multiple destinations, typically for protective relaying
Select-Before-Operate Control	Implement the safety mechanisms used by most switch-related control commands. This procedure basically consists of: an originator of the control command first issuing a select of the control point, the receiver then performing a select and reporting the results back to the originator, the originator then issuing an execute command which the receiver performs only if it receives the execute command within a pre-specified time from the originator.
Time management	Handle the synchronization of time across all interconnected nodes
File transfer	Handle the transfer of files between entities, without treating them as data objects. This capability supports the uploading of new applications into the IEDs and other servers.

1.8 Contracts/Regulations

Identify any overall (human-initiated) contracts, regulations, policies, financial considerations, engineering constraints, pollution constraints, and other environmental quality issues that affect the design and requirements of the Function.

<i>Contract/Regulation</i>	<i>Impact of Contract/Regulation on Function</i>
Provide power system data and permit control of power system equipment	Requires data to be provided and control to be allowed

<i>Policy</i>	<i>From Actor</i>	<i>May</i>	<i>Shall Not</i>	<i>Shall</i>	<i>Description (verb)</i>	<i>To Actor</i>
Authorization	Regional System Operator			X	Authorize all control actions, either as pre-set parameters or as real-time commands	IEDs, Substation masters

<i>Constraint</i>	<i>Type</i>	<i>Description</i>	<i>Applies to</i>
Laws of physics	Natural	Power systems react to the laws of physics Communications media act according to the laws of physics and Claude Shannon	Power system actions Communications media and information encoding

2 Step by Step Analysis of Function

Describe steps that implement the function. If there is more than one set of steps that are relevant, make a copy of the following section grouping (Preconditions and Assumptions, Steps normal sequence, and Steps alternate or exceptional sequence, Post conditions)

2.1 Steps to implement function

Name of this sequence.

2.1.1 Preconditions and Assumptions

Describe conditions that must exist prior to the initiation of the Function, such as prior state of the actors and activities

Identify any assumptions, such as what systems already exist, what contractual relations exist, and what configurations of systems are probably in place

Identify any initial states of information exchanged in the steps in the next section. For example, if a purchase order is exchanged in an activity, its precondition to the activity might be 'filled in but unapproved'.

<i>Actor/System/Information/Contract</i>	<i>Preconditions or Assumptions</i>
Field equipment, IEDs, Substation master, data concentrator, SCADA system	Equipment, devices and systems must be installed and operational

2.1.2 Steps – Normal Sequence

Describe the normal sequence of events, focusing on steps that identify new types of information or new information exchanges or new interface issues to address. Should the sequence require detailed steps that are also used by other functions, consider creating a new “sub” function, then referring to that “subroutine” in this function. Remember that the focus should be less on the algorithms of the applications and more on the interactions and information flows between “entities”, e.g. people, systems, applications, data bases, etc. There should be a direct link between the narrative and these steps.

The numbering of the sequence steps conveys the order and concurrency and iteration of the steps occur. Using a Dewey Decimal scheme, each level of nested procedure call is separated by a dot ‘.’. Within a level, the sequence number comprises an optional letter and an integer number. The letter specifies a concurrent sequence within the next higher level; all letter sequences are concurrent with other letter sequences. The number specifies the sequencing of messages in a given letter sequence. The absence of a letter is treated as a default ‘main sequence’ in parallel with the lettered sequences.

Sequence 1:

*1.1 - Do step 1
1.2A.1 - In parallel to activity 2 B do step 1
1.2A.2 - In parallel to activity 2 B do step 2
1.2B.1 - In parallel to activity 2 A do step 1
1.2B.2 - In parallel to activity 2 A do step 2
1.3 - Do step 3
1.3.1 - nested step 3.1
1.3.2 - nested step 3.2*

Sequence 2:

*2.1 - Do step 1
2.2 - Do step 2*

2.1.2.1 Steps for Direct Power Equipment Control by IEDs

An IED receives sensor data from a Potential Transformer (PT), or a circuit breaker IED issues a trip signal to a circuit breaker device.

#	Event	Primary Actor	Name of Process/Activity	Description of Process/Activity	Information Producer	Information Receiver	Name of Info Exchanged	Additional Notes	IECSA Environments
#	Triggering event? Identify the name of the event. ¹	What other actors are primarily responsible for the Process/Activity? Actors are defined in section 1.5.	Label that would appear in a process diagram. Use action verbs when naming activity.	Describe the actions that take place in active and present tense. The step should be a descriptive noun/verb phrase that portrays an outline summary of the step. "If ...Then...Else" scenarios can be captured as multiple Actions or as separate steps.	What other actors are primarily responsible for Producing the information? Actors are defined in section 1.5.	What other actors are primarily responsible for Receiving the information? Actors are defined in section 1.5. (Note – May leave blank if same as Primary Actor)	Name of the information object. Information objects are defined in section 1.5.1	Elaborate architectural issues using attached spreadsheet. Use this column to elaborate details that aren't captured in the spreadsheet.	Reference the applicable IECSA Environment containing this data exchange. Only one environment per step.
1.1	Continuous or very frequent data retrieval	Power system equipment, including associated field device, PTs, and CTs	Monitor sensors	IED performs analog-to-digital and/or digital-to-digital conversions from sensor inputs, retrieving data from its associated power system equipment and from PT and CT sensors. IED then performs basic engineering conversions on the raw data, processes the information, and determines if any subsequent actions are needed based on limit checking and other process results	SensorDevice	IED	Raw sensor data	No: config issue Yes: QoS – – high speed 1-4 ms; retrieval from sensors must be synchronized with sending to other IEDs; access control, accuracy, precision, timing Yes: security – integrity, confidentiality may be an issue Minor issues related to data management Yes: constraints – legacy equipment	Inter-Field Equipment

¹ Note – A triggering event is not necessary if the completion of the prior step – leads to the transition of the following step.

#	Event	Primary Actor	Name of Process/Activity	Description of Process/Activity	Information Producer	Information Receiver	Name of Info Exchanged	Additional Notes	IECSA Environments
1.2	Processed data indicates further local action needed	IED	Send control commands	IED issues control commands to power system equipment, based on the results of processing the input data from the field	IED	Other IEDs or power system equipment, such as CircuitBreaker, VoltageRegulatorController, capacitor bank switches, LoadTapChangeController, RecloserDevice, etc	Signal data	See 1.1	Inter-Field Equipment

2.1.2.2 Steps for Local Interactions Among IEDs

A protection IED issues a trip command over a high speed LAN to a circuit breaker IED within a substation, based on its detection of different power system measurements, such as low frequency, current overload, etc.

#	Event	Primary Actor	Name of Process/Activity	Description of Process/Activity	Information Producer	Information Receiver	Name of Info Exchanged	Additional Notes	IECSA Environments
#	<i>Triggering event? Identify the name of the event.²</i>	<i>What other actors are primarily responsible for the Process/Activity? Actors are defined in section 1.5.</i>	<i>Label that would appear in a process diagram. Use action verbs when naming activity.</i>	<i>Describe the actions that take place in active and present tense. The step should be a descriptive noun/verb phrase that portrays an outline summary of the step. "If ...Then...Else" scenarios can be captured as multiple Actions or as separate steps.</i>	<i>What other actors are primarily responsible for Producing the information? Actors are defined in section 1.5.</i>	<i>What other actors are primarily responsible for Receiving the information? Actors are defined in section 1.5.</i> <i>(Note – May leave blank if same as Primary Actor)</i>	<i>Name of the information object. Information objects are defined in section 1.5.1</i>	<i>Elaborate architectural issues using attached spreadsheet. Use this column to elaborate details that aren't captured in the spreadsheet.</i>	<i>Reference the applicable IECSA Environment containing this data exchange. Only one environment per step.</i>
2.1	Continuous monitoring	Power system equipment	SensorDevice monitoring	Each IED in the group monitors local power system equipment	Power system equipment	IEDs	Sensor data	See 1.1	Inter-Field Equipment
2.2	Fault in a feeder segment occurs	SensorDevice or IED	Fault detection	A fault occurs in a feeder segment. This fault is detected by one or more IEDs, including a protection IED in the substation.	SensorDevice or IED	IED	Fault sensor data	See 1.1	Inter-Field Equipment
2.3	Protection IED issues trip command	Protection IED	Trip command	The protection IED issues a trip command to the recloser IED. Using the mechanisms described in section 2.2.1, the recloser IED issues a trip command to its recloser.	Protection IED	Equipment	Trip command	See 1.1	Inter-Field Equipment

² Note – A triggering event is not necessary if the completion of the prior step – leads to the transition of the following step.

#	Event	Primary Actor	Name of Process/Activity	Description of Process/Activity	Information Producer	Information Receiver	Name of Info Exchanged	Additional Notes	IECSA Environments
2.4	Recloser trips	SensorDevice or IED	Monitor response to command	The recloser trips and this information is received by automated switch IEDs on the affected feeder.	SensorDevice or IED	IED	Control response sensor data	See 1.1	Inter-Field Equipment
2.5	IED internal analysis results – multiple iterations	One IED	Local IED response to fault	IEDs near faulted feeder segment communicate and determine which switches should be opened and which closed. This occurs a number of times, depending upon the results of the IED actions, the results of the recloser actions, and the parameter settings in the IEDs. Each IED performs its actions via the 2.2.1 process.	One IED	Other IEDs	Digital electric data	<p>Yes: config issue – IEDs may be in distant locations, poor communications</p> <p>Yes: QoS – high speed 1 sec access, accuracy, precision, timing</p> <p>Yes: security – authentication, integrity, confidentiality, prevent denial of service</p> <p>Yes: data management among IEDs requires significant effort</p>	Inter-Field Equipment

2.1.2.3 Steps for Computerized Field Systems Monitoring and Controlling via IEDs

Substation master coordinates the protection settings of substation IEDs based on requests from the SCADA system for different response patterns. For instance, different protection trigger levels are set for recloser responses if a storm is pending, or if reconfiguration of a feeder impacts the expected fault current level, or if DER generation levels could cause fuses to blow unnecessarily.

#	Event	Primary Actor	Name of Process/Activity	Description of Process/Activity	Information Producer	Information Receiver	Name of Info Exchanged	Additional Notes	IECSA Environments
#	Triggering event? Identify the name of the event. ³	What other actors are primarily responsible for the Process/Activity? Actors are defined in section 1.5.	Label that would appear in a process diagram. Use action verbs when naming activity.	Describe the actions that take place in active and present tense. The step should be a descriptive noun/verb phrase that portrays an outline summary of the step. "If ...Then...Else" scenarios can be captured as multiple Actions or as separate steps.	What other actors are primarily responsible for Producing the information? Actors are defined in section 1.5.	What other actors are primarily responsible for Receiving the information? Actors are defined in section 1.5. (Note – May leave blank if same as Primary Actor)	Name of the information object. Information objects are defined in section 1.5.1	Elaborate architectural issues using attached spreadsheet. Use this column to elaborate details that aren't captured in the spreadsheet.	Reference the applicable IECSA Environment containing this data exchange. Only one environment per step.
3.1	On-going monitoring of data by substation master	Multiple IEDs	Data monitoring	Substation master receives digital data from IEDs within a substation and along adjacent feeders. This data can be transmitted periodically or upon significant change of an analog value or upon status change	Multiple IEDs	Substation master	Digital electric data	Config: Many devices, some in the substation, some along feeders. QoS: accuracy and availability are crucial Security: authentication, integrity, and possibly confidentiality Data management: Could become very complex, ensure consistency Constraints: often compute and bandwidth constraints, some legacy systems	Deterministic Rapid Response Intra-Sub

³ Note – A triggering event is not necessary if the completion of the prior step – leads to the transition of the following step.

#	Event	Primary Actor	Name of Process/Activity	Description of Process/Activity	Information Producer	Information Receiver	Name of Info Exchanged	Additional Notes	IECSA Environments
3.2	Request by SCADA to change protection settings	Substation master	Change settings	As requested by the control center SCADA System, the substation master determines the appropriate settings for protective relays and Recloser Device for a specific scenario (e.g. storm, changed feeder configuration)	Substation master	Protection and recloser IEDs	Settings	See 3.1	Deterministic Rapid Response Intra-Sub
3.3	Power system event with IEDs responding	IEDs	Sequence of events recording	A power system event occurs, to which the local IEDs respond. They then report their sequence of events to the substation master for inclusion with disturbance records.	IEDs	Substation master	IED SOE	See 3.1	Deterministic Rapid Response Intra-Sub
3.4	Regional System Operator initiates trip of breaker	Substation master	Select before operate (SBO) command	The substation master ensures that a control request from the control center is authorized, then passes the request to the circuit breaker IED for execution	Substation master	Circuit breaker IED	SBO control request	See 3.1	Deterministic Rapid Response Intra-Sub

2.1.2.4 Steps for DER Management System Monitoring and Control of DER Devices

The owner of the DER device decides to reduce his load on the utility EPS by increasing generation. The DER operator implements this decision by setting new parameters in the DER management system. (These are manual actions by persons.) As an automated result, another generator is started by the DER management system, synchronized with the local EPS, and interconnected.

#	Event	Primary Actor	Name of Process/Activity	Description of Process/Activity	Information Producer	Information Receiver	Name of Info Exchanged	Additional Notes	IECSA Environments
#	Triggering event? Identify the name of the event. ⁴	What other actors are primarily responsible for the Process/Activity? Actors are defined in section1.5.	Label that would appear in a process diagram. Use action verbs when naming activity.	Describe the actions that take place in active and present tense. The step should be a descriptive noun/verb phrase that portrays an outline summary of the step. "If ...Then...Else" scenarios can be captured as multiple Actions or as separate steps.	What other actors are primarily responsible for Producing the information? Actors are defined in section1.5.	What other actors are primarily responsible for Receiving the information? Actors are defined in section1.5. (Note – May leave blank if same as Primary Actor)	Name of the information object. Information objects are defined in section 1.5.1	Elaborate architectural issues using attached spreadsheet. Use this column to elaborate details that aren't captured in the spreadsheet.	Reference the applicable IECSA Environment containing this data exchange. Only one environment per step.
4.1	DEROwner decides to reduce load	DEROwner	Owner decision	DEROwner contacts (calls, e-mails, alarms) DEROperator that additional energy from DER generation is needed.	DEROwner	DEROperator	Call by person	None	Special
4.2	DEROperator enters new parameters	DEROperator	Establish parameters	DEROperator sets new parameters for DER generation output in the DERManagementSystem.	DEROperator	DERManagementSystem	DER data entry	User interface	User Interface

⁴ Note – A triggering event is not necessary if the completion of the prior step – leads to the transition of the following step.

#	Event	Primary Actor	Name of Process/Activity	Description of Process/Activity	Information Producer	Information Receiver	Name of Info Exchanged	Additional Notes	IECSA Environments
4.3	Start command	DERManagementSystem	Start DER	DERManagementSystem issues start command to a DERDevice.	DERManagementSystem	DERDevice	DER start-up command	<p>Config: A few DERDevices in campus-like area.</p> <p>QoS: accuracy and availability are crucial. Protocol “services” are required</p> <p>Security: authentication, integrity, and confidentiality</p> <p>Data management: Report and log data</p> <p>Constraints: No established standard protocols</p>	DER Monitoring and Control
4.4	DER Unit started	DERDevice	Synchronization	DER Unit starts and synchronizes with the Local EPS, and reports success and current operating measurements to DERManagementSystem	DERDevice	DERManagementSystem	DER reporting	See 4.3	DER Monitoring and Control

#	Event	Primary Actor	Name of Process/Activity	Description of Process/Activity	Information Producer	Information Receiver	Name of Info Exchanged	Additional Notes	IECSA Environments
4.5	On-going DERDevice operations	DERDevice	Monitoring DER	DERDevice reports current operating measurements to DERManagementSystem for operational information as well as historical and statistical information	DERDevice	DERManagementSystem	DER historical and statistical records	See 4.3	DER Monitoring and Control
4.6	Environmental limit reached	DERManagementSystem	Environmental limit	DERManagementSystem calculates that a diesel generator has reached its daily (assigned) limit of emissions, and issues a stop command	DERManagementSystem	DERDevice	DER stop command	See 4.3	DER Monitoring and Control
4.7	DERDevice stops	DERDevice	Stop DER	DERDevice stops and shuts down. It reports back to the DERManagementSystem with its latest data	DERDevice	DERManagementSystem	DER reporting	See 4.3	DER Monitoring and Control
4.8	DERDevice reports received	DERManagementSystem	DER reports	DERManagementSystem provides DERDevice data to DEROperator via a User Interface	DERManagementSystem	DEROperator	User display	User interface	User Interface

2.1.2.5 Steps for Monitoring and Control by SCADA System

Distribution operations SCADA system monitors and controls power system equipment via a multitude of mechanisms.

#	Event	Primary Actor	Name of Process/Activity	Description of Process/Activity	Information Producer	Information Receiver	Name of Info Exchanged	Additional Notes	IECSA Environments
#	Triggering event? Identify the name of the event. ⁵	What other actors are primarily responsible for the Process/Activity? Actors are defined in section 1.5.	Label that would appear in a process diagram. Use action verbs when naming activity.	Describe the actions that take place in active and present tense. The step should be a descriptive noun/verb phrase that portrays an outline summary of the step. "If ... Then...Else" scenarios can be captured as multiple Actions or as separate steps.	What other actors are primarily responsible for Producing the information? Actors are defined in section 1.5.	What other actors are primarily responsible for Receiving the information? Actors are defined in section 1.5. (Note – May leave blank if same as Primary Actor)	Name of the information object. Information objects are defined in section 1.5.1	Elaborate architectural issues using attached spreadsheet. Use this column to elaborate details that aren't captured in the spreadsheet.	Reference the applicable IECSA Environment containing this data exchange. Only one environment per step.

⁵ Note – A triggering event is not necessary if the completion of the prior step – leads to the transition of the following step.

#	Event	Primary Actor	Name of Process/Activity	Description of Process/Activity	Information Producer	Information Receiver	Name of Info Exchanged	Additional Notes	IECSA Environments
5.1	Establish an association between SCADASYSTEM and RTU and/or IED	SCADASystem and REMOTETERMINALUNIT/IED	Establish association	Using an interactive process between an RTU or IED and a SCADASystem, an association is established. This interactive process varies from protocol to protocol, but essentially entails setting up what data is available and what data is to be sent under what conditions. In some protocols, many of the steps are manual, while in others they are almost entirely automatic.	SCADASystem and REMOTETERMINALUNIT/IED	REMOTETERMINALUNIT/IED and SCADASystem	Association	<p>Config: 10's to 1000's of field IEDs. May act through data concentrators or substation masters. Acquisition within 1 second</p> <p>QoS: accuracy and availability are crucial. Protocol "services" are required</p> <p>Security: authentication, integrity, and possibly confidentiality</p> <p>Data management: Vast amounts of data requiring acquisition and subsequent transmittal to other users. Consistency of data is important</p> <p>Constraints: Many legacy systems with legacy protocols and limited capabilities</p>	Deterministic Rapid Response Inter Site

#	Event	Primary Actor	Name of Process/Activity	Description of Process/Activity	Information Producer	Information Receiver	Name of Info Exchanged	Additional Notes	IECSA Environments
5.2	Status change occurs in power equipment	IED which is sensing power system equipment	Detect status change	A status change occurs in some power system equipment. This status change is “immediately” sent (usually within 1 second) to the SCADA System. Depending upon the communication “services”, the status value can be sent periodically, or can use the “report-by-exception” service, which sends a status value only if it changes	IED which is sensing power system equipment	SCADA System	Status change	See 5.1	Deterministic Rapid Response Intra-Sub
5.3	“Significant” change in a measurement value	REMOTETER MINALUNIT which is sensing power system equipment	Detect significant measurement change	A significant change occurs in a measured value. (Significant implies it exceeds some pre-established limit.) This changed value is sent according to pre-established protocol services: e.g. <i>report-by-exception</i> sends it immediately (within 1 to 2 seconds), while <i>periodically</i> sends it when the time period elapses. The protocol also determines what information is included, such as timestamp, quality code, etc.	REMOTETER MINALUNIT which is sensing power system equipment	SCADA System	Measurement change	See 5.1	Deterministic Rapid Response Intra-Sub

#	Event	Primary Actor	Name of Process/Activity	Description of Process/Activity	Information Producer	Information Receiver	Name of Info Exchanged	Additional Notes	IECSA Environments
5.4	SCADA issues control command	SCADASystem	Issue control command	Either an operator or an application issues a control command through the SCADASystem to an REMOTETERMINAL UNIT or IED. These control commands are typically immediately implemented by sending a signal to the power system equipment	SCADASystem	REMOTETERMINALUNIT or IED which initiates signals to power system equipment	Control command	See 5.1	Deterministic Rapid Response Intra-Sub
5.5	SCADA sends parameter settings	SCADASystem	Set parameters	Either an operator or an application sends a parameter setting through the SCADASystem to an REMOTETERMINAL UNIT or IED. These parameter settings may be stored for later use or may be used immediately to initiate a signal to the power system equipment, such as a raise or lower control command	SCADASystem	REMOTETERMINALUNIT or IED	Parameter setting	See 5.1	Deterministic Rapid Response Intra-Sub
5.6	SCADA requests specific data	SCADASystem	Request data	Either an operator or an application requests specific data to be sent to the SCADASystem from an REMOTETERMINAL UNIT or IED.	SCADASystem	REMOTETERMINALUNIT or IED	Request	See 5.1	Deterministic Rapid Response Intra-Sub

#	Event	Primary Actor	Name of Process/Activity	Description of Process/Activity	Information Producer	Information Receiver	Name of Info Exchanged	Additional Notes	IECSA Environments
5.7	Sequence of Events log	REMOTETER MINALUNIT or IED	Transmit sequence of events records	An REMOTETERMINAL UNIT or IED has collected Sequence of Events log and initiates its transmittal to the SCADASystem	REMOTETER MINALUNIT or IED	SCADASystem	SCADA SOE	See 5.1	Deterministic Rapid Response Intra-Sub

2.1.3 Steps – Alternative / Exception Sequences

Describe any alternative or exception sequences that may be required that deviate from the normal course of activities. Note instructions are found in previous table.

#	Event	Primary Actor	Name of Process/Activity	Description of Process/Activity	Information Producer	Information Receiver	Name of Info Exchanged	Additional Notes	IECSA Environments

2.1.4 Post-conditions and Significant Results

Describe conditions that must exist at the conclusion of the Function. Identify significant items similar to that in the preconditions section.

Describe any significant results from the Function

<i>Actor/Activity</i>	<i>Post-conditions Description and Results</i>

<i>Actor/Activity</i>	<i>Post-conditions Description and Results</i>

2.2 Architectural Issues in Interactions

Elaborate on all architectural issues in each of the steps outlined in each of the sequences above. Reference the Step by number..



Microsoft Excel
Worksheet

2.3 Diagram

For clarification, draw (by hand, by Power Point, by UML diagram) the interactions, identifying the Steps where possible.

See diagrams in Narrative section.

3 Auxiliary Issues

3.1 References and contacts

Documents and individuals or organizations used as background to the function described; other functions referenced by this function, or acting as “sub” functions; or other documentation that clarifies the requirements or activities described. All prior work (intellectual property of the company or individual) or proprietary (non-publicly available) work must be so noted.

ID	Title or contact	Reference or contact information
[1]	Hundreds of utility operators, SCADA and equipment vendors, consultants, and system specifications that I have read and written over the last (gulp) 30 years.	Frances Cleveland
[2]		

3.2 Action Item List

As the function is developed, identify issues that still need clarification, resolution, or other notice taken of them. This can act as an Action Item list.

ID	Description	Status
[1]		
[2]		

3.3 Revision History

For reference and tracking purposes, indicate who worked on describing this function, and what aspect they undertook.

No	Date	Author	Description
1	October 23, 2003	Frances Cleveland	Revision 1
2	January 25, 2004	Frances Cleveland	Revision 2 to put into final template and make minor updates

Hours ahead load optimization

1 Descriptions of Function

All prior work (intellectual property of the company or individual) or proprietary (non-publicly available) work should be so noted.

1.1 Function Name

Hours ahead load optimization to reduce transmission congestion due to weather forecast fluctuation.

1.2 Function ID

IECSA identification number of the function T.B.D.

1.3 Brief Description

Describe briefly the scope, objectives, and rationale of the Function.

Contingency analysis determines that there is likelihood that there is congestion that can be reduced through load management when a new weather forecast is published.

1.4 Narrative

A complete narrative of the Function from a Domain Expert's point of view, describing what occurs when, why, how, and under what conditions. This will be a separate document, but will act as the basis for identifying the Steps in Section 2.

There is usually a fault or periodic contingency analysis application, “calculator”.

We have monitoring devices throughout the system by the SCADA system. Network analysis applications determine current and expected network state.

In France as in many places in Europe, we are in N-1 level of contingency.

There is a forecasted reduction in capacity due to a sudden drop in weather forecasted temperature. The weather forecast changed within a few hours ahead – so there is some time to respond.

The lines are all constrained and the only way to solve the problem is to ask some area at the distribution level to reduce the level. No additional available power or transmission capacity. Some customers have subscribed to a rate that will allow curtailment or usage of generation capability. This is the first level of addressing of such a problem. If insufficient, more drastic measures would have to be taken. In exchange for the rate the customer makes available a set of loads and load control equipment that can be used when power consumption must be constrained.

We have some form on online continuous contingency calculator that would produce a strategy for alleviating the problem through its execution.

Inputs to the calculator include the optimization functions and their ordering (which may be dynamic depending on other variables). Other inputs will include measurement data, system topology, power flow, critical load database, load behavior prediction or load shapes (what you expect the consumption to look like over time).

We have the choice control transmission or distribution connected load. For transmission, there are people under contract for interruptible options once or twice a year in exchange for attractive rate. Within that class there is a prioritization of those customers.

For example:

- 1) New weather forecast comes in
- 2) Contingency analyzer makes new computation that triggers need for demand response
- 3) Load control strategy is devised.
- 4) Strategy is approved by transmission system operator if less severe
- 5) Strategy is approved by government operative if more severe

- 6) Initiate load control – via a control signal (almost instantaneous) or human contact via phone by the dispatcher (could take minutes)
- 7) Measure or deduce response. If you don't get expected response, go to 2) with new information.
- 8) Audit process verifies individual customer compliance with tariff.
- 9) Also audits the edf services to validate that proper procedure was followed.
- 10) Restore as soon as possible

1.5 Actor (Stakeholder) Roles

Describe all the people (their job), systems, databases, organizations, and devices involved in or affected by the Function (e.g. operators, system administrators, technicians, end users, service personnel, executives, SCADA system, real-time database, RTO, RTU, IED, power system). Typically, these actors are logically grouped by organization or functional boundaries or just for collaboration purpose of this use case. We need to identify these groupings and their relevant roles and understand the constituency. The same actor could play different roles in different Functions, but only one role in one Function. If the same actor (e.g. the same person) does play multiple roles in one Function, list these different actor-roles as separate rows.

<i>Grouping (Community)'</i>		<i>Group Description</i>
<i>Actor Name</i>	<i>Actor Type (person, device, system etc.)</i>	<i>Actor Description</i>
SCADASystem	System	Provides real time power flow information and system
WeatherService	System	Provides temperature and other environmental data predictions as a function of time.
NetworkAnalysis	System	

<i>Grouping (Community)</i>		<i>Group Description</i>
<i>Actor Name</i>	<i>Actor Type (person, device, system etc.)</i>	<i>Actor Description</i>
System		
Customer	Entity	
ControllableCustomerLoad	Device	
CustomerLoadController	Device	
ContingencyAnalysisSystem	System	
TransmissionSystemOperator	Person	
Government operative	Person	
Dispatcher	Person	
<i>edf services</i>	Organization	Sub organization responsible for carrying out contingency plan
<i>AuditingPersonnel</i>	Organization	Responsible for verifying proper operation of the contingency plan from the perspective of the customer site behavior, and, the EDF services performance.
<i>RevenueMeterDevice</i>	Device	
<i>EMSLoadController</i>		

Replicate this table for each logic group.

1.6 Information exchanged

Describe any information exchanged in this template.

<i>Information Object Name</i>	<i>Information Object Description</i>
Weather forecast	
Measurement set	Results provided by SCADA System
State Estimator / Power Flow Results	
Load Control Strategy	
Customer tariff	
Customer Data	Account information
Customer Load Profile	Expected load behavior of customer
Meter data	Instantaneous and historic
Critical load data	Curtailed constraints on customer devices
Load Control Signals	Load shed and service restoration signals
Audit results	Summary of system and customer performance
“Phone conversation”	May be conveyed and / or archived. This is a vocal message, as opposed to a computer encoded one.

1.7 Activities/Services

Describe or list the activities and services involved in this Function (in the context of this Function). An activity or service can be provided by a computer system, a set of applications, or manual procedures. These activities/services should be described at an appropriate level, with the

understanding that sub-activities and services should be described if they are important for operational issues, automation needs, and implementation reasons. Other sub-activities/services could be left for later analysis.

<i>Activity/Service Name</i>	<i>Activities/Services Provided</i>
Load Control	Based on control strategy, send load control signals over various media to customer load control equipment

1.8 Contracts/Regulations

Identify any overall (human-initiated) contracts, regulations, policies, financial considerations, engineering constraints, pollution constraints, and other environmental quality issues that affect the design and requirements of the Function.

<i>Contract/Regulation</i>	<i>Impact of Contract/Regulation on Function</i>
Customer Tariff	
Terms for government involvement	Conditions under which it is necessary to achieve government approval

<i>Policy</i>	<i>From Actor</i>	<i>May</i>	<i>Shall Not</i>	<i>Shall</i>	<i>Description (verb)</i>	<i>To Actor</i>

<i>Constraint</i>	<i>Type</i>	<i>Description</i>	<i>Applies to</i>

2 Step by Step Analysis of Function

Describe steps that implement the function. If there is more than one set of steps that are relevant, make a copy of the following section grouping (Preconditions and Assumptions, Steps normal sequence, and Steps alternate or exceptional sequence, Post conditions)

2.1 Steps to implement function

Name of this sequence.

2.1.1 Preconditions and Assumptions

Describe conditions that must exist prior to the initiation of the Function, such as prior state of the actors and activities

Identify any assumptions, such as what systems already exist, what contractual relations exist, and what configurations of systems are probably in place

Identify any initial states of information exchanged in the steps in the next section. For example, if a purchase order is exchanged in an activity, its precondition to the activity might be 'filled in but unapproved'.

<i>Actor/System/Information/Contract</i>	<i>Preconditions or Assumptions</i>
Tariff in place	

2.1.2 Steps – Normal Sequence

Describe the normal sequence of events, focusing on steps that identify new types of information or new information exchanges or new interface issues to address. Should the sequence require detailed steps that are also used by other functions, consider creating a new “sub” function, then referring to that “subroutine” in this function. Remember that the focus should be less on the algorithms of the applications and more on the interactions and information flows between “entities”, e.g. people, systems, applications, data bases, etc. There should be a direct link between the narrative and these steps.

The numbering of the sequence steps conveys the order and concurrency and iteration of the steps occur. Using a Dewey Decimal scheme, each level of nested procedure call is separated by a dot ‘.’. Within a level, the sequence number comprises an optional letter and an integer number. The letter specifies a concurrent sequence within the next higher level; all letter sequences are concurrent with other letter sequences. The number specifies the sequencing of messages in a given letter sequence. The absence of a letter is treated as a default 'main sequence' in parallel with the lettered sequences.

Sequence 1:

*1.1 - Do step 1
1.2A.1 - In parallel to activity 2 B do step 1
1.2A.2 - In parallel to activity 2 B do step 2
1.2B.1 - In parallel to activity 2 A do step 1
1.2B.2 - In parallel to activity 2 A do step 2
1.3 - Do step 3
1.3.1 - nested step 3.1
1.3.2 - nested step 3.2*

Sequence 2:

*2.1 - Do step 1
2.2 - Do step 2*

#	Event	Primary Actor	Name of Process/Activity	Description of Process/Activity	Information Producer	Information Receiver	Name of Info Exchanged	Additional Notes	IECSA Environments
#	Triggering event? Identify the name of the event. ¹	What other actors are primarily responsible for the Process/Activity? Actors are defined in section0.	Label that would appear in a process diagram. Use action verbs when naming activity.	Describe the actions that take place in active and present tense. The step should be a descriptive noun/verb phrase that portrays an outline summary of the step. "If ...Then...Else" scenarios can be captured as multiple Actions or as separate steps.	What other actors are primarily responsible for Producing the information? Actors are defined in section0.	What other actors are primarily responsible for Receiving the information? Actors are defined in section0. (Note – May leave blank if same as Primary Actor)	Name of the information object. Information objects are defined in section 1.6	Elaborate architectural issues using attached spreadsheet. Use this column to elaborate details that aren't captured in the spreadsheet.	Reference the applicable IECSA Environment containing this data exchange. Only one environment per step.
1	Trigger Load Control	<i>EMSLoadC ontroller</i>	Issue load control	The signal to control the load and supporting is generated and distributed to appropriate	<i>EMSLoadC ontroller</i>	CustomerLoa dController	Load Control Signals		Control Center / Customer Equip

2.1.3 Steps – Alternative / Exception Sequences

Describe any alternative or exception sequences that may be required that deviate from the normal course of activities. Note instructions are found in previous table.

Control load

#	Event	Primary Actor	Name of Process/Activity	Description of Process/Activity	Information Producer	Information Receiver	Name of Info Exchanged	Additional Notes	IECSA Environments

¹ Note – A triggering event is not necessary if the completion of the prior step – leads to the transition of the following step.

2.1.4 Post-conditions and Significant Results

Describe conditions that must exist at the conclusion of the Function. Identify significant items similar to that in the preconditions section.

Describe any significant results from the Function

<i>Actor/Activity</i>	<i>Post-conditions Description and Results</i>

2.2 Architectural Issues in Interactions

Elaborate on all architectural issues in each of the steps outlined in each of the sequences above. Reference the Step by number..



Microsoft Excel
Worksheet

2.3 Diagram

For clarification, draw (by hand, by Power Point, by UML diagram) the interactions, identifying the Steps where possible.

3 Auxiliary Issues

3.1 References and contacts

Documents and individuals or organizations used as background to the function described; other functions referenced by this function, or acting as “sub” functions; or other documentation that clarifies the requirements or activities described. All prior work (intellectual property of the company or individual) or proprietary (non-publicly available) work must be so noted.

ID	Title or contact	Reference or contact information
[1]		
[2]		

3.2 Action Item List

As the function is developed, identify issues that still need clarification, resolution, or other notice taken of them. This can act as an Action Item list.

ID	Description	Status
[1]		
[2]		

3.3 Revision History

For reference and tracking purposes, indicate who worked on describing this function, and what aspect they undertook.

No	Date	Author	Description
0.			

This page intentionally left blank.

Market Operations – Day Ahead Market Operations

1 Descriptions of Functions – Day Ahead Market Operations

All prior work (intellectual property of the company or individual) or proprietary (non-publicly available) work should be so noted.

1.1 Function Name

Name of Function

Day Ahead Market Operations across 3 Western Regional Transmission Organizations (RTOs)

1.2 Function ID

IECSA identification number of the function

M-4

1.3 Brief Description

Describe briefly the scope, objectives, and rationale of the Function.

As the electricity industry is deregulated, and as FERC defines more clearly what the market operation tariffs will encompass, three possible Regional Transmission Organizations (RTOs) in the Western Interconnection are developing seamless interfaces for Market Participants to submit energy schedules and ancillary service bids across these 3 RTOs. The 3 RTOs are California ISO (existing ISO handling the electricity market in California), RTO West (potential RTO of many northwestern utilities), and WestConnect (potential RTO of many southwestern utilities). These 3 RTOs are developing the requirements for the Western RTO functions.

1.4 Narrative

A complete narrative of the Function from a Domain Expert's point of view, describing what occurs when, why, how, and under what conditions. This will be a separate document, but will act as the basis for identifying the Steps in Section 2.

The following is a list of Western RTO functions related to Day Ahead market operations.

Only the listed functions with asterisks are represented in the diagrams and/or step-by-step descriptions in section 2.

1. Day Ahead Market
 - a. Auction/sale of FTRs *
 - b. Day Ahead Submittal of Energy Schedules *
 - c. Day Ahead Submittal of Ancillary Service Bids *
 - d. Schedule Adjustment of Energy Schedules *
 - e. Schedule Adjustment of Ancillary Services *
 - f. NERC Tagging Management *

1.5 Actor (Stakeholder) Roles

Describe all the people (their job), systems, databases, organizations, and devices involved in or affected by the Function (e.g. operators, system administrators, technicians, end users, service personnel, executives, SCADA system, real-time database, RTO, RTU, IED, power system). Typically, these actors are logically grouped by organization or functional boundaries or just for collaboration purpose of this use case. We need to identify these groupings and their relevant roles and understand the constituency. The same actor could play different roles in different Functions, but only one role in one Function. If the same actor (e.g. the same person) does play multiple roles in one Function, list these different actor-roles as separate rows.

<i>Grouping (Community)'</i>		<i>Group Description</i>
<i>Market Operations</i>		
<i>Actor Name</i>	<i>Actor Type (person, device, system etc.)</i>	<i>Actor Description</i>
Area & ResourceOperation Centers	Corporation	
AuditingPersonnel	Person	
DatabaseAdministrator	Person	
DisCos	Corporation	
DistributionSystem	System	
Eligible Customer Metered Entity	Person	
Eligible Customers	Person	
GenCos	Corporation	
IntervalMeterDevice	Device	
LGROwner	Person	
LoadProfile	Database	
MarketParticipant	Person	
Metered Entities	Corporation	
WeatherService	Corporation	
NERC	Corporation	

<i>Grouping (Community)'</i>		<i>Group Description</i>
<i>Market Operations</i>		
<i>Actor Name</i>	<i>Actor Type (person, device, system etc.)</i>	<i>Actor Description</i>
Other 2 RTOs	Corporation	
RetailCos	Corporation	
RTOOperator	Person	
RTOProgrammerEngineerPersonnel	Person	
RTOScheduler	Person	
SC-FTROwner	Person	
SchedulingCoordinator	Person	
SettlementAdministrator	Person	
SettlementDataMgmtAgent	Corporation	
CustomerMeterDevice	Device	
Tag Authority	Corporation	
TimeLineManager	Timer	
TransmissionOwner	Person	
TransmissionSystem	Power System	
WSCC	Corporation	

<i>Grouping (Community)'</i>		<i>Group Description</i>
<i>Market Operations</i>		
<i>Actor Name</i>	<i>Actor Type (person, device, system etc.)</i>	<i>Actor Description</i>
PowerSystemModel	Database	
RTOPowerSystemModelPowerSystemModel	Database	
TransmissionOutageSchedule	Database	
LGRGenerationMaintenanceSchedule	Database	
EnergyScheduleDatabase	Database	
AncillaryServiceSchedule	Database	
TransmissionRightOwnershipDatabase	Database	
FTR Requirements Matrix	Database	
TransmissionSystemCharacteristicsDatabase	Database	
Existing Transmission Contracts	Database	
OperatingPlan	Database	
Balancing Energy Stack	Database	
Ancillary Services Procurement Analysis		

<i>Grouping (Community)'</i>		<i>Group Description</i>
<i>Market Operations</i>		
<i>Actor Name</i>	<i>Actor Type (person, device, system etc.)</i>	<i>Actor Description</i>
Area & Resource Operation Centers		
CongestionManagementSystem		
Control (DAC) Subsystem		
Data Acquisition		
FTR Market Clearing Price Auction Function		
OperationalTransmissionCapacity		
Tag Approval Service		
WMI Web Server		

Replicate this table for each logic group.

1.6 Information Exchanged

Describe any information exchanged in this template.

<i>Information Object Name</i>	<i>Information Object Description</i>

1.7 Activities/Services

Describe or list the activities and services involved in this Function (in the context of this Function). An activity or service can be provided by a computer system, a set of applications, or manual procedures. These activities/services should be described at an appropriate level, with the understanding that sub-activities and services should be described if they are important for operational issues, automation needs, and implementation reasons. Other sub-activities/services could be left for later analysis.

<i>Activity/Service Name</i>	<i>Activities/Services Provided</i>
Maintenance Outage Function	Analyzes maintenance outages
7-Day Load Forecast Function	Determines the long term load forecast
CongestionManagementSystem	Determines if congestion could occur
Operations Transmission Capacity	Determines the Operations Transmission Capacity, based on energy schedules
Western Market Interface Web Server	Manages the interface between the RTOs and the MarketParticipants
Data Acquisition and Control Subsystem	Monitors and controls field devices
Available FTR	Manages FTRs
FTR Market Clearing Price Auction Function	Determines market clearing price of FTRs based on energy schedules
EnergyScheduleDatabase Analysis Function	Analyzes the energy schedules
Ancillary Services Procurement Analysis	Analyzes the needs for ancillary services
Tag Approval Service	Approves electronic tags

1.8 Contracts/Regulations

Identify any overall (human-initiated) contracts, regulations, policies, financial considerations, engineering constraints, pollution constraints, and other environmental quality issues that affect the design and requirements of the Function.

<i>Contract/Regulation</i>	<i>Impact of Contract/Regulation on Function</i>
Market Tariff	Basis for all actions

<i>Policy</i>	<i>From Actor</i>	<i>May</i>	<i>Shall Not</i>	<i>Shall</i>	<i>Description (verb)</i>	<i>To Actor</i>

<i>Constraint</i>	<i>Type</i>	<i>Description</i>	<i>Applies to</i>

2 Step by Step Analysis of Function

Describe steps that implement the function. If there is more than one set of steps that are relevant, make a copy of the following section grouping (Preconditions and Assumptions, Steps normal sequence, and Steps alternate or exceptional sequence, Post conditions)

2.1 Day Ahead Auction of FTRs and NCRs (DAAFN)

2.1.1 DAAFN – Preconditions and Assumptions

Describe conditions that must exist prior to the initiation of the Function, such as prior state of the actors and activities

Identify any assumptions, such as what systems already exist, what contractual relations exist, and what configurations of systems are probably in place

Identify any initial states of information exchanged in the steps in the next section. For example, if a purchase order is exchanged in an activity, its precondition to the activity might be 'filled in but unapproved'.

<i>Actor/System/Information/Contract</i>	<i>Preconditions or Assumptions</i>
All	Market operations are functioning according to the Market Tariff

2.1.2 DAAFN – Steps – Normal Sequence

#	Event	Primary Actor	Name of Process/Activity	Description of Process/Activity	Information Producer	Information Receiver	Name of Info Exchanged	Additional Notes	IECSA Environments
									Reference the applicable IECSA Environment containing this data exchange. Only one environment per step.
1.1	Before Day Ahead market	SchedulingCoordinator	Issue notice of intent	(1) Issue notice of intent to use FTRs and NCRs before Day Ahead market	SchedulingCoordinator	WMI Web Server	FTR Notices of intent		User Interface
1.2	After previous step	WMI Web Server	Update intents	(2) Update intents to use FTRs	WMI Web Server	TransmissionRightOwnershipDatabase	FTR Notices of intent		RTOs / Market Participants
1.3	After previous step	TransmissionRightOwnershipDatabase	(3) Provide updates on un-used FTRs and NCRs	(3) Provide updates on un-used FTRs and NCRs	TransmissionRightOwnershipDatabase	OperationalTransmissionCapacity	Unused FTRs		RTOs / Market Participants
1.4	After previous step	TimeLineManager	(4) Trigger posting of FTRs at Schedule Close	(4) Trigger posting of FTRs at Schedule Close	TimeLineManager	OperationalTransmissionCapacity	Used FTRs		RTOs / Market Participants
1.5	After previous step	OperationalTransmissionCapacity	(5) Post available FTRs as auctionable RTRs	(5) Post available FTRs as auctionable RTRs	OperationalTransmissionCapacity	WMI Web Server	Available FTRs		RTOs / Market Participants
1.6	After previous step	WMI Web Server	(6) Review auctionable RTRs	(6) Review auctionable RTRs	WMI Web Server	SchedulingCoordinator	Auctionable RTRs		RTOs / Market Participants

#	Event	Primary Actor	Name of Process/Activity	Description of Process/Activity	Information Producer	Information Receiver	Name of Info Exchanged	Additional Notes	IECSA Environments
1.7	After previous step	SchedulingCoordinator	(7) Make one-time bid on RTRs and ancillary services	(7) Make one-time bid on RTRs and ancillary services	SchedulingCoordinator	WMI Web Server	Bids for RTRs		User Interface
1.8	After previous step	WMI Web Server	(8) Enter RTR bids	(8) Enter RTR bids	WMI Web Server	FTR Market Clearing Price Auction Function	Bids for RTRs		RTOs / Market Participants
1.9	After previous step	FTR Market Clearing Price Auction Function	(9) Select highest bidder for RTR and store as RTR owner	(9) Select highest bidder for RTR and store as RTR owner	FTR Market Clearing Price Auction Function	TransmissionRightOwnershipDatabase	RTR ownership		RTOs / Market Participants
1.10	After previous step	WMI Web Server	(10) Notify of auction results	(10) Notify of auction results	WMI Web Server	SchedulingCoordinator	Auction results		User Interface

2.1.3 DAAFN – Steps – Alternative / Exception Sequences

Describe any alternative or exception sequences that may be required that deviate from the normal course of activities. Note instructions are found in previous table.

#	Event	Primary Actor	Name of Process/Activity	Description of Process/Activity	Information Producer	Information Receiver	Name of Info Exchanged	Additional Notes	IECSA Environments

2.1.4 DAAFN – Post-conditions and Significant Results

Describe conditions that must exist at the conclusion of the Function. Identify significant items similar to that in the preconditions section.

Describe any significant results from the Function

<i>Actor/Activity</i>	<i>Post-conditions Description and Results</i>

2.1.5 DAAFN – Architectural Issues in Interactions

Elaborate on all architectural issues in each of the steps outlined in each of the sequences above. Reference the Step by number..

2.1.6 DAAFN – Current Implementation Status

Describe briefly the current implementation status of the function and/or parts of it, referring to Steps above

Identify the key existing products, standards and technologies

<i>Product/Standard/Technology</i> Eg. DNP 3	<i>Ref - Usage</i> 2.1.2.1[1] - Exchange of SCADA information

Current Implementations:

<i>Relative maturity of function across industry:</i>	<i>Ref - Status Discussion</i>
Very mature and widely implemented	
Moderately mature	
Fairly new	Fairly new
Future, no systems, no interactions	

<i>Existence of legacy systems involved in function:</i>	<i>Ref - Status Discussion</i>
Many legacy systems	
Some legacy systems	
Few legacy systems	Very few legacy systems
No legacy systems	
Extensive changes will be needed for full functionality	
Moderate changes will be needed	
Few changes will be needed	
No changes will be needed	

<i>Implementation Concerns</i>	<i>Ref - Status Discussion</i>
Data availability and accuracy	
Known and unknown market pressures	Could have market pressures changing functionality
Known and unknown technology opportunities	

Validation of capabilities of function
--

Cost vs. benefit

2.1.7 DAAFN – Diagram

For clarification, draw (by hand, by Power Point, by UML diagram) the interactions, identifying the Steps where possible.

Day Ahead Auction of Available FTRs and NCRs

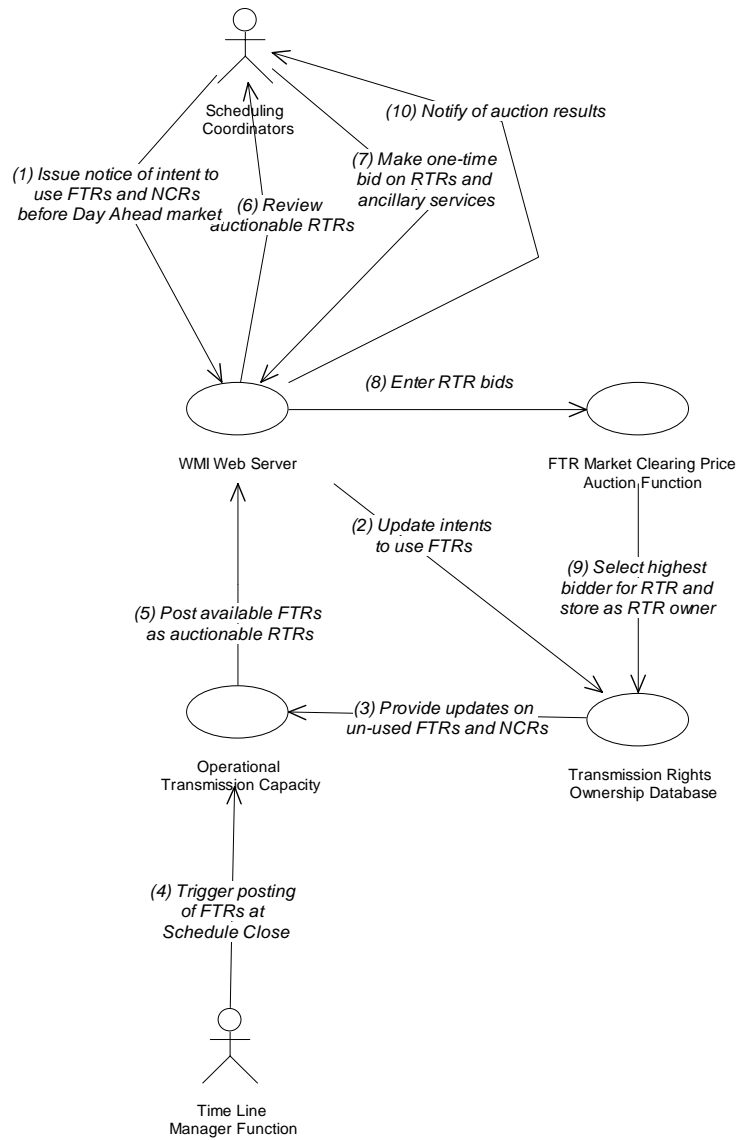

2.2 Day Ahead Submittal of Energy Schedules (DAES)

2.2.1 DAES – Preconditions and Assumptions

Describe conditions that must exist prior to the initiation of the Function, such as prior state of the actors and activities

Identify any assumptions, such as what systems already exist, what contractual relations exist, and what configurations of systems are probably in place

Identify any initial states of information exchanged in the steps in the next section. For example, if a purchase order is exchanged in an activity, its precondition to the activity might be 'filled in but unapproved'.

<i>Actor/System/Information/Contract</i>	<i>Preconditions or Assumptions</i>

2.2.2 DAES – Steps – Normal Sequence

#	Event	Primary Actor	Name of Process/Activity	Description of Process/Activity	Information Producer	Information Receiver	Name of Info Exchanged	Additional Notes	IECSA Environments
									<i>Reference the applicable IECSA Environment containing this data exchange. Only one environment per step.</i>
2.1	On-going	SchedulingCoordinator	Submit energy schedules	(1) Submit Balanced EnergyScheduleDatabase, including self-provided AncillaryServiceSchedule, any inter-SC trades, and any generation limit changes, until Schedule Close	SchedulingCoordinator	WMI Web Server	Energy schedules		User Interface
2.2	Submittal of an energy schedule	WMI Web Server	Validation	(2) Indicates valid input or indicates clerical & format errors	WMI Web Server	SchedulingCoordinator	Energy schedules		User Interface
2.3	Correction	SchedulingCoordinator	Correction	(3) Corrects errors	SchedulingCoordinator	WMI Web Server	Energy schedules		User Interface
2.4a	Valid energy schedule submitted	WMI Web Server	Energy Schedule Analysis	(4a) Provides Day-Ahead EnergyScheduleDatabase	WMI Web Server	Energy Schedule Analysis	Energy schedules		RTOs / Market Participants
2.4b	Simultaneous with previous step	WMI Web Server	EnergyScheduleDatabase to RTOs	(4b) Provides Day-Ahead EnergyScheduleDatabase relevant to each RTO	WMI Web Server	Other 2 RTOs Energy Schedule Processing	Energy schedules		RTOs / Market Participants

#	Event	Primary Actor	Name of Process/Activity	Description of Process/Activity	Information Producer	Information Receiver	Name of Info Exchanged	Additional Notes	IECSA Environments
2.5a	Analysis of energy schedules	Energy Schedule Analysis	Adjustment to energy schedules	(5a) Adjusts any unbalanced schedules and stores validated input as proposed schedules	Energy Schedule Analysis	RTO Energy & A/S Schedules	Energy schedules		RTOs / Market Participants
2.5b	Simultaneous with previous step	Energy Schedule Analysis	Adjusted energy Schedules to RTOs	(5b) Provides adjusted and validated cross-RTO schedules	Energy Schedule Analysis	Other 2 RTOs Energy Schedule Processing	Energy schedules		RTOs / Market Participants
2.5c	Simultaneous with previous step	Existing Transmission Contracts	Apply existing energy schedule contracts	(5c) Enter existing contracts	Existing Transmission Contracts	RTO Energy & A/S Schedules	Existing energy schedule contracts		RTOs / Market Participants
2.6a	Day Ahead Market Close	TimeLineManager	Time-based trigger	(6a) Initiates Day Ahead security analysis verification after Schedule Close	TimeLineManager	CongestionManagementSystem	Day Ahead Energy schedules		RTOs / Market Participants
2.6b	Simultaneous with previous step	RTO Energy & A/S Schedules	Retrieve Day-Ahead schedules	(6b) Retrieves all Day Ahead schedules	RTO Energy & A/S Schedules	CongestionManagementSystem	Day Ahead Energy schedules		RTOs / Market Participants
2.6c	Simultaneous with previous step	Other 2 RTOs Energy Schedule Processing	Cross-RTO security analysis	(6c) For cross-RTO schedules, validates schedules, adjusts any unbalanced schedules, and provides as proposed schedules	Other 2 RTOs Energy Schedule Processing	RTO Energy & A/S Schedules	Day Ahead Energy schedules		RTOs / Market Participants

#	Event	Primary Actor	Name of Process/Activity	Description of Process/Activity	Information Producer	Information Receiver	Name of Info Exchanged	Additional Notes	IECSA Environments
2.7a	After previous step	CongestionManagementSystem	Security Analysis	(7a) Verifies schedules meet intra-zonal & connection point security requirements	CongestionManagementSystem	RTO Energy & A/S Schedules	Day Ahead Energy schedules		RTOs / Market Participants
2.7b	Simultaneous with previous step	CongestionManagementSystem	Cross-RTO security analysis	(7b) For cross-RTO schedules, provide results of Congestion Management analysis	CongestionManagementSystem	Other 2 RTOs Energy Schedule Processing	Day Ahead Energy schedules		RTOs / Market Participants
2.8a	After previous step	RTO Energy & A/S Schedules	Post results of security analysis	(8a) Posts results of Congestion Management analysis of schedules	RTO Energy & A/S Schedules	WMI Web Server	Day Ahead Energy schedules		RTOs / Market Participants
2.8b	Simultaneous with previous step	Other 2 RTOs Energy Schedule Processing	Post results of cross-RTO security analysis	(8b) Posts results of Congestion Management analysis of cross-RTO schedules	Other 2 RTOs Energy Schedule Processing	WMI Web Server	Day Ahead Energy schedules		RTOs / Market Participants
2.8c	Simultaneous with previous step	Other 2 RTOs Energy Schedule Processing	Cross-RTO conflicts	(8c) Notify of cross-RTO conflicts or inconsistencies	Other 2 RTOs Energy Schedule Processing	RTOScheduler	Cross-RTO conflicts		RTOs / Market Participants
2.9	After step 8c	RTOScheduler	Resolve cross-RTO conflicts	(9) Posts resolutions to cross-RTO conflicts and inconsistencies	RTOScheduler	WMI Web Server	Resolved cross-RTO conflicts		User Interface
2.10	After previous step	WMI Web Server	Notify SchedulingCoordinator	(10) Notifies of schedule acceptances and rejections	WMI Web Server	SchedulingCoordinator	Accepted Energy schedules		User Interface

#	Event	Primary Actor	Name of Process/Activity	Description of Process/Activity	Information Producer	Information Receiver	Name of Info Exchanged	Additional Notes	IECSA Environments
2.11	Upon request by SchedulingCoordinator	SchedulingCoordinator	Revisions to energy schedules	(11) Enter revisions to schedules as needed, until Revision Close	SchedulingCoordinator	WMI Web Server	Revised energy schedules		User Interface

2.2.3 DAES – Steps – Alternative / Exception Sequences

Describe any alternative or exception sequences that may be required that deviate from the normal course of activities. Note instructions are found in previous table.

#	Event	Primary Actor	Name of Process/Activity	Description of Process/Activity	Information Producer	Information Receiver	Name of Info Exchanged	Additional Notes	IECSA Environments

2.2.4 DAES – Post-conditions and Significant Results

Describe conditions that must exist at the conclusion of the Function. Identify significant items similar to that in the preconditions section.

Describe any significant results from the Function

<i>Actor/Activity</i>	<i>Post-conditions Description and Results</i>

2.2.5 DAES – Architectural Issues in Interactions

Elaborate on all architectural issues in each of the steps outlined in each of the sequences above. Reference the Step by number. Double click on the embedded excel file – record the changes and save the excel file (this updates the embedded attachment).

2.2.6 DAES – Current Implementation Status

Describe briefly the current implementation status of the function and/or parts of it, referring to Steps above
Identify the key existing products, standards and technologies

<i>Product/Standard/Technology</i> Eg. DNP 3	<i>Ref - Usage</i> 2.1.2.1[1] - Exchange of SCADA information

Current Implementations:

<i>Relative maturity of function across industry:</i>	<i>Ref - Status Discussion</i>
Very mature and widely implemented	
Moderately mature	
Fairly new	Fairly new
Future, no systems, no interactions	

<i>Existence of legacy systems involved in function:</i>	<i>Ref - Status Discussion</i>
Many legacy systems	
Some legacy systems	
Few legacy systems	Very few legacy systems
No legacy systems	
Extensive changes will be needed for full functionality	
Moderate changes will be needed	
Few changes will be needed	
No changes will be needed	

<i>Implementation Concerns</i>	<i>Ref - Status Discussion</i>
Data availability and accuracy	
Known and unknown market pressures	Could have market pressures changing functionality
Known and unknown technology opportunities	
Validation of capabilities of function	
Cost vs. benefit	

2.2.7 DAES – Diagram

For clarification, draw (by hand, by Power Point, by UML diagram) the interactions, identifying the Steps where possible.

Day Ahead SCs Submittal of Balanced Energy Schedules - Business Processes

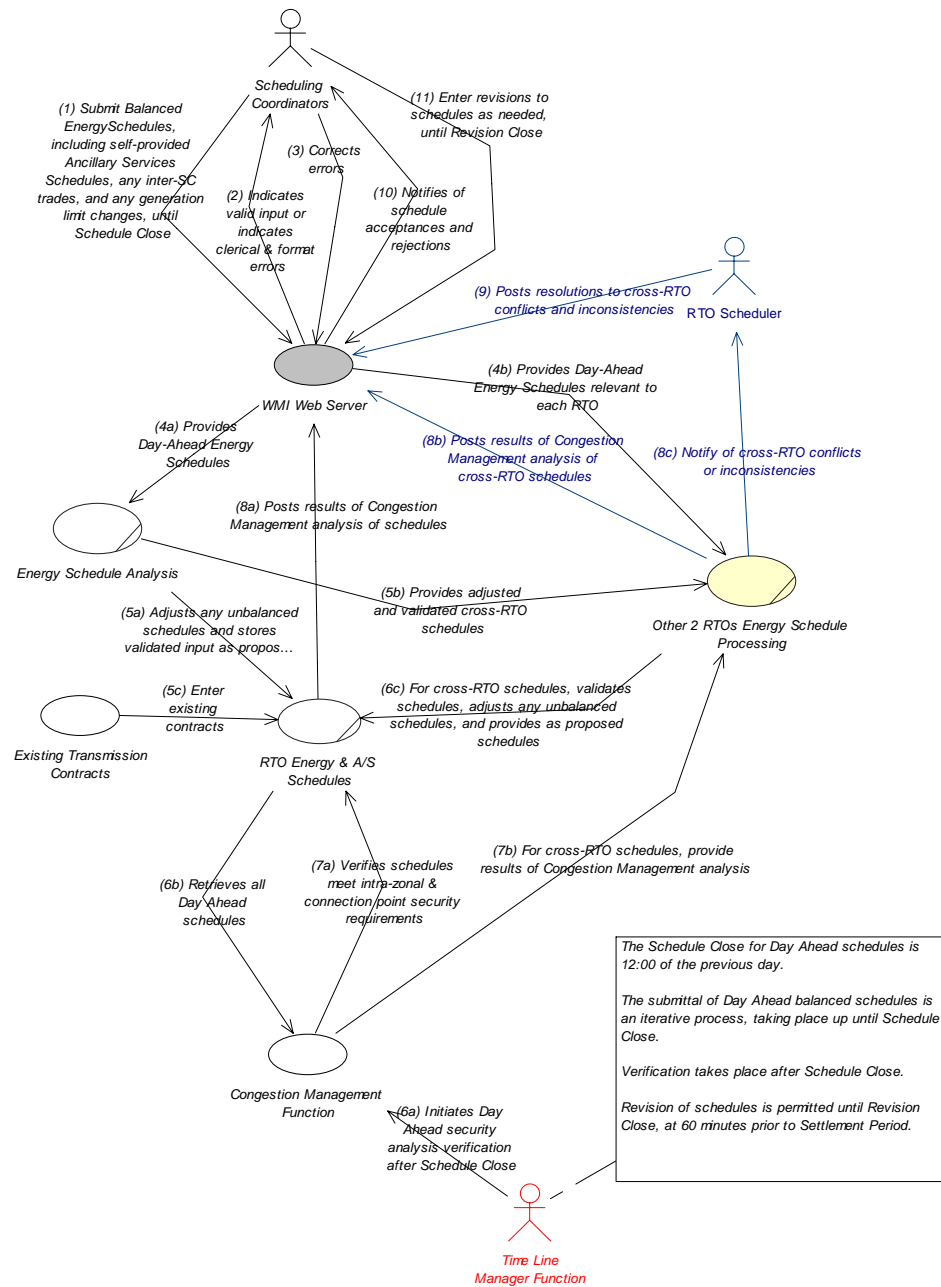

2.3 Day Ahead Submittal of Ancillary Services Bids (DAAS)

2.3.1 DAAS – Preconditions and Assumptions

Describe conditions that must exist prior to the initiation of the Function, such as prior state of the actors and activities

Identify any assumptions, such as what systems already exist, what contractual relations exist, and what configurations of systems are probably in place

Identify any initial states of information exchanged in the steps in the next section. For example, if a purchase order is exchanged in an activity, its precondition to the activity might be 'filled in but unapproved'.

<i>Actor/System/Information/Contract</i>	<i>Preconditions or Assumptions</i>

2.3.2 DAAS – Steps – Normal Sequence

#	Event	Primary Actor	Name of Process/Activity	Description of Process/Activity	Information Producer	Information Receiver	Name of Info Exchanged	Additional Notes	IECSA Environments
									<i>Reference the applicable IECSA Environment containing this data exchange. Only one environment per step.</i>
3.1	On-going	SchedulingCoordinator	Submit ancillary services bids	(1) Submit Ancillary Services resources and bid prices, until Schedule Close	SchedulingCoordinator	WMI Web Server	Ancillary services bids		User Interface
3.2	Upon receipt of submittal	WMI Web Server	Validation of A/S bids	(2) Indicates valid input or indicates clerical & format errors	WMI Web Server	SchedulingCoordinator	Validity checks on ancillary services bids		User Interface
3.3	Correction of errors	SchedulingCoordinator	Corrections of A/S bids	(3) Correct errors	SchedulingCoordinator	WMI Web Server	Corrections to ancillary services resources and bid prices		User Interface
3.4a	Enter A/S	WMI Web Server	Enter A/S bids	(4a) Enter A/S resources and bid prices	WMI Web Server	RTO Energy & A/S Schedules	Ancillary services bids		User Interface
3.4b	Notify other RTOs	Other 2 RTOs	Notify other RTOs	(4b) Notify of A/S services accepted by other RTOs	Other 2 RTOs	Ancillary Services Procurement Analysis	Ancillary services bids		RTOs / Market Participants
3.5	Day ahead market close	TimeLineManager	Analyze A/S bids	(5) Initiates Day Ahead A/S analysis at Schedule Close	TimeLineManager	Ancillary Services Procurement Analysis	Ancillary services bids		RTOs / Market Participants

#	Event	Primary Actor	Name of Process/Activity	Description of Process/Activity	Information Producer	Information Receiver	Name of Info Exchanged	Additional Notes	IECSA Environments
3.6	Previous step	Ancillary Services Procurement Analysis	Determine which A/S	(6) Determines which A/S are needed, and calculates either one Market Clearing Price or separate Market Clearing Prices for each Congestion Zone	Ancillary Services Procurement Analysis	RTO Energy & A/S Schedules	Selected A/S bids		RTOs / Market Participants
3.7a	Previous step	RTO Energy & A/S Schedules	Create Balancing Energy Stack	(7a) Creates the Balancing Energy Stack entries for each Settlement Period	RTO Energy & A/S Schedules	Balancing Energy Stack	Selected A/S bids		RTOs / Market Participants
3.7b	Simultaneous with previous step	RTO Energy & A/S Schedules	Post results	(7b) Posts results of selection of A/S resources and the Market Clearing Price	RTO Energy & A/S Schedules	WMI Web Server	Selected A/S bids		RTOs / Market Participants
3.7c	Simultaneous with previous step	RTO Energy & A/S Schedules	Inform other RTOs	(7c) Inform other RTOs of accepted A/S resources	RTO Energy & A/S Schedules	Other 2 RTOs	Selected A/S bids		RTOs / Market Participants
3.8	Previous step	WMI Web Server	Notify SchedulingCoordinator	(8) Notifies of A/S resource status	WMI Web Server	SchedulingCoordinator	Selected A/S bids		User Interface
3.9	Previous step	SchedulingCoordinator	Withdraw A/S	(9) Withdrawal of Ancillary Service resources not yet selected by DStar	SchedulingCoordinator	WMI Web Server	Withdrawn A/S bids		User Interface

2.3.3 DAAS – Steps – Alternative / Exception Sequences

Describe any alternative or exception sequences that may be required that deviate from the normal course of activities. Note instructions are found in previous table.

#	Event	Primary Actor	Name of Process/Activity	Description of Process/Activity	Information Producer	Information Receiver	Name of Info Exchanged	Additional Notes	IECSA Environments

2.3.4 DAAS – Post-conditions and Significant Results

Describe conditions that must exist at the conclusion of the Function. Identify significant items similar to that in the preconditions section.

Describe any significant results from the Function

Actor/Activity	Post-conditions Description and Results

2.3.5 DAAS – Architectural Issues in Interactions

Elaborate on all architectural issues in each of the steps outlined in each of the sequences above.

Reference the Step by number. Double click on the embedded excel file – record the changes and save the excel file (this updates the embedded attachment).

2.3.6 DAAS – Current Implementation Status

*Describe briefly the current implementation status of the function and/or parts of it, referring to Steps above
Identify the key existing products, standards and technologies*

<i>Product/Standard/Technology</i> Eg. DNP 3	<i>Ref - Usage</i> 2.1.2.1[1] - Exchange of SCADA information

Current Implementations:

<i>Relative maturity of function across industry:</i>	<i>Ref - Status Discussion</i>
Very mature and widely implemented	
Moderately mature	
Fairly new	Fairly new
Future, no systems, no interactions	

<i>Existence of legacy systems involved in function:</i>	<i>Ref - Status Discussion</i>
Many legacy systems	
Some legacy systems	
Few legacy systems	Very few legacy systems
No legacy systems	
Extensive changes will be needed for full functionality	
Moderate changes will be needed	

Few changes will be needed
No changes will be needed

<i>Implementation Concerns</i>	<i>Ref - Status Discussion</i>
Data availability and accuracy	
Known and unknown market pressures	Could have market pressures changing functionality
Known and unknown technology opportunities	
Validation of capabilities of function	
Cost vs. benefit	

2.3.7 DAAS – Diagram

For clarification, draw (by hand, by Power Point, by UML diagram) the interactions, identifying the Steps where possible.

Day Ahead SCs Submittal of Ancillary Services Bids (including LGRs) into the Auction Process

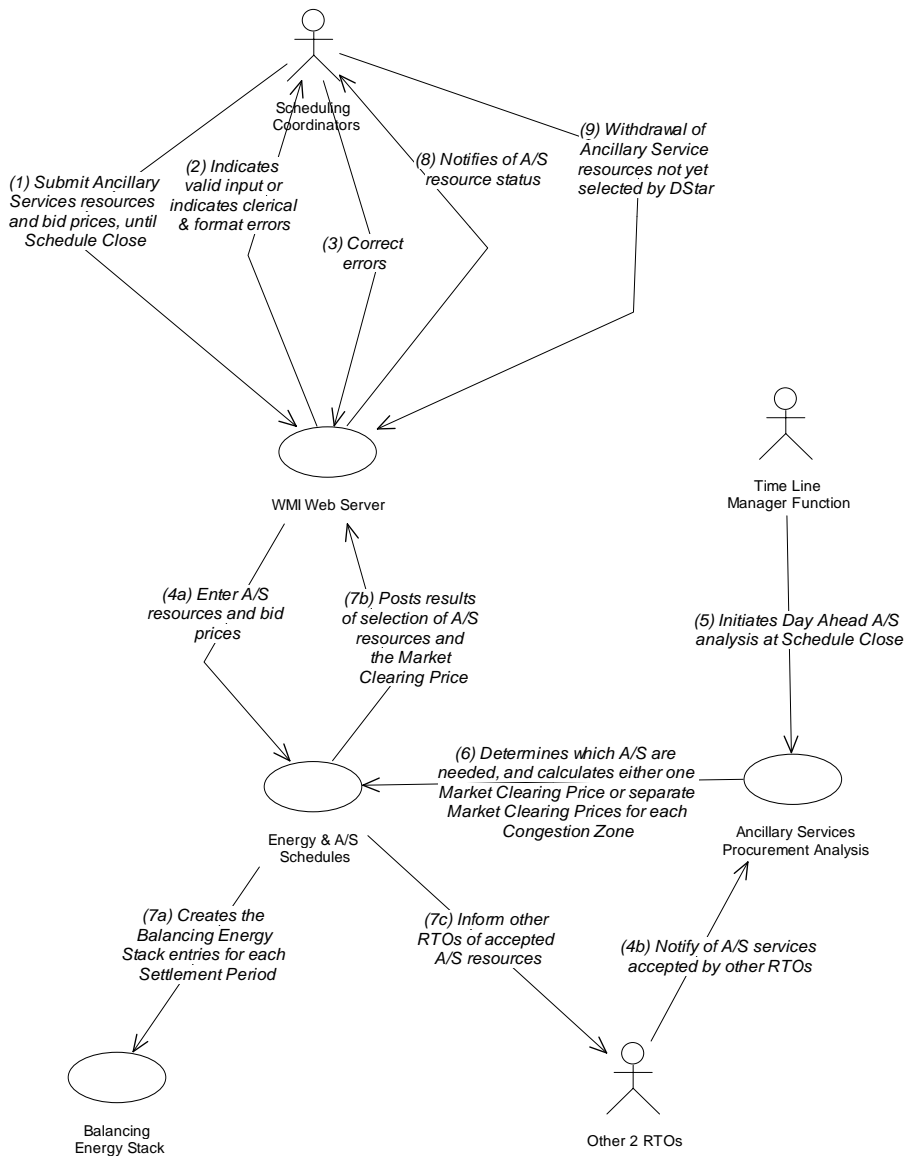

2.4 Adjust Energy Schedules (AES)

2.4.1 AES – Preconditions and Assumptions

Describe conditions that must exist prior to the initiation of the Function, such as prior state of the actors and activities

Identify any assumptions, such as what systems already exist, what contractual relations exist, and what configurations of systems are probably in place

Identify any initial states of information exchanged in the steps in the next section. For example, if a purchase order is exchanged in an activity, its precondition to the activity might be 'filled in but unapproved'.

<i>Actor/System/Information/Contract</i>	<i>Preconditions or Assumptions</i>

2.4.2 AES – Steps – Normal Sequence

#	Event	Primary Actor	Name of Process/Activity	Description of Process/Activity	Information Producer	Information Receiver	Name of Info Exchanged	Additional Notes	IECSA Environments
									<i>Reference the applicable IECSA Environment containing this data exchange. Only one environment per step.</i>
4.1a	Whenever energy schedules need to be adjusted	SchedulingCoordinator	Submit adjusted schedules	(1a) Submits adjusted schedules for withdrawn RTR and other reasons, during Schedule Adjustment Period	SchedulingCoordinator	WMI Web Server	Adjusted schedules		User Interface
4.1b	Whenever RTRs need to be recalled	SC-FTROwner	Recall RTR	(1b) Recalls RTR (up to 2 hrs before Settlement Period) and submits new schedule using FTR	SC-FTROwner	WMI Web Server	Recalled RTRs New schedule		User Interface
4.2a	After previous step	WMI Web Server	Validation	(2a) Indicates valid input or indicates clerical & format errors	WMI Web Server	SchedulingCoordinator	Validated data		User Interface
4.2b	After validation	WMI Web Server	Reverts RTRs	(2b) Reverts RTR to original owner as FTR	WMI Web Server	TransmissionRightOwnershipDatabase	RTR ownership		RTOs / Market Participants
4.3a	Errors are corrected	SchedulingCoordinator	Error correction	(3a) Correct errors	SchedulingCoordinator	WMI Web Server	Corrected data		User Interface

#	Event	Primary Actor	Name of Process/Activity	Description of Process/Activity	Information Producer	Information Receiver	Name of Info Exchanged	Additional Notes	IECSA Environment s
4.3b	After 2b	TransmissionRightOwnershipDatabase	Provide updated FTR	(3b) Provides FTR ownership information	TransmissionRightOwnershipDatabase	RTO Energy & A/S Schedules	FTR ownership data		RTOs / Market Participants
4.4	After 3	WMI Web Server	Store validated input	(4) Stores validated input as proposed schedules	WMI Web Server	RTO Energy & A/S Schedules	Validated input		RTOs / Market Participants
4.5	At specified date and time	TimeLineManager	Initiate security analysis	(5) Initiates security analysis as needed for adjusted schedules	TimeLineManager	CongestionManagementSystem	Energy schedules		RTOs / Market Participants
4.6	After previous step	CongestionManagementSystem	Test for congestion	(6) Verifies schedules meet intra-zonal & connection point security requirements	CongestionManagementSystem	RTO Energy & A/S Schedules	Energy schedules		RTOs / Market Participants
4.7	At specified date and time	RTO Energy & A/S Schedules	Post results	(7) Posts results of FTR ownership and security analysis of schedules	RTO Energy & A/S Schedules	WMI Web Server	Energy schedules		RTOs / Market Participants
4.8	After close of schedule adjustment period	RTO Energy & A/S Schedules	Update operating plan	(8) Updates OperatingPlan after close of Schedule Adjustment period	RTO Energy & A/S Schedules	OperatingPlan	Energy schedules and A/S schedules		RTOs / Market Participants
4.9a	One hour before Settlement Period	OperatingPlan	Review OperatingPlan	(9a) Reviews Final OperatingPlan one hour ahead of Settlement Period	OperatingPlan database	Area & Resource Operation Centers	OperatingPlan		RTOs / Market Participants

#	Event	Primary Actor	Name of Process/Activity	Description of Process/Activity	Information Producer	Information Receiver	Name of Info Exchanged	Additional Notes	IECSA Environment s
4.9b	One hour before Settlement Period	OperatingPlan	Review OperatingPlan	(9b) Reviews Final OperatingPlan one hour ahead of Settlement Period	OperatingPlan database	TransmissionOwner	OperatingPlan		RTOs / Market Participants
4.9c	One hour before Settlement Period	OperatingPlan	Provide OperatingPlan	(9c) Provides OperatingPlan to other RTOs	OperatingPlan database	Other 2 RTOs	OperatingPlan		RTOs / Market Participants
4.10a	After previous step	Area & Resource Operation Centers	Confirm OperatingPlan	(10a) Confirms OperatingPlan	Area & Resource Operation Centers	OperatingPlan database	OperatingPlan		RTOs / Market Participants
4.10b		TransmissionOwner	Confirm OperatingPlan	(10b) Confirms OperatingPlan	TransmissionOwner	OperatingPlan database	OperatingPlan		RTOs / Market Participants
4.11	At specific date and time	OperatingPlan database	Post OperatingPlan	(11) Posts public information of OperatingPlan	OperatingPlan database	WMI Web Server	OperatingPlan		RTOs / Market Participants

2.4.3 AES – Steps – Alternative / Exception Sequences

Describe any alternative or exception sequences that may be required that deviate from the normal course of activities. Note instructions are found in previous table.

#	Event	Primary Actor	Name of Process/Activity	Description of Process/Activity	Information Producer	Information Receiver	Name of Info Exchanged	Additional Notes	IECSA Environments

2.4.4 AES – Post-conditions and Significant Results

Describe conditions that must exist at the conclusion of the Function. Identify significant items similar to that in the preconditions section.

Describe any significant results from the Function

<i>Actor/Activity</i>	<i>Post-conditions Description and Results</i>

2.4.5 AES – Architectural Issues in Interactions

Elaborate on all architectural issues in each of the steps outlined in each of the sequences above.

Reference the Step by number. Double click on the embedded excel file – record the changes and save the excel file (this updates the embedded attachment).

2.4.6 AES – Current Implementation Status

Describe briefly the current implementation status of the function and/or parts of it, referring to Steps above
Identify the key existing products, standards and technologies

<i>Product/Standard/Technology</i> Eg. DNP 3	<i>Ref - Usage</i> 2.1.2.1[1] - Exchange of SCADA information

Current Implementations:

<i>Relative maturity of function across industry:</i>	<i>Ref - Status Discussion</i>
Very mature and widely implemented	
Moderately mature	
Fairly new	Fairly new
Future, no systems, no interactions	

<i>Existence of legacy systems involved in function:</i>	<i>Ref - Status Discussion</i>
Many legacy systems	
Some legacy systems	
Few legacy systems	Very few legacy systems
No legacy systems	
Extensive changes will be needed for full functionality	
Moderate changes will be needed	
Few changes will be needed	

No changes will be needed

<i>Implementation Concerns</i>	<i>Ref - Status Discussion</i>
Data availability and accuracy	
Known and unknown market pressures	Could have market pressures changing functionality
Known and unknown technology opportunities	
Validation of capabilities of function	
Cost vs. benefit	

2.4.7 AES – Diagram

For clarification, draw (by hand, by Power Point, by UML diagram) the interactions, identifying the Steps where possible.

Process for Energy Scheduling during the Schedule Adjustment Period

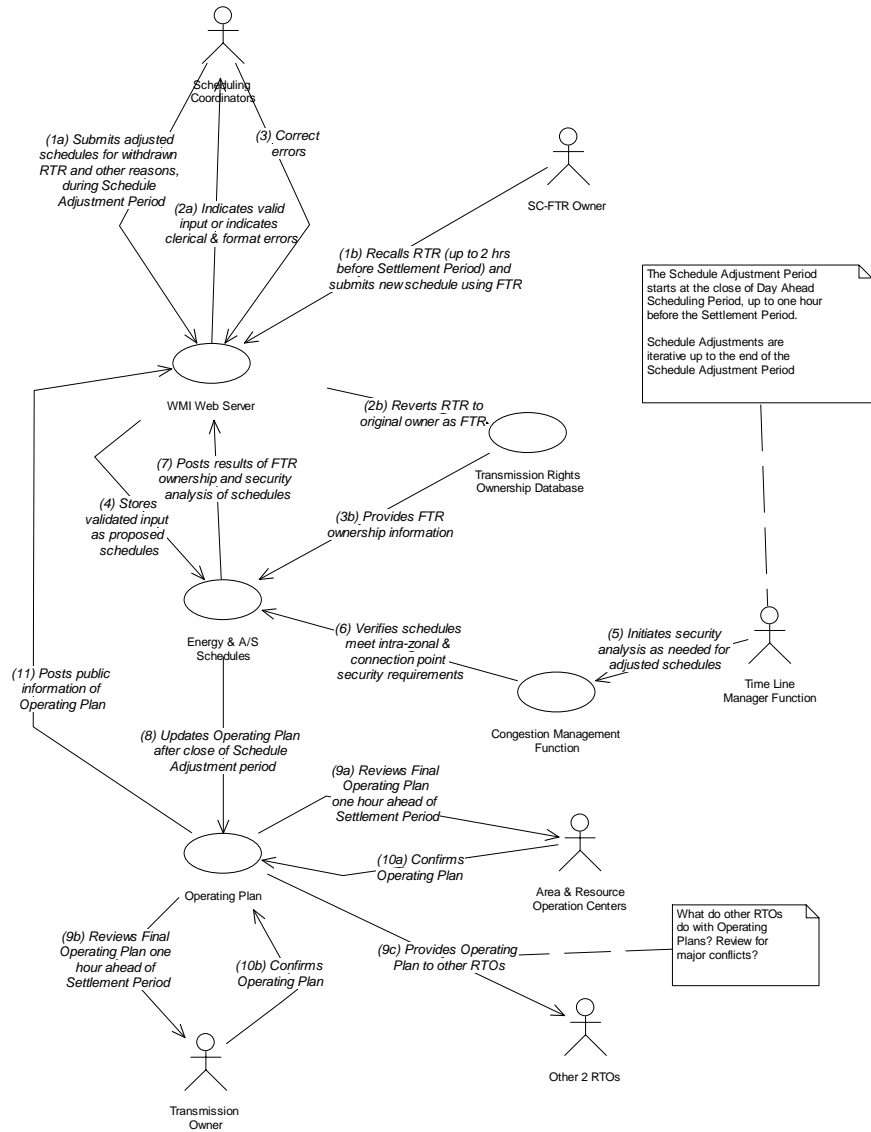

2.5 Adjust Ancillary Services (AAS)

2.5.1 AAS – Preconditions and Assumptions

Describe conditions that must exist prior to the initiation of the Function, such as prior state of the actors and activities

Identify any assumptions, such as what systems already exist, what contractual relations exist, and what configurations of systems are probably in place

Identify any initial states of information exchanged in the steps in the next section. For example, if a purchase order is exchanged in an activity, its precondition to the activity might be 'filled in but unapproved'.

<i>Actor/System/Information/Contract</i>	<i>Preconditions or Assumptions</i>

2.5.2 AAS – Steps – Normal Sequence

#	Event	Primary Actor	Name of Process/Activity	Description of Process/Activity	Information Producer	Information Receiver	Name of Info Exchanged	Additional Notes	IECSA Environments
									<i>Reference the applicable IECSA Environment containing this data exchange. Only one environment per step.</i>
5.1	Anytime up to 30 minutes before Settlement Period	SchedulingCoordinator	Submit one-time A/S bids	(1) Submittal of one-time Bids for Ancillary Services up to 30 minutes before Settlement Period	SchedulingCoordinator	WMI Web Server	A/S bids		User Interface
5.2	After previous step	WMI Web Server	Validate	(2) Indicates valid input or indicates clerical & format errors	WMI Web Server	SchedulingCoordinator	Error indications		User Interface
5.3	After previous step	SchedulingCoordinator	Correct errors	(3) Correct errors	SchedulingCoordinator	WMI Web Server	Corrected A/S bids		User Interface
5.4a	After previous step	WMI Web Server	Enter A/S bids	(4a) Enter A/S resources and bid prices	WMI Web Server	RTO Energy & A/S Schedules	A/S bids		RTOs / Market Participants
5.4b		Other 2 RTOs	Notify of accepted A/S bids	(4b) Notify of A/S services accepted by other RTOs	Other 2 RTOs	Ancillary Services Procurement Analysis	Accepted A/S bids		RTOs / Market Participants

#	Event	Primary Actor	Name of Process/Activity	Description of Process/Activity	Information Producer	Information Receiver	Name of Info Exchanged	Additional Notes	IECSA Environments
5.5a	After previous step	Data Acquisition and Control (DAC) Subsystem	Indicate possible need for A/S services	(5a) Indicate probable need for additional A/S resources	Data Acquisition and Control (DAC) Subsystem	Ancillary Services Procurement Analysis	Indication of need for A/S		RTOs / Market Participants
5.5b		Balancing Energy Stack	Indicate possible need for A/S services	(5b) Indicate probable need for additional A/S resources	Balancing Energy Stack	Ancillary Services Procurement Analysis	Indication of need for A/S		RTOs / Market Participants
5.6	After previous step	Ancillary Services Procurement Analysis	Determine needed A/S	(6) Determines need for additional A/S resources, and selects lowest bids	Ancillary Services Procurement Analysis	RTO Energy & A/S Schedules	Selected A/S schedules		RTOs / Market Participants
5.7a	After previous step	RTO Energy & A/S Schedules	Post	(7a) Posts selected A/S resources	RTO Energy & A/S Schedules	WMI Web Server	Selected A/S schedules		RTOs / Market Participants
5.7b		RTO Energy & A/S Schedules	Provide A/S	(7b) Provides selected A/S resources	RTO Energy & A/S Schedules	Balancing Energy Stack	Selected A/S schedules		RTOs / Market Participants
5.7c		RTO Energy & A/S Schedules	Inform RTOs	(7c) Inform other RTOs of selected A/S resources	RTO Energy & A/S Schedules	Other 2 RTOs	Selected A/S schedules		RTOs / Market Participants
5.8	After previous step	WMI Web Server	Notify	(8) Notifies of A/S resource status	WMI Web Server	SchedulingCoordinator	Selected A/S schedules		User Interface
5.9	Anytime after previous step	SchedulingCoordinator	Withdraw A/S	(9) Can withdraw Ancillary Service bids if not already selected by RTO	SchedulingCoordinator	WMI Web Server	Withdrawn A/S		User Interface

#	Event	Primary Actor	Name of Process/Activity	Description of Process/Activity	Information Producer	Information Receiver	Name of Info Exchanged	Additional Notes	IECSA Environments
5.10	After previous step	WMI Web Server	Notify	(10) Notify other RTOs of withdrawn A/S bids	WMI Web Server	Other 2 RTOs	Withdrawn A/S		RTOs / Market Participants

2.5.3 AAS – Steps – Alternative / Exception Sequences

Describe any alternative or exception sequences that may be required that deviate from the normal course of activities. Note instructions are found in previous table.

#	Event	Primary Actor	Name of Process/Activity	Description of Process/Activity	Information Producer	Information Receiver	Name of Info Exchanged	Additional Notes	IECSA Environments

2.5.4 AAS – Post-conditions and Significant Results

Describe conditions that must exist at the conclusion of the Function. Identify significant items similar to that in the preconditions section.

Describe any significant results from the Function

<i>Actor/Activity</i>	<i>Post-conditions Description and Results</i>

2.5.5 AAS – Architectural Issues in Interactions

Elaborate on all architectural issues in each of the steps outlined in each of the sequences above. Reference the Step by number. Double click on the embedded excel file – record the changes and save the excel file (this updates the embedded attachment).

2.5.6 AAS – Current Implementation Status

*Describe briefly the current implementation status of the function and/or parts of it, referring to Steps above
Identify the key existing products, standards and technologies*

<i>Product/Standard/Technology</i>	<i>Ref - Usage</i>
Eg. DNP 3	2.1.2.1[1] - Exchange of SCADA information

Current Implementations:

<i>Relative maturity of function across industry:</i>	<i>Ref - Status Discussion</i>
Very mature and widely implemented	
Moderately mature	
Fairly new	Fairly new
Future, no systems, no interactions	

<i>Existence of legacy systems involved in function:</i>	<i>Ref - Status Discussion</i>
Many legacy systems	
Some legacy systems	
Few legacy systems	Very few legacy systems
No legacy systems	
Extensive changes will be needed for full functionality	
Moderate changes will be needed	
Few changes will be needed	
No changes will be needed	

<i>Implementation Concerns</i>	<i>Ref - Status Discussion</i>
Data availability and accuracy	
Known and unknown market pressures	Could have market pressures changing functionality
Known and unknown technology opportunities	
Validation of capabilities of function	
Cost vs. benefit	

2.5.7 AAS – Diagram

For clarification, draw (by hand, by Power Point, by UML diagram) the interactions, identifying the Steps where possible.

Auction of Ancillary Services (including LGRs) during Schedule Adjustment Period

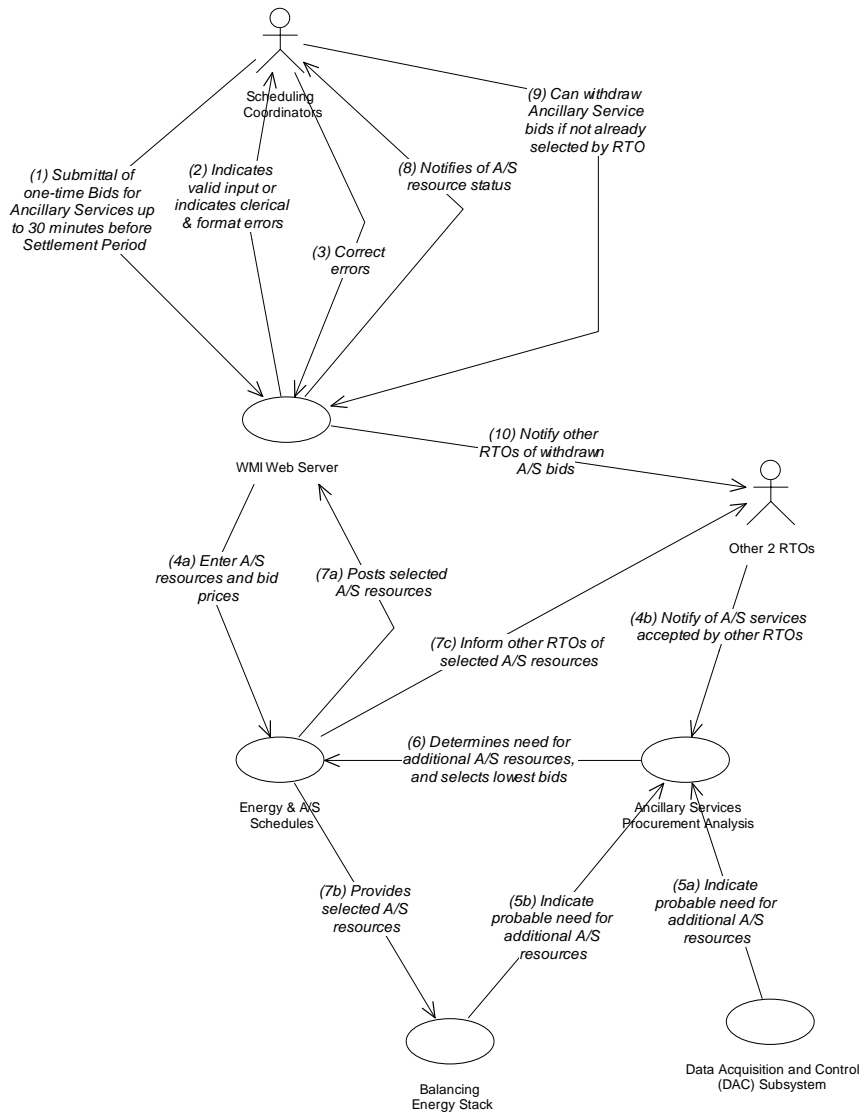

2.6 NERC E-Tagging Management (ETAG)

2.6.1 ETAG – Preconditions and Assumptions

Describe conditions that must exist prior to the initiation of the Function, such as prior state of the actors and activities

Identify any assumptions, such as what systems already exist, what contractual relations exist, and what configurations of systems are probably in place

Identify any initial states of information exchanged in the steps in the next section. For example, if a purchase order is exchanged in an activity, its precondition to the activity might be 'filled in but unapproved'.

<i>Actor/System/Information/Contract</i>	<i>Preconditions or Assumptions</i>

2.6.2 ETAG – Steps – Normal Sequence

#	Event	Primary Actor	Name of Process/Activity	Description of Process/Activity	Information Producer	Information Receiver	Name of Info Exchanged	Additional Notes	IECSA Environments
									<i>Reference the applicable IECSA Environment containing this data exchange. Only one environment per step.</i>
6.1	At appropriate times	Scheduling Coordinator	Submit tags	(1) Submit tags to Tag Authority	Scheduling Coordinator	Tag Authority	Etag information		User Interface
6.2	After previous step	Tag Authority	Submit tags	(2) Submit all tags requiring RTO approval	Tag Authority	WMI Web Server	Etag information		RTOs / Market Participants
6.3	After previous step	WMI Web Server	Submit tags	(3) Submit tags for validation and approval	WMI Web Server	Tag Approval Service	Etag information		RTOs / Market Participants
6.4	After previous step	RTO Energy & A/S Schedules	Provide approval status	(4) Provide approval status of energy schedules and ancillary services procurements	RTO Energy & A/S Schedules	Tag Approval Service	Etag information		RTOs / Market Participants
6.5	After previous step	Tag Approval Service	Provide approval status	(5) Indicate status of tags, based on status of energy and A/S schedules	Tag Approval Service	WMI Web Server	Etag information		RTOs / Market Participants
6.6	After previous step	WMI Web Server	Submit tags	(6) Send updated tag information	WMI Web Server	Tag Authority	Etag information		RTOs / Market Participants
6.7	After previous step	Tag Authority	Submit tags	(7) Submit tagging information to NERC	Tag Authority	NERC	Etag information		Inter-Corporation

2.6.3 ETAG – Steps – Alternative / Exception Sequences

Describe any alternative or exception sequences that may be required that deviate from the normal course of activities. Note instructions are found in previous table.

#	Event	Primary Actor	Name of Process/Activity	Description of Process/Activity	Information Producer	Information Receiver	Name of Info Exchanged	Additional Notes	IECSA Environments

2.6.4 ETAG – Post-conditions and Significant Results

Describe conditions that must exist at the conclusion of the Function. Identify significant items similar to that in the preconditions section.

Describe any significant results from the Function

Actor/Activity	Post-conditions Description and Results

2.6.5 ETAG – Architectural Issues in Interactions

Elaborate on all architectural issues in each of the steps outlined in each of the sequences above. Reference the Step by number. Double click on the embedded excel file – record the changes and save the excel file (this updates the embedded attachment).

2.6.6 ETAG – Current Implementation Status

Describe briefly the current implementation status of the function and/or parts of it, referring to Steps above
Identify the key existing products, standards and technologies

<i>Product/Standard/Technology</i> Eg. DNP 3	<i>Ref - Usage</i> 2.1.2.1[1] - Exchange of SCADA information

Current Implementations:

<i>Relative maturity of function across industry:</i>	<i>Ref - Status Discussion</i>
Very mature and widely implemented	
Moderately mature	
Fairly new	Fairly new
Future, no systems, no interactions	

<i>Existence of legacy systems involved in function:</i>	<i>Ref - Status Discussion</i>
Many legacy systems	
Some legacy systems	
Few legacy systems	Very few legacy systems
No legacy systems	

Extensive changes will be needed for full functionality
Moderate changes will be needed
Few changes will be needed
No changes will be needed

<i>Implementation Concerns</i>	<i>Ref - Status Discussion</i>
Data availability and accuracy	
Known and unknown market pressures	Could have market pressures changing functionality
Known and unknown technology opportunities	
Validation of capabilities of function	
Cost vs. benefit	

2.6.7 ETAG – Diagram

For clarification, draw (by hand, by Power Point, by UML diagram) the interactions, identifying the Steps where possible.

NERC Tagging Process

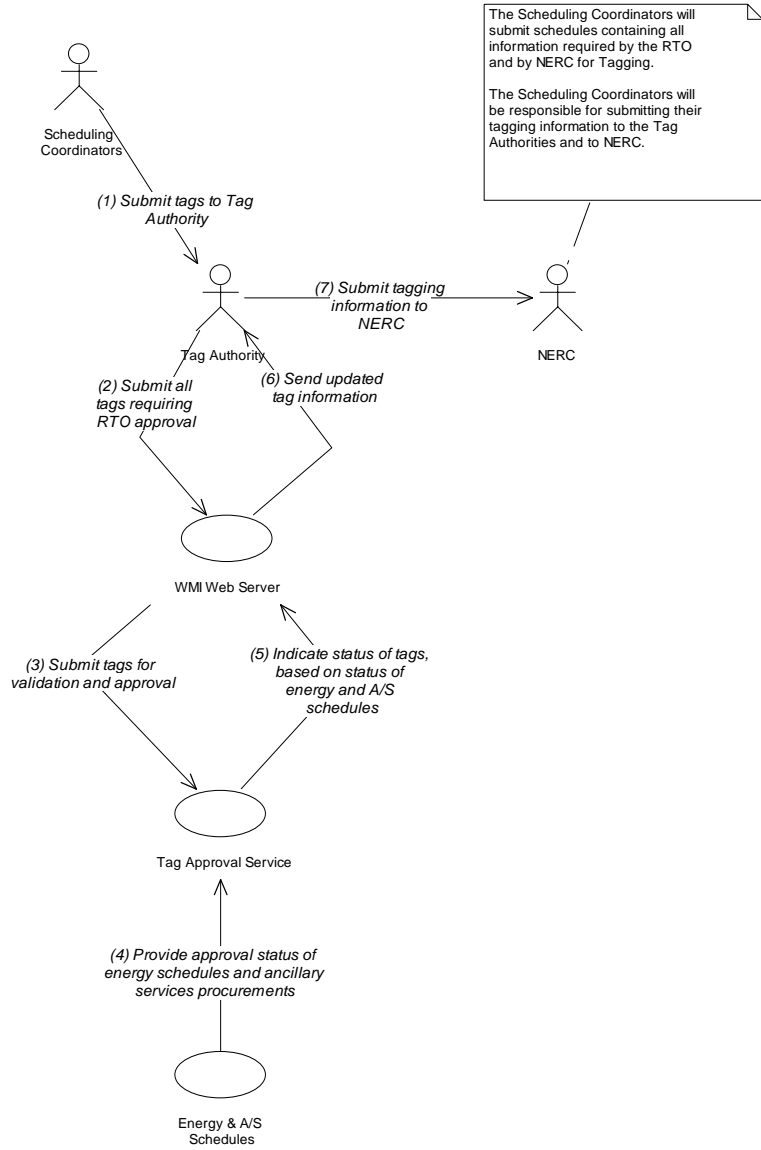

3 Auxiliary Issues

3.1 References and contacts

Documents and individuals or organizations used as background to the function described; other functions referenced by this function, or acting as “sub” functions; or other documentation that clarifies the requirements or activities described. All prior work (intellectual property of the company or individual) or proprietary (non-publicly available) work must be so noted.

ID	Title or contact	Reference or contact information
[1]		
[2]		

3.2 Action Item List

As the function is developed, identify issues that still need clarification, resolution, or other notice taken of them. This can act as an Action Item list.

ID	Description	Status
[1]		
[2]		

3.3 Revision History

For reference and tracking purposes, indicate who worked on describing this function, and what aspect they undertook.

No	Date	Author	Description
0.	Feb 27, 2004	Frances Cleveland	

This page intentionally left blank.

Market Operations – Long Term Planning

1 Descriptions of Functions – Long Term Planning for Market Operations

All prior work (intellectual property of the company or individual) or proprietary (non-publicly available) work should be so noted.

1.1 Function Name

Name of Function

Long Term Planning for Market Operations across 3 Western Regional Transmission Organizations (RTOs)

1.2 Function ID

IECSA identification number of the function

M-1.1, M-1.2

1.3 Brief Description

Describe briefly the scope, objectives, and rationale of the Function.

As the electricity industry is deregulated, and as FERC defines more clearly what the market operation tariffs will encompass, three possible Regional Transmission Organizations (RTOs) in the Western Interconnection are developing seamless interfaces for Market Participants to submit energy schedules and ancillary service bids across these 3 RTOs. The 3 RTOs are California ISO (existing ISO handling the electricity market in California), RTO West (potential RTO of many northwestern utilities), and WestConnect (potential RTO of many southwestern utilities). These 3 RTOs are developing the requirements for the Western RTO functions.

1.4 Narrative

A complete narrative of the Function from a Domain Expert's point of view, describing what occurs when, why, how, and under what conditions. This will be a separate document, but will act as the basis for identifying the Steps in Section 2.

The following is a list of Western RTO functions related to long term planning for market operations

Only the listed functions with asterisks are represented in the diagrams and/or step-by-step descriptions in section 2.

1. Long Term Planning
 - a. Registration of Market Participants
 - Credit rating of Market Participants
 - b. Capacity/Adequacy Market
 - c. Transmission and Generation Maintenance Coordination *
 - Establish transmission and generation standards and guidelines
 - Oversee ISO grid planning
 - d. Updating the Power System Model *
 - Register transmission data with WSCC EHV database
 - Perform WSCC path studies
 - Perform grid assessment
 - Perform new generation connection studies
 - Perform RMR studies
 - e. Generation certification

1.5 Actor (Stakeholder) Roles

Describe all the people (their job), systems, databases, organizations, and devices involved in or affected by the Function (e.g. operators, system administrators, technicians, end users, service personnel, executives, SCADA system, real-time database, RTO, RTU, IED, power system). Typically, these actors are logically grouped by organization or functional boundaries or just for collaboration purpose of this use case. We need to identify these groupings and their relevant roles and understand the constituency. The same actor could play different roles in different Functions, but only one role in one Function. If the same actor (e.g. the same person) does play multiple roles in one Function, list these different actor-roles as separate rows.

<i>Grouping (Community)'</i>		<i>Group Description</i>
<i>Market Operations</i>		
<i>Actor Name</i>	<i>Actor Type (person, device, system etc.)</i>	<i>Actor Description</i>
Area & Resource Operation Centers	Corporation	
AuditingPersonnel	Person	
DatabaseAdministrator	Person	
DisCos	Corporation	
DistributionSystem	System	
Eligible Customer Metered Entity	Person	
Eligible Customers	Person	
GenCos	Corporation	
IntervalMeterDevice	Device	
LGROwner	Person	
LoadProfile	Database	
MarketParticipant	Person	
Metered Entities	Corporation	
WeatherService	Corporation	
NERC	Corporation	

<i>Grouping (Community)'</i>		<i>Group Description</i>
<i>Market Operations</i>		
<i>Actor Name</i>	<i>Actor Type (person, device, system etc.)</i>	<i>Actor Description</i>
Other 2 RTOs	Corporation	
RetailCos	Corporation	
RTOOperator	Person	
RTOProgrammerEngineerPersonnel	Person	
RTOScheduler	Person	
SC-FTROwner	Person	
SchedulingCoordinator	Person	
SettlementAdministrator	Person	
SettlementDataMgmtAgent	Corporation	
CustomerMeterDevice	Device	
Tag Authority	Corporation	
TimeLineManager	Timer	
TransmissionOwner	Person	
TransmissionSystem	Power System	
WSCC	Corporation	

<i>Grouping (Community)'</i>		<i>Group Description</i>
<i>Market Operations</i>		
<i>Actor Name</i>	<i>Actor Type (person, device, system etc.)</i>	<i>Actor Description</i>
PowerSystemModel	Database	
RTOPowerSystemModelPowerSystemModel	Database	
TransmissionOutageSchedule	Database	
LGRGenerationMaintenanceSchedule	Database	
EnergyScheduleDatabase	Database	
Long Term Load Forecast		
Maintenance Outage Function		

Replicate this table for each logic group.

1.6 Information Exchanged

Describe any information exchanged in this template.

<i>Information Object Name</i>	<i>Information Object Description</i>

1.7 Activities/Services

Describe or list the activities and services involved in this Function (in the context of this Function). An activity or service can be provided by a computer system, a set of applications, or manual procedures. These activities/services should be described at an appropriate level, with the understanding that sub-activities and services should be described if they are important for operational issues, automation needs, and implementation reasons. Other sub-activities/services could be left for later analysis.

<i>Activity/Service Name</i>	<i>Activities/Services Provided</i>
Maintenance Outage Function	Analyzes maintenance outages
7-Day Load Forecast Function	Determines the long term load forecast
Western Market Interface Web Server	Manages the interface between the RTOs and the MarketParticipants

1.8 Contracts/Regulations

Identify any overall (human-initiated) contracts, regulations, policies, financial considerations, engineering constraints, pollution constraints, and other environmental quality issues that affect the design and requirements of the Function.

<i>Contract/Regulation</i>	<i>Impact of Contract/Regulation on Function</i>
Market Tariff	
Agreements between RTOs	

<i>Policy</i>	<i>From Actor</i>	<i>May</i>	<i>Shall Not</i>	<i>Shall</i>	<i>Description (verb)</i>	<i>To Actor</i>

<i>Constraint</i>	<i>Type</i>	<i>Description</i>	<i>Applies to</i>

2 Step by Step Analysis of Function

Describe steps that implement the function. If there is more than one set of steps that are relevant, make a copy of the following section grouping (Preconditions and Assumptions, Steps normal sequence, and Steps alternate or exceptional sequence, Post conditions)

2.1 Power System Model Update (PSMU)

Name of this sequence

2.1.1 PSMU – Preconditions and Assumptions

<i>Actor/System/Information/Contract</i>	<i>Preconditions or Assumptions</i>

2.1.2 PSMU – Steps – Normal Sequence

#	Event	Primary Actor	Name of Process/Activity	Description of Process/Activity	Information Producer	Information Receiver	Name of Info Exchanged	Additional Notes	IECSA Environments
									<i>Reference the applicable IECSA Environment containing this data exchange. Only one environment per step.</i>
1.1a	Periodically or as needed	TransmissionOwner	Update power system model	Provide updated transmission facilities model data and in-service dates	TransmissionOwner	PowerSystem Model	Transmission facilities		Inter-Control Center
1.1b	Periodically or as needed	GenCos	Update power system model	Provide updated generation facilities model data and in-service dates	GenCos	PowerSystem Model	Generation facilities		Inter-Control Center
1.1c	Periodically or as needed	DisCos	Update power system model	Provide updated connection point model data and in-service dates	DisCos	PowerSystem Model	Distribution facilities		Inter-Control Center
1.1d	Periodically or as needed	Eligible Customers	Update power system model	Provide updated connection point model data and in-service dates	Eligible Customers	PowerSystem Model	Customer facilities		Control Center / Corporations

² Note – A triggering event is not necessary if the completion of the prior step – leads to the transition of the following step.

#	Event	Primary Actor	Name of Process/Activity	Description of Process/Activity	Information Producer	Information Receiver	Name of Info Exchanged	Additional Notes	IECSA Environments
1.1e	Periodically or as needed	WSCC	Update power system model	Provide updated transmission facilities model data and in-service dates	WSCC	PowerSystem Model	WSCC transmission facilities		Inter-Control Center
1.1f	Periodically or as needed	RTOPowerSystemModelPowerSystemModels	Update power system model	Provide updated transmission facilities model data and in-service dates	RTOPowerSystemModelPowerSystemModels	PowerSystem Model	Other RTO transmission facilities		Inter-Control Center
1.2	Periodically or as needed	PowerSystem Model	Review updates	Review updates	PowerSystem Model	RTOProgrammerEngineerPersonnel	Updates		Intra-Control Center
1.3	After previous step	RTOProgrammerEngineerPersonnel	Review power model	Assure completeness and accuracy of updated model	RTOProgrammerEngineerPersonnel	PowerSystem Model	Power System model		Intra-Control Center
1.4a	After previous step	PowerSystem Model	Issue updated power system model	Issue updated power system model	PowerSystem Model	Eligible Customers	Power System model		Control Center / Corporations
1.4b	After previous step	PowerSystem Model	Issue updated power system model	Issue updated power system model	PowerSystem Model	DisCos	Power System model		Inter-Control Center
1.4c	After previous step	PowerSystem Model	Issue updated power system model	Issue updated power system model	PowerSystem Model	GenCos	Power System model		Inter-Control Center
1.4d	After previous step	PowerSystem Model	Issue updated power system model	Issue updated power system model	PowerSystem Model	TransmissionOwner	Power System model		Inter-Control Center
1.4e	After previous step	PowerSystem Model	Issue updated power system model	Issue updated power system model	PowerSystem Model	WSCC	Power System model		Inter-Control Center

#	Event	Primary Actor	Name of Process/Activity	Description of Process/Activity	Information Producer	Information Receiver	Name of Info Exchanged	Additional Notes	IECSA Environments
1.4f	After previous step	PowerSystem Model	Issue updated power system model	Issue updated power system model	PowerSystem Model	RTOPowerSystemModelPowerSystemModels	Power System model		Intra-Control Center

2.1.3 PSMU – Steps – Alternative / Exception Sequences

Describe any alternative or exception sequences that may be required that deviate from the normal course of activities. Note instructions are found in previous table.

#	Event	Primary Actor	Name of Process/Activity	Description of Process/Activity	Information Producer	Information Receiver	Name of Info Exchanged	Additional Notes	IECSA Environments

2.1.4 PSMU – Post-conditions and Significant Results

Describe conditions that must exist at the conclusion of the Function. Identify significant items similar to that in the preconditions section.

Describe any significant results from the Function

<i>Actor/Activity</i>	<i>Post-conditions Description and Results</i>

<i>Actor/Activity</i>	<i>Post-conditions Description and Results</i>

2.1.5 PSMU – Architectural Issues in Interactions

Elaborate on all architectural issues in each of the steps outlined in each of the sequences above. Reference the Step by number..

2.1.6 PSMU – Current Implementation Status

*Describe briefly the current implementation status of the function and/or parts of it, referring to Steps above
Identify the key existing products, standards and technologies*

<i>Product/Standard/Technology</i> Eg. DNP 3	<i>Ref - Usage</i> 2.1.2.1[1] - Exchange of SCADA information

Current Implementations:

<i>Relative maturity of function across industry:</i>	<i>Ref - Status Discussion</i>
Very mature and widely implemented	Very common application within utilities, but not necessarily large RTOs
Moderately mature	
Fairly new	

<i>Relative maturity of function across industry:</i>	<i>Ref - Status Discussion</i>
Future, no systems, no interactions	

<i>Existence of legacy systems involved in function:</i>	<i>Ref - Status Discussion</i>
Many legacy systems	
Some legacy systems	
Few legacy systems	
No legacy systems	
Extensive changes will be needed for full functionality	
Moderate changes will be needed	
Few changes will be needed	
No changes will be needed	

<i>Implementation Concerns</i>	<i>Ref - Status Discussion</i>
Data availability and accuracy	
Known and unknown market pressures	
Known and unknown technology opportunities	

Validation of capabilities of function
--

Cost vs. benefit

2.1.7 PSMU – Diagram

For clarification, draw (by hand, by Power Point, by UML diagram) the interactions, identifying the Steps where possible.

Power System Model Update Processes

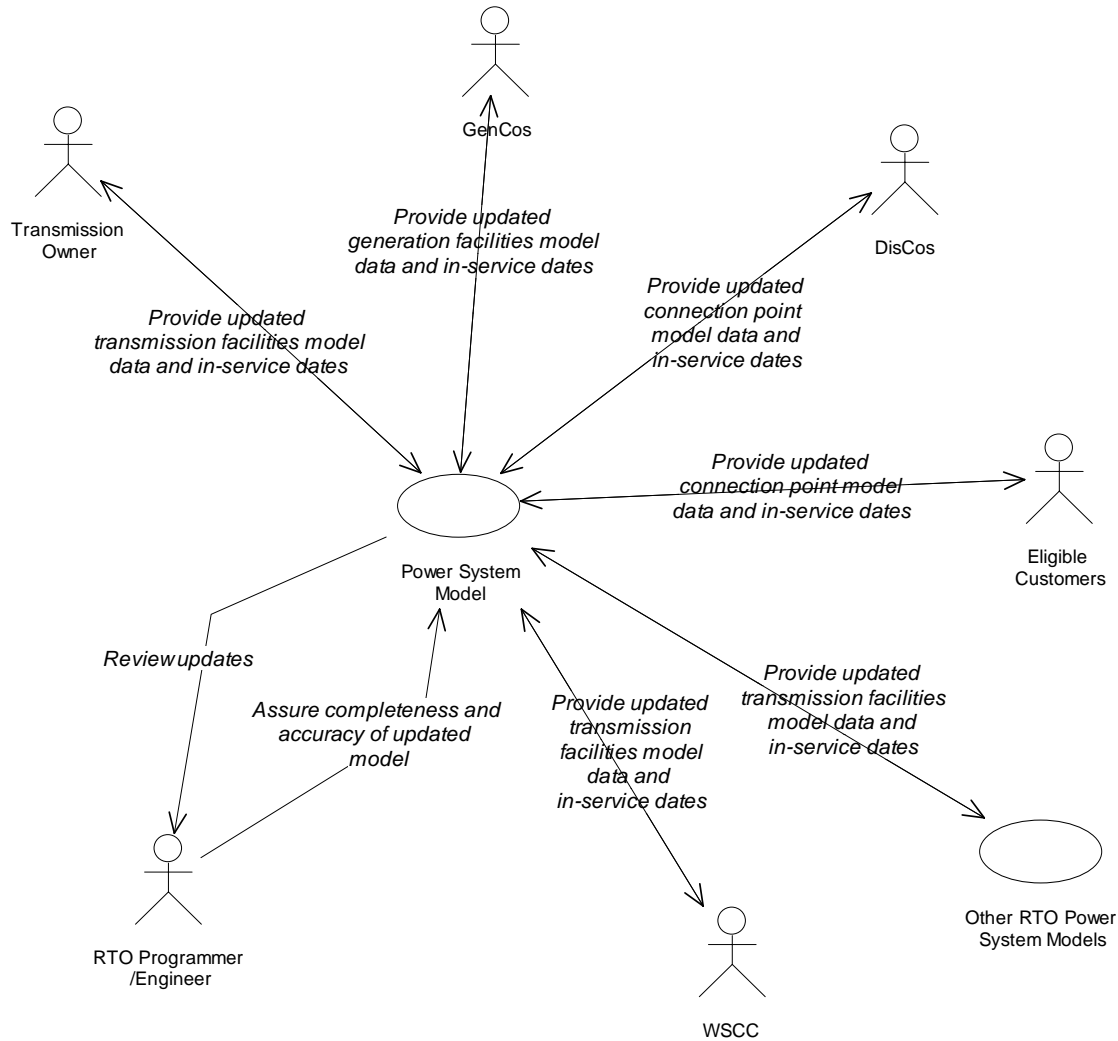

2.2 Maintenance Coordination Function (MC)

2.2.1 MC – Preconditions and Assumptions

Describe conditions that must exist prior to the initiation of the Function, such as prior state of the actors and activities

Identify any assumptions, such as what systems already exist, what contractual relations exist, and what configurations of systems are probably in place

Identify any initial states of information exchanged in the steps in the next section. For example, if a purchase order is exchanged in an activity, its precondition to the activity might be ‘filled in but unapproved’.

<i>Actor/System/Information/Contract</i>	<i>Preconditions or Assumptions</i>

2.2.2 MC – Steps – Normal Sequence

#	Event	Primary Actor	Name of Process/Activity	Description of Process/Activity	Information Producer	Information Receiver	Name of Info Exchanged	Additional Notes	IECSA Environments
									<i>Reference the applicable IECSA Environment containing this data exchange. Only one environment per step.</i>
2.1a	Periodically or upon event	Other 2 RTOs	Submit outage schedules	(1a) Submit relevant proposed transmission outage schedules	Other 2 RTOs	TransmissionOutageSchedule	Transmission outage schedules		RTOs / Market Participants
2.1b	Periodically or upon event	TransmissionOwner	Submit outage schedules	(1b) Submit long term proposed transmission outage schedules	TransmissionOwner	TransmissionOutageSchedule	Transmission outage schedules		Inter-Control Center
2.1c	Periodically or upon event	GenCos	Submit outage schedules	(1c) Submit long term proposed Local Generation Resources (LGR) generation maintenance schedules	GenCos	LGRGenerationMaintenanceSchedule	Generation maintenance schedules		Inter-Control Center
2.2a	After previous step	TransmissionOutageSchedule	Analyze outage schedules	(2a) Provide proposed transmission outage schedules	TransmissionOutageSchedule	MaintenanceOutageFunction	Transmission outage schedules		Inter-Control Center
2.2b		LGRGenerationMaintenanceSchedule	Analyze maintenance schedules	(2b) Provide proposed generation maintenance schedules	LGRGenerationMaintenanceSchedule	MaintenanceOutageFunction	Generation maintenance schedules		Inter-Control Center

#	Event	Primary Actor	Name of Process/Activity	Description of Process/Activity	Information Producer	Information Receiver	Name of Info Exchanged	Additional Notes	IECSA Environments
2.2c		PowerSystem Model	Provide power system model	(2c) Provide Base Case model	PowerSystem Model	Maintenance Outage Function	Power system model		Intra-Control Center
2.2d		Long Term Load Forecast	Provide load forecast	(2d) Provide LT Load Forecast	Long Term Load Forecast	Maintenance Outage Function	Load forecast		Intra-Control Center
2.2e		EnergyScheduleDatabase	Provide energy schedules	(2e) Provide all schedules already submitted by SchedulingCoordinator and all existing contracts	EnergyScheduleDatabase	Maintenance Outage Function	Energy schedules		Intra-Control Center
2.3	At specific time and date	Maintenance Outage Function	Determine acceptable schedules	(3) Once a month on a specific day, work with maintenance outage requests to determine acceptable outage schedules	Maintenance Outage Function	RTOScheduler	Outage schedules		User Interface
2.4a	After previous step	RTOScheduler	Accept transmission outage schedule	(4a) Accept transmission outage schedule	RTOScheduler	TransmissionOutageSchedule	Accepted transmission outage schedules		User Interface
2.4b		RTOScheduler	Reject transmission outage schedule	(4b) Reject transmission outage schedule	RTOScheduler	TransmissionOutageSchedule	Rejected transmission outage schedules		User Interface
2.4c		RTOScheduler	Accept generation maintenance schedule	(4c) Accept generation maintenance schedule	RTOScheduler	LGRGenerationMaintenanceSchedule	Accepted generation maintenance schedules		User Interface

#	Event	Primary Actor	Name of Process/Activity	Description of Process/Activity	Information Producer	Information Receiver	Name of Info Exchanged	Additional Notes	IECSA Environments
2.4d		RTOScheduler	Reject generation maintenance schedule	(4d) Reject generation maintenance schedule	RTOScheduler	LGRGenerationMaintenanceSchedule	Rejected generation maintenance schedules		User Interface
2.5a	After previous step		Transmission outage scheduling results	(5a) Receive acceptance or warning on transmission outage schedule	TransmissionOutageSchedule	Other 2 RTOs	Outage scheduling results		RTOs / Market Participants
2.5b			Transmission outage scheduling results	(5b) Receive acceptance or rejection of transmission outage schedules	TransmissionOutageSchedule	TransmissionOwner	Outage scheduling results		Intra-Control Center
2.5c			Generation maintenance results	(5c) Receive acceptance or rejection of LGR generation maintenance schedules	LGRGenerationMaintenanceSchedule	GenCos	Generation maintenance schedule results		Inter-Control Center

2.2.3 MC – Steps – Alternative / Exception Sequences

Describe any alternative or exception sequences that may be required that deviate from the normal course of activities. Note instructions are found in previous table.

#	Event	Primary Actor	Name of Process/Activity	Description of Process/Activity	Information Producer	Information Receiver	Name of Info Exchanged	Additional Notes	IECSA Environments

#	Event	Primary Actor	Name of Process/Activity	Description of Process/Activity	Information Producer	Information Receiver	Name of Info Exchanged	Additional Notes	IECSA Environments

2.2.4 MC – Post-conditions and Significant Results

Describe conditions that must exist at the conclusion of the Function. Identify significant items similar to that in the preconditions section.

Describe any significant results from the Function

<i>Actor/Activity</i>	<i>Post-conditions Description and Results</i>

2.2.5 MC – Architectural Issues in Interactions

Elaborate on all architectural issues in each of the steps outlined in each of the sequences above.

Reference the Step by number. Double click on the embedded excel file – record the changes and save the excel file (this updates the embedded attachment).



2.2.6 MC – Current Implementation Status

*Describe briefly the current implementation status of the function and/or parts of it, referring to Steps above
Identify the key existing products, standards and technologies*

<i>Product/Standard/Technology</i> Eg. DNP 3	<i>Ref - Usage</i> 2.1.2.1[1] - Exchange of SCADA information

Current Implementations:

<i>Relative maturity of function across industry:</i>	<i>Ref - Status Discussion</i>
Very mature and widely implemented	
Moderately mature	
Fairly new	Fairly new
Future, no systems, no interactions	

<i>Existence of legacy systems involved in function:</i>	<i>Ref - Status Discussion</i>
Many legacy systems	
Some legacy systems	

Few legacy systems	Few legacy systems
No legacy systems	
Extensive changes will be needed for full functionality	
Moderate changes will be needed	
Few changes will be needed	
No changes will be needed	

<i>Implementation Concerns</i>	<i>Ref - Status Discussion</i>
Data availability and accuracy	
Known and unknown market pressures	
Known and unknown technology opportunities	
Validation of capabilities of function	
Cost vs. benefit	

2.2.7 MC – Diagram

For clarification, draw (by hand, by Power Point, by UML diagram) the interactions, identifying the Steps where possible.

Long Term Transmission Outage and LGR Generation Maintenance Coordination Processes

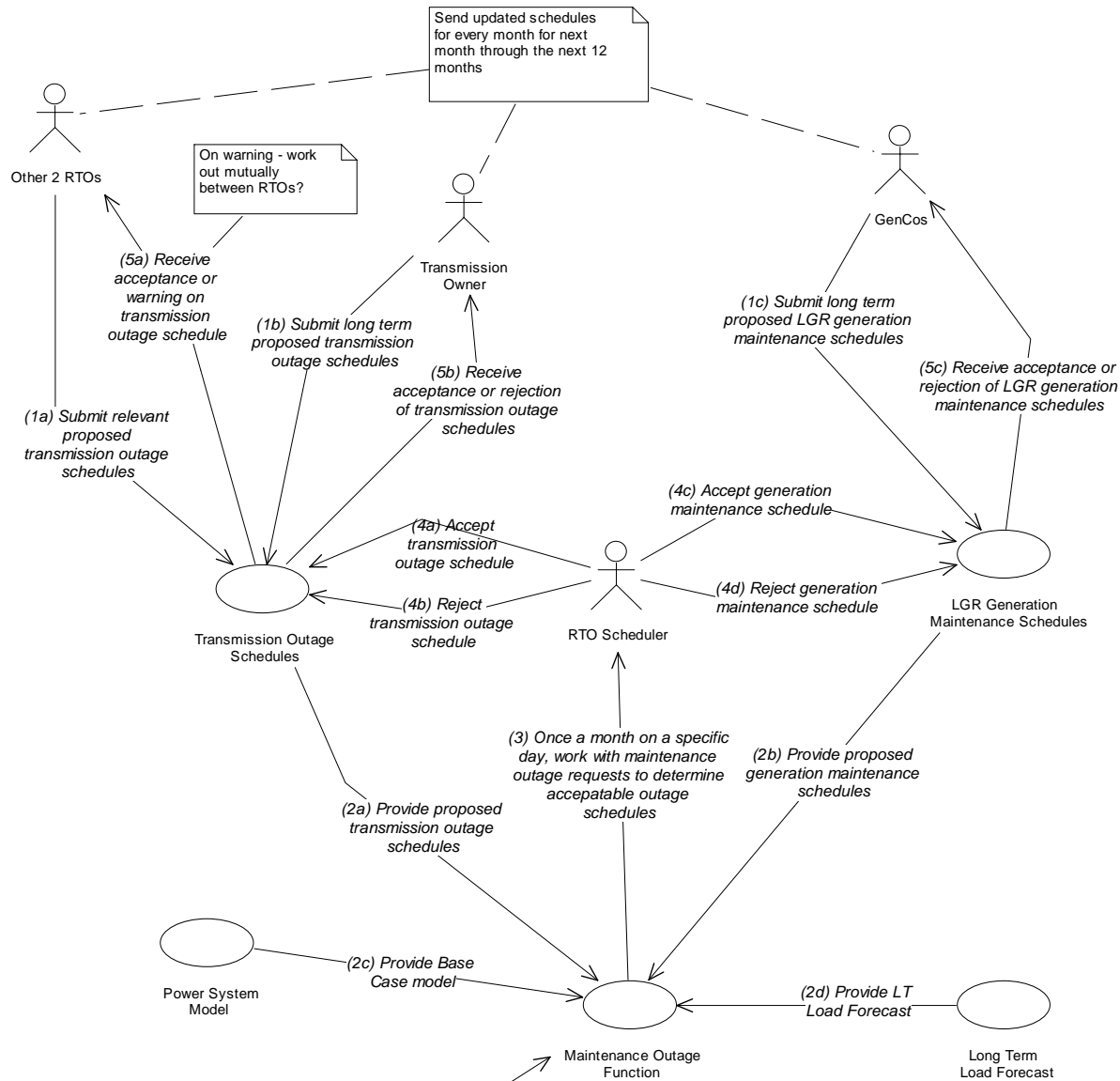

3 Auxiliary Issues

3.1 References and contacts

Documents and individuals or organizations used as background to the function described; other functions referenced by this function, or acting as “sub” functions; or other documentation that clarifies the requirements or activities described. All prior work (intellectual property of the company or individual) or proprietary (non-publicly available) work must be so noted.

ID	Title or contact	Reference or contact information
[1]		
[2]		

3.2 Action Item List

As the function is developed, identify issues that still need clarification, resolution, or other notice taken of them. This can act as an Action Item list.

ID	Description	Status
[1]		
[2]		

3.3 Revision History

For reference and tracking purposes, indicate who worked on describing this function, and what aspect they undertook.

No	Date	Author	Description
0.	February 27, 2004	Frances Cleveland	

No	Date	Author	Description

This page intentionally left blank.

Market Operations – Medium and Short Term Planning

1 Descriptions of Functions – Medium and Short Term Planning for Market Operations

All prior work (intellectual property of the company or individual) or proprietary (non-publicly available) work should be so noted.

1.1 Function Name

Name of Function

Market Operations – Medium and Short Term Planning for 3 Western Regional Transmission Organizations (RTOs)

1.2 Function ID

IECSA identification number of the function

M-2, M-3

1.3 Brief Description

Describe briefly the scope, objectives, and rationale of the Function.

As the electricity industry is deregulated, and as FERC defines more clearly what the market operation tariffs will encompass, three possible Regional Transmission Organizations (RTOs) in the Western Interconnection are developing seamless interfaces for Market Participants to submit energy schedules and ancillary service bids across these 3 RTOs. The 3 RTOs are California ISO (existing ISO handling the electricity market in California), RTO West (potential RTO of many northwestern utilities), and WestConnect (potential RTO of many southwestern utilities). These 3 RTOs are developing the requirements for the Western RTO functions.

1.4 Narrative

The following is a list of Western RTO functions related to medium and short term planning for market operations. The four functions with asterisks are described in this document.

1. Medium/Short Term Planning
 - a. Load Forecast *
 - b. Outage Scheduling *
 - c. Congestion Management *
 - d. Long term Auction/sale of CRRs *
 - e. Bilateral Energy Market

1.5 Actor (Stakeholder) Roles

Describe all the people (their job), systems, databases, organizations, and devices involved in or affected by the Function (e.g. operators, system administrators, technicians, end users, service personnel, executives, SCADA system, real-time database, RTO, RTU, IED, power system). Typically, these actors are logically grouped by organization or functional boundaries or just for collaboration purpose of this use case. We need to identify these groupings and their relevant roles and understand the constituency. The same actor could play different roles in different Functions, but only one role in one Function. If the same actor (e.g. the same person) does play multiple roles in one Function, list these different actor-roles as separate rows.

<i>Grouping (Community)'</i>		<i>Group Description</i>
<i>Market Operations</i>		
<i>Actor Name</i>	<i>Actor Type (person, device, system etc.)</i>	<i>Actor Description</i>
Area & Resource Operation Centers	Corporation	
AuditingPersonnel	Person	
DatabaseAdministrator	Person	
DisCos	Corporation	
DistributionSystem	System	

<i>Grouping (Community)'</i>		<i>Group Description</i>
<i>Market Operations</i>		
<i>Actor Name</i>	<i>Actor Type (person, device, system etc.)</i>	<i>Actor Description</i>
Eligible Customer Metered Entity	Person	
Eligible Customers	Person	
GenCos	Corporation	
IntervalMeterDevice	Device	
LGROwner	Person	
LoadProfile	Database	
MarketParticipant	Person	
Metered Entities	Corporation	
WeatherService	Corporation	
NERC	Corporation	
Other 2 RTOs	Corporation	
RetailCos	Corporation	
RTOOperator	Person	
RTOProgrammerEngineerPersonnel	Person	
RTOScheduler	Person	

<i>Grouping (Community)'</i>		<i>Group Description</i>
<i>Market Operations</i>		
<i>Actor Name</i>	<i>Actor Type (person, device, system etc.)</i>	<i>Actor Description</i>
SC-FTROwner	Person	
SchedulingCoordinator	Person	
SettlementAdministrator	Person	
SettlementDataMgmtAgent	Corporation	
CustomerMeterDevice	Device	
Tag Authority	Corporation	
TimeLineManager	Timer	
TransmissionOwner	Person	
TransmissionSystem	Power System	
WSCC	Corporation	
PowerSystemModel	Database	
RTOPowerSystemModelPowerSystemModel	Database	
TransmissionOutageSchedule	Database	
LGRGenerationMaintenanceSchedule	Database	
EnergyScheduleDatabase	Database	

<i>Grouping (Community)'</i>		<i>Group Description</i>
<i>Market Operations</i>		
<i>Actor Name</i>	<i>Actor Type (person, device, system etc.)</i>	<i>Actor Description</i>
AncillaryServiceSchedule	Database	
TransmissionRightOwnershipDatabase	Database	
FTR Requirements Matrix	Database	
TransmissionSystemCharacteristicsDatabase	Database	
Existing Transmission Contracts	Database	
OperatingPlan	Database	
Balancing Energy Stack	Database	
Available FTR		
CongestionManagementSystem		
Control (DAC) Subsystem		
Data Acquisition		
day Load Forecast		
FTR Market Clearing Price Auction Function		
HistoricLoadDatabase		

<i>Grouping (Community)'</i>		<i>Group Description</i>
<i>Market Operations</i>		
<i>Actor Name</i>	<i>Actor Type (person, device, system etc.)</i>	<i>Actor Description</i>
Maintenance Outage Function		
OperationalTransmissionCapacity		
WMI Web Server		

Replicate this table for each logic group.

1.6 Information Exchanged

Describe any information exchanged in this template.

<i>Information Object Name</i>	<i>Information Object Description</i>

1.7 Activities/Services

Describe or list the activities and services involved in this Function (in the context of this Function). An activity or service can be provided by a computer system, a set of applications, or manual procedures. These activities/services should be described at an appropriate level, with the understanding that sub-activities and services should be described if they are important for operational issues, automation needs, and implementation reasons. Other sub-activities/services could be left for later analysis.

<i>Activity/Service Name</i>	<i>Activities/Services Provided</i>
Maintenance Outage Function	Analyzes maintenance outages

<i>Activity/Service Name</i>	<i>Activities/Services Provided</i>
7-Day Load Forecast Function	Determines the long term load forecast
CongestionManagementSystem	Determines if congestion could occur
Operations Transmission Capacity	Determines the Operations Transmission Capacity, based on energy schedules
Western Market Interface Web Server	Manages the interface between the RTOs and the MarketParticipants
Data Acquisition and Control Subsystem	Monitors and controls field devices
Available FTR	Manages FTRs
FTR Market Clearing Price Auction Function	Determines market clearing price of FTRs based on energy schedules
EnergyScheduleDatabase Analysis Function	Analyzes the energy schedules
Ancillary Services Procurement Analysis	Analyzes the needs for ancillary services
Tag Approval Service	Approves electronic tags

1.8 Contracts/Regulations

Identify any overall (human-initiated) contracts, regulations, policies, financial considerations, engineering constraints, pollution constraints, and other environmental quality issues that affect the design and requirements of the Function.

<i>Contract/Regulation</i>	<i>Impact of Contract/Regulation on Function</i>
Market Tariff	
Agreements between RTOs	

<i>Policy</i>	<i>From Actor</i>	<i>May</i>	<i>Shall Not</i>	<i>Shall</i>	<i>Description (verb)</i>	<i>To Actor</i>

<i>Constraint</i>	<i>Type</i>	<i>Description</i>	<i>Applies to</i>

2 Step by Step Analysis of Function

Describe steps that implement the function. If there is more than one set of steps that are relevant, make a copy of the following section grouping (Preconditions and Assumptions, Steps normal sequence, and Steps alternate or exceptional sequence, Post conditions)

2.1 Load Forecasts (LF)

2.1.1 LF – Preconditions and Assumptions

Describe conditions that must exist prior to the initiation of the Function, such as prior state of the actors and activities

Identify any assumptions, such as what systems already exist, what contractual relations exist, and what configurations of systems are probably in place

Identify any initial states of information exchanged in the steps in the next section. For example, if a purchase order is exchanged in an activity, its precondition to the activity might be 'filled in but unapproved'.

<i>Actor/System/Information/Contract</i>	<i>Preconditions or Assumptions</i>

2.1.2 LF – Steps – Normal Sequence

#	Event	Primary Actor	Name of Process/Activity	Description of Process/Activity	Information Producer	Information Receiver	Name of Info Exchanged	Additional Notes	IECSA Environments
									<i>Reference the applicable IECSA Environment containing this data exchange. Only one environment per step.</i>
1.1a	Periodic or event driven	SchedulingCoordinator	Load estimates	Provides load MW estimates from Day Ahead schedules as an auxiliary source of LF data	SchedulingCoordinator	7-day Load Forecast	Load estimates		User Interface
1.1b	In parallel to step 1a	WeatherService	Forecast weather	Provides weather forecasts and updates for each region	WeatherService	7-day Load Forecast	Weather data		RTOs / Market Participants
1.1c	In parallel to step 1a	TransmissionOwner	Regional loads	Provides regional LF estimates as auxiliary source of LF data	TransmissionOwner	7-day Load Forecast	Load estimates		RTOs / Market Participants
1.1d	In parallel to step 1a	HistoricLoadDatabase	Historical forecasts	Provides historical input for forecast	HistoricLoadDatabase	7-day Load Forecast	Historical forecasts		RTOs / Market Participants
1.2	Upon completion of previous step	RTO Scheduler	Adjust forecasts	Adjusts load forecast	RTO Scheduler	7-day Load Forecast	Adjustments		User Interface
1.3	Upon completion of previous step	7-day Load Forecast	Issue load forecasts	Provides 7-day regional load forecasts	7-day Load Forecast	Market Participant	Load forecasts		RTOs / Market Participants

2.1.3 LF – Steps – Alternative / Exception Sequences

Describe any alternative or exception sequences that may be required that deviate from the normal course of activities. Note instructions are found in previous table.

#	Event	Primary Actor	Name of Process/Activity	Description of Process/Activity	Information Producer	Information Receiver	Name of Info Exchanged	Additional Notes	IECSA Environments

2.1.4 LF – Post-conditions and Significant Results

Describe conditions that must exist at the conclusion of the Function. Identify significant items similar to that in the preconditions section.

Describe any significant results from the Function

<i>Actor/Activity</i>	<i>Post-conditions Description and Results</i>

2.1.5 LF – Architectural Issues in Interactions

Elaborate on all architectural issues in each of the steps outlined in each of the sequences above. Reference the Step by number.

2.1.6 LF – Current Implementation Status

*Describe briefly the current implementation status of the function and/or parts of it, referring to Steps above
Identify the key existing products, standards and technologies*

<i>Product/Standard/Technology</i> Eg. DNP 3	<i>Ref - Usage</i> 2.1.2.1[1] - Exchange of SCADA information

Current Implementations:

<i>Relative maturity of function across industry:</i>	<i>Ref - Status Discussion</i>
Very mature and widely implemented	Load forecast is very mature application
Moderately mature	
Fairly new	
Future, no systems, no interactions	

<i>Existence of legacy systems involved in function:</i>	<i>Ref - Status Discussion</i>
Many legacy systems	
Some legacy systems	
Few legacy systems	
No legacy systems	
Extensive changes will be needed for full functionality	
Moderate changes will be needed	
Few changes will be needed	
No changes will be needed	

<i>Implementation Concerns</i>	<i>Ref - Status Discussion</i>
Data availability and accuracy	
Known and unknown market pressures	
Known and unknown technology opportunities	
Validation of capabilities of function	
Cost vs. benefit	

2.1.7 LF – Diagram

For clarification, draw (by hand, by Power Point, by UML diagram) the interactions, identifying the Steps where possible.

Mid Term and Short Term Load Forecast Process

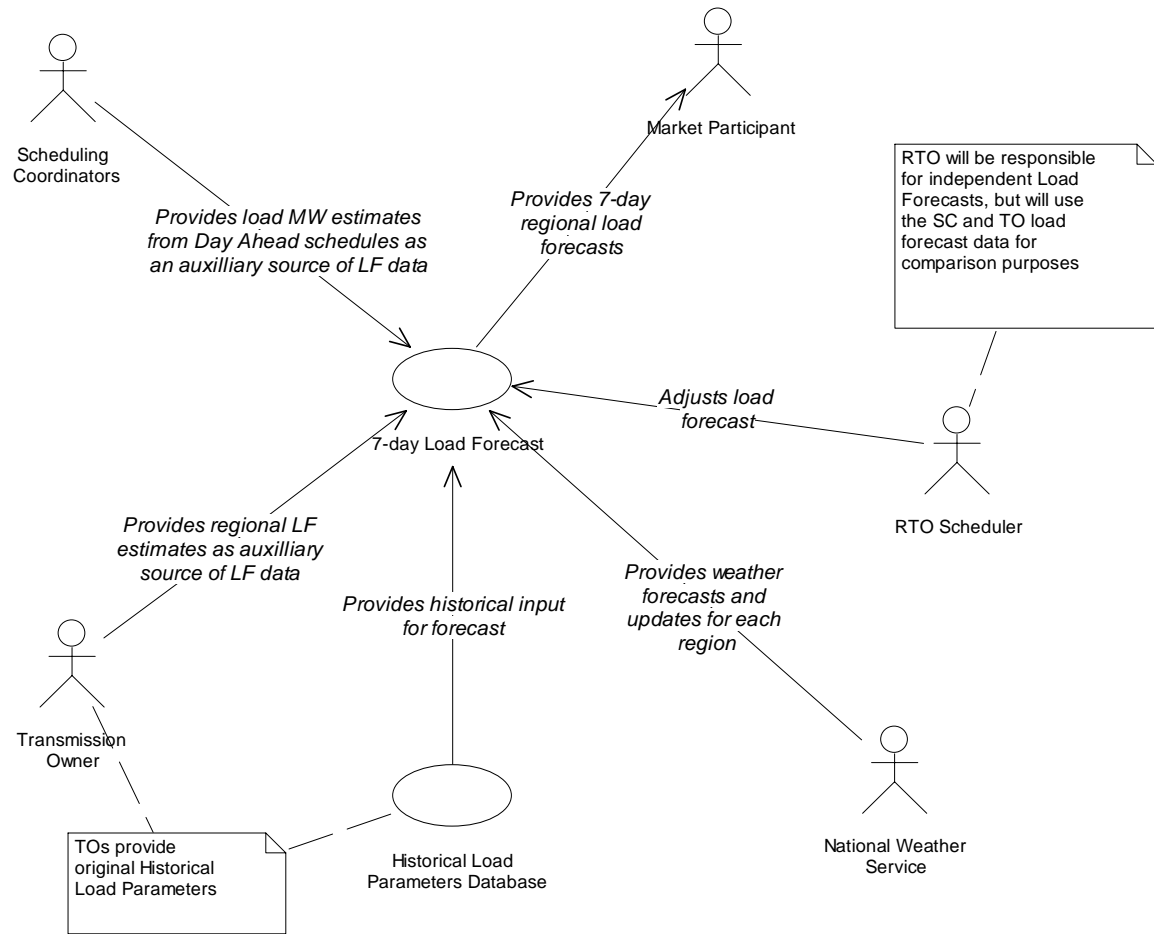

2.2 Outage Scheduling (OS)

2.2.1 OS – Preconditions and Assumptions

Describe conditions that must exist prior to the initiation of the Function, such as prior state of the actors and activities

Identify any assumptions, such as what systems already exist, what contractual relations exist, and what configurations of systems are probably in place

Identify any initial states of information exchanged in the steps in the next section. For example, if a purchase order is exchanged in an activity, its precondition to the activity might be 'filled in but unapproved'.

<i>Actor/System/Information/Contract</i>	<i>Preconditions or Assumptions</i>

2.2.2 Outage Scheduling (OS) – Steps – Normal Sequence

#	Event	Primary Actor	Name of Process/Activity	Description of Process/Activity	Information Producer	Information Receiver	Name of Info Exchanged	Additional Notes	IECSA Environments
									<i>Reference the applicable IECSA Environment containing this data exchange. Only one environment per step.</i>
2.1a	As needed before a specific day and time when maintenance coordination is to be performed	Scheduling Coordinator	Send generation outages	(1a) Send Day Ahead Local Generation Resources (LGR) outages, limit and ramp rate changes, and notification of non-LGR units	Scheduling Coordinator	LGR Generation Maintenance Schedule	Generation outages		User Interface
2.1b	In parallel to step 1a	Transmission Owner	Send transmission outages	(1b) Request Day Ahead transmission maintenance outages	Transmission Owner	Transmission Outage Schedule	Transmission outages		RTOs / Market Participants
2.1c	In parallel to step 1a	Other 2 RTOs	Send other RTO transmission outages	(1c) Notify of relevant transmission outages	Other 2 RTOs	Transmission Outage Schedule	Transmission outages		RTOs / Market Participants
2.2a	On the specific day and time	LGR Generation Maintenance Schedule	Provide outage schedules	(2a) Provide proposed outage schedules	LGR Generation Maintenance Schedule	Maintenance Outage Function	Generation outages		HV Generation Plant
2.2b	In parallel to step 2a	Transmission Outage Schedule	Provide outage schedules	(2b) Provide proposed outage schedules	Transmission Outage Schedule	Maintenance Outage Function	Transmission outages		User Interface

#	Event	Primary Actor	Name of Process/Activity	Description of Process/Activity	Information Producer	Information Receiver	Name of Info Exchanged	Additional Notes	IECSA Environments
2.3a	On the specific day and time	EnergyScheduleDatabase	Provide energy schedules	(3a) Provide proposed energy schedules	EnergyScheduleDatabase	Maintenance Outage Function	Energy schedules		RTOs / Market Participants
2.3b	In parallel to step 3a	7-day Load Forecast	Provide load forecast	(3b) Provide 7-day load forecasts for each region	7-day Load Forecast	Maintenance Outage Function	Load forecasts		RTOs / Market Participants
2.4	After previous step	Maintenance Outage Function	Review outages	(4) Reviews result of Maintenance Outages	Maintenance Outage Function	RTOScheduler	Generation outages Transmission outages		User Interface
2.5a	When RTOScheduler analyzes the impact of outages	RTOScheduler	Analysis of LGR outages	(5a) Approves or rejects LGR outage	RTOScheduler	LGRGenerationMaintenanceSchedule	Indication of approval and rejection of LGR maintenance schedules		User Interface
2.5b	In parallel to step 5a	RTOScheduler	Analysis of transmission outages	(5b) Approves or rejects transmission outage schedules	RTOScheduler	TransmissionOutageSchedule	Indication of approval and rejection of transmission outage schedules		User Interface
2.6a	After previous step	LGRGenerationMaintenanceSchedule	Notify LGR owners	(6a) Notify LGR Owner of approvals and rejections	LGRGenerationMaintenanceSchedule	SchedulingCoordinator	Indication of approval and rejection of LGR maintenance schedules		User Interface
2.6b	In parallel to step 6a	TransmissionOutageSchedule	Notify transmission owners	(6b) Notify TO of approvals and rejections	TransmissionOutageSchedule	TransmissionOwner	Indication of approval and rejection of transmission outage schedules		RTOs / Market Participants

#	Event	Primary Actor	Name of Process/Activity	Description of Process/Activity	Information Producer	Information Receiver	Name of Info Exchanged	Additional Notes	IECSA Environments
2.6c	In parallel to step 6a	Transmission OutageSchedule	Warnings on contingencies	(6c) Warn of potential contingencies	TransmissionOutageSchedule	Other 2 RTOs	Contingency warnings		RTOs / Market Participants

2.2.3 OS – Steps – Alternative / Exception Sequences

Describe any alternative or exception sequences that may be required that deviate from the normal course of activities. Note instructions are found in previous table.

#	Event	Primary Actor	Name of Process/Activity	Description of Process/Activity	Information Producer	Information Receiver	Name of Info Exchanged	Additional Notes	IECSA Environments

2.2.4 OS – Post-conditions and Significant Results

Describe conditions that must exist at the conclusion of the Function. Identify significant items similar to that in the preconditions section.

Describe any significant results from the Function

<i>Actor/Activity</i>	<i>Post-conditions Description and Results</i>

<i>Actor/Activity</i>	<i>Post-conditions Description and Results</i>

2.2.5 OS – Architectural Issues in Interactions

Elaborate on all architectural issues in each of the steps outlined in each of the sequences above. Reference the Step by number. Double click on the embedded excel file – record the changes and save the excel file (this updates the embedded attachment).

2.2.6 OS – Current Implementation Status

Describe briefly the current implementation status of the function and/or parts of it, referring to Steps above. Identify the key existing products, standards and technologies

<i>Product/Standard/Technology</i> Eg. DNP 3	<i>Ref - Usage</i> 2.1.2.1[1] - Exchange of SCADA information

Current Implementations:

<i>Relative maturity of function across industry:</i>	<i>Ref - Status Discussion</i>
Very mature and widely implemented	
Moderately mature	

<i>Relative maturity of function across industry:</i>	<i>Ref - Status Discussion</i>
Fairly new	Fairly new
Future, no systems, no interactions	

<i>Existence of legacy systems involved in function:</i>	<i>Ref - Status Discussion</i>
Many legacy systems	
Some legacy systems	
Few legacy systems	Very few legacy systems
No legacy systems	
Extensive changes will be needed for full functionality	
Moderate changes will be needed	
Few changes will be needed	
No changes will be needed	

<i>Implementation Concerns</i>	<i>Ref - Status Discussion</i>
Data availability and accuracy	
Known and unknown market pressures	Could have market pressures changing functionality
Known and unknown technology opportunities	
Validation of capabilities of function	
Cost vs. benefit	

2.2.7 OS – Diagram

For clarification, draw (by hand, by Power Point, by UML diagram) the interactions, identifying the Steps where possible.

Day Ahead Transmission Outage and LGR Outage Scheduling

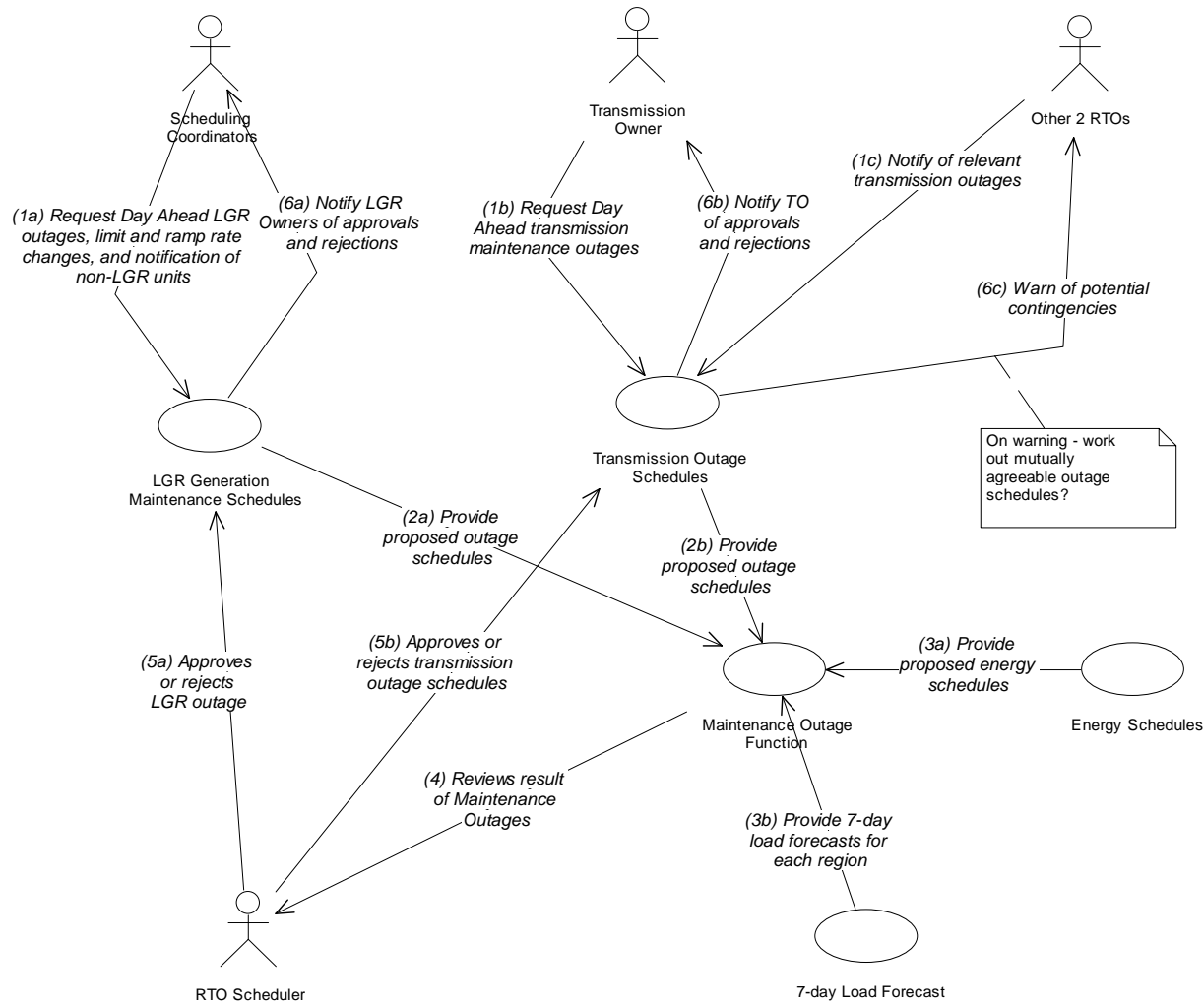

2.3 Congestion Management (CM)

2.3.1 CM – Preconditions and Assumptions

Describe conditions that must exist prior to the initiation of the Function, such as prior state of the actors and activities

Identify any assumptions, such as what systems already exist, what contractual relations exist, and what configurations of systems are probably in place

Identify any initial states of information exchanged in the steps in the next section. For example, if a purchase order is exchanged in an activity, its precondition to the activity might be ‘filled in but unapproved’.

<i>Actor/System/Information/Contract</i>	<i>Preconditions or Assumptions</i>

2.3.2 CM – Steps – Normal Sequence

#	Event	Primary Actor	Name of Process/Activity	Description of Process/Activity	Information Producer	Information Receiver	Name of Info Exchanged	Additional Notes	IECSA Environments
									<i>Reference the applicable IECSA Environment containing this data exchange. Only one environment per step.</i>
3.1a	Periodically and/or at specific times and dates	Transmission Owner	Update constraints	(1a) Update transmission path constraints for each future hour	TransmissionOwner	TransmissionSystemCharacteristicsDatabase	Future constraints		RTOs / Market Participants
3.1b	In parallel to step 1a	Data Acquisition and Control (DAC) Subsystem	Update constraints	(1b) Provide real-time data on transmission constraints and outages	Data Acquisition and Control (DAC) Subsystem	TransmissionSystemCharacteristicsDatabase	Real-time constraints		RTOs / Market Participants
3.1c	In parallel to step 1a	Other 2 RTOs	Update constraints	(1c) Update relevant transmission path constraints for each future hour	Other 2 RTOs	TransmissionSystemCharacteristicsDatabase	Future and real-time constraints		RTOs / Market Participants
3.2a	Periodically or upon request or upon event	Transmission RightOwnershipDatabase	Provide FTRs	(2a) Provide list of Firm Transmission Rights (FTR) Interfaces and Scheduling Points	TransmissionRightOwnershipDatabase	CongestionManagementSystem	FTRs		RTOs / Market Participants
3.2b	In parallel to step 2a	Transmission OutageSchedule	Provide transmission outages	(2b) Provide approved transmission outage schedules for the appropriate timeframes	TransmissionOutageSchedule	CongestionManagementSystem	Transmission outage schedules		User Interface

#	Event	Primary Actor	Name of Process/Activity	Description of Process/Activity	Information Producer	Information Receiver	Name of Info Exchanged	Additional Notes	IECSA Environments
3.2c	In parallel to step 2a	LGR Generation Maintenance Schedule	Provide LGR outage schedules	(2c) Provide approved LGR outage schedules for the appropriate timeframes	LGR Generation Maintenance Schedule	Congestion Management System	LGR outage schedules		RTOs / Market Participants
3.2d	In parallel to step 2a	Transmission System Characteristics Database	Provide transmission conditions	(2d) Provide update of transmission conditions for the appropriate timeframes	Transmission System Characteristics Database	Congestion Management System	Transmission conditions		RTOs / Market Participants
3.3	Periodically	Congestion Management System	Calculate TTC, ATC, and OTC	(3) Calculate TTC, ATC, and OTC for each FTR Interface and Scheduling Point	Congestion Management System	Operational Transmission Capacity	TTC, ATC, & OTC		RTOs / Market Participants
3.4	Upon request	Operational Transmission Capacity	Review OTC	(4) Review OTC data	Operational Transmission Capacity	RTOS Scheduler	OTC		User Interface
3.5	By specific date and time	RTOS Scheduler	Approve OTC	(5) Approve OTC data	RTOS Scheduler	Operational Transmission Capacity	OTC approvals		User Interface
3.6a	By specific data and time	Operational Transmission Capacity	Updated OTC	(6a) Provide updated TTC, ATC, and OTC data	Operational Transmission Capacity	WMI Web Server	TTC, ATC, & OTC		RTOs / Market Participants
3.6b	In parallel to step 6a	FTR Requirements Matrix	Calculate FDF	(6b) Provide updated Flow Distribution Factors (FDF)	FTR Requirements Matrix	WMI Web Server	FDF		RTOs / Market Participants
3.6c	In parallel to step 6a	Operational Transmission Capacity	Updated OTC	(6c) Provide updated TTC, ATC, and OTC data	Operational Transmission Capacity	Other 2 RTOs	TTC, ATC, & OTC		RTOs / Market Participants

#	Event	Primary Actor	Name of Process/Activity	Description of Process/Activity	Information Producer	Information Receiver	Name of Info Exchanged	Additional Notes	IECSA Environments
3.7	At specific date and time	WMI Web Server	Provide TTC, ATC, and OTC	(7) Provide TTC, ATC, OTC, and FDF data to MarketParticipants	WMI Web Server	MarketParticipant	TTC, ATC, & OTC		RTOs / Market Participants

2.3.3 CM – Steps – Alternative / Exception Sequences

Describe any alternative or exception sequences that may be required that deviate from the normal course of activities. Note instructions are found in previous table.

#	Event	Primary Actor	Name of Process/Activity	Description of Process/Activity	Information Producer	Information Receiver	Name of Info Exchanged	Additional Notes	IECSA Environments

2.3.4 CM – Post-conditions and Significant Results

Describe conditions that must exist at the conclusion of the Function. Identify significant items similar to that in the preconditions section.

Describe any significant results from the Function

<i>Actor/Activity</i>	<i>Post-conditions Description and Results</i>

2.3.5 CM – Architectural Issues in Interactions

Elaborate on all architectural issues in each of the steps outlined in each of the sequences above. Reference the Step by number. Double click on the embedded excel file – record the changes and save the excel file (this updates the embedded attachment).

2.3.6 CM – Current Implementation Status

Describe briefly the current implementation status of the function and/or parts of it, referring to Steps above

Identify the key existing products, standards and technologies

<i>Product/Standard/Technology</i>	<i>Ref - Usage</i>
Eg. DNP 3	2.1.2.1[1] - Exchange of SCADA information

Current Implementations:

<i>Relative maturity of function across industry:</i>	<i>Ref - Status Discussion</i>
Very mature and widely implemented	
Moderately mature	
Fairly new	Fairly new
Future, no systems, no interactions	

<i>Existence of legacy systems involved in function:</i>	<i>Ref - Status Discussion</i>
Many legacy systems	
Some legacy systems	
Few legacy systems	Very few legacy systems
No legacy systems	
Extensive changes will be needed for full functionality	
Moderate changes will be needed	
Few changes will be needed	
No changes will be needed	

<i>Implementation Concerns</i>	<i>Ref - Status Discussion</i>
Data availability and accuracy	
Known and unknown market pressures	Could have market pressures changing functionality
Known and unknown technology opportunities	
Validation of capabilities of function	
Cost vs. benefit	

2.3.7 CM – Diagram

For clarification, draw (by hand, by Power Point, by UML diagram) the interactions, identifying the Steps where possible.

Annual, Monthly, Daily, and Hourly Congestion Management Process to Determine TTC, ATC, and OTC

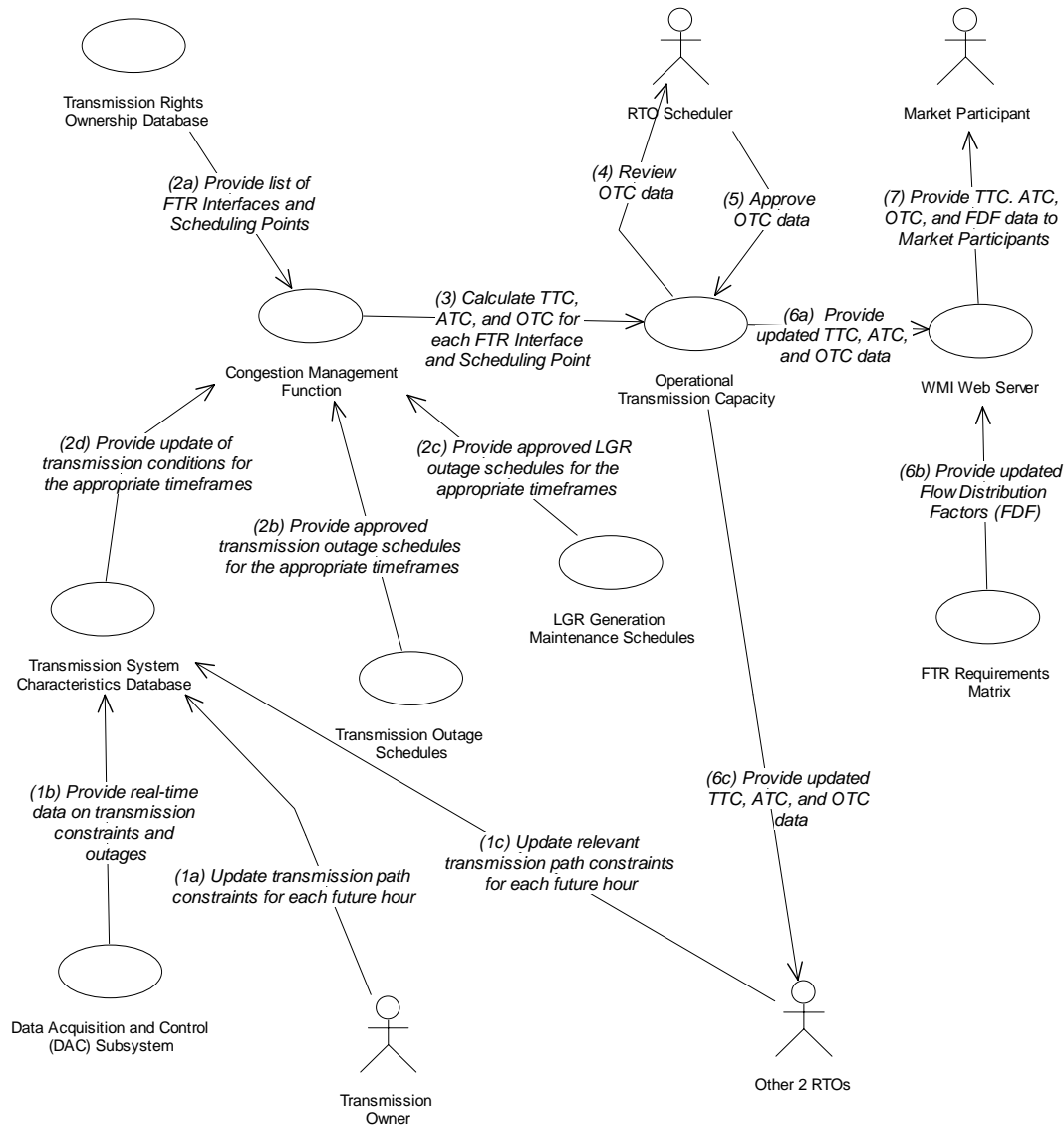

2.4 Long Term Auction of Transmission Rights (LTATR)

2.4.1 LTATR – Preconditions and Assumptions

Describe conditions that must exist prior to the initiation of the Function, such as prior state of the actors and activities

Identify any assumptions, such as what systems already exist, what contractual relations exist, and what configurations of systems are probably in place

Identify any initial states of information exchanged in the steps in the next section. For example, if a purchase order is exchanged in an activity, its precondition to the activity might be ‘filled in but unapproved’.

<i>Actor/System/Information/Contract</i>	<i>Preconditions or Assumptions</i>

2.4.2 LTATR – Steps – Normal Sequence

#	Event	Primary Actor	Name of Process/Activity	Description of Process/Activity	Information Producer	Information Receiver	Name of Info Exchanged	Additional Notes	IECSA Environments
									<i>Reference the applicable IECSA Environment containing this data exchange. Only one environment per step.</i>
4.0	As needed	RTOProgrammerEngineerPersonnel	Input schedules	(As needed) Input schedules for legal existing contractual agreements	RTOProgrammerEngineerPersonnel	Existing Transmission Contracts	Transmission contracts		RTOs / Market Participants
4.1	Periodically or at specific time and date	Existing Transmission Contracts	Provide OTC	(1) Provide capacity needed for existing contracts	Existing Transmission Contracts	OperationalTransmissionCapacity	Transmission contracts		RTOs / Market Participants
4.2	After previous step	OperationalTransmissionCapacity	Calculate FTR	(2) Calculate conservative FTR from OTC minus previously auctioned FTRs, minus existing contracts	OperationalTransmissionCapacity	Available FTR	OTC		RTOs / Market Participants
4.3	At specific time and date	TimeLineManager	Trigger posting of FTR	(3) Trigger posting of FTRs	TimeLineManager	Available FTR	Trigger		RTOs / Market Participants
4.4	At specific time and date	Available FTR	Post FTR	(4) Post available FTRs, transmission outage schedules, & generation maintenance schedules	Available FTR	WMI Web Server	FTR		RTOs / Market Participants
4.5a	On-going	SchedulingCoordinator	Enter bids	(5a) Enter bids for FTRs	SchedulingCoordinator	WMI Web Server	Bids for FTR		User Interface

#	Event	Primary Actor	Name of Process/Activity	Description of Process/Activity	Information Producer	Information Receiver	Name of Info Exchanged	Additional Notes	IECSA Environments
4.5b	In parallel to step 5a	Eligible Customers	Enter bids	(5b) Enter bids for FTRs	Eligible Customers	WMI Web Server	Bids for FTR		User Interface
4.6	Before auction time	WMI Web Server	Receive bids	(6) Receive FTR bids during auction	WMI Web Server	FTR Market Clearing Price Auction Function	Bids for FTR		RTOs / Market Participants
4.7	At auction time	TimeLineManager	Trigger auction	(7) Trigger auction function	TimeLineManager	FTR Market Clearing Price Auction Function	Trigger		RTOs / Market Participants
4.8a	After previous step	FTR Market Clearing Price Auction Function	Post FTR winners	(8a) Post winners of FTR auction after auction close	FTR Market Clearing Price Auction Function	WMI Web Server	FTR winners		RTOs / Market Participants
4.8b	In parallel to step 8a	FTR Market Clearing Price Auction Function	Store FTRs	(8b) Store ownership of FTRs	FTR Market Clearing Price Auction Function	TransmissionRightOwnership Database	FTR owners		RTOs / Market Participants
4.9a	After previous step	WMI Web Server	Notify winners	(9a) Notify winners (and losers) of FTR	WMI Web Server	SchedulingCoordinator	FTR winners		User Interface
4.9b	In parallel to step 9a	WMI Web Server	Notify winners	(9b) Notify winners (and losers) of FTR	WMI Web Server	Eligible Customers	FTR winners		User Interface
4.9c	In parallel to step 9a	WMI Web Server	Provide FTR information	(9c) Provide FTR information to RTOs	WMI Web Server	Other 2 RTOs	FTR winners		RTOs / Market Participants

2.4.3 LTATR – Steps – Alternative / Exception Sequences

Describe any alternative or exception sequences that may be required that deviate from the normal course of activities. Note instructions are found in previous table.

#	Event	Primary Actor	Name of Process/Activity	Description of Process/Activity	Information Producer	Information Receiver	Name of Info Exchanged	Additional Notes	IECSA Environments

2.4.4 LTATR – Post-conditions and Significant Results

Describe conditions that must exist at the conclusion of the Function. Identify significant items similar to that in the preconditions section.

Describe any significant results from the Function

<i>Actor/Activity</i>	<i>Post-conditions Description and Results</i>

2.4.5 LTATR – Architectural Issues in Interactions

Elaborate on all architectural issues in each of the steps outlined in each of the sequences above. Reference the Step by number. Double click on the embedded excel file – record the changes and save the excel file (this updates the embedded attachment).

2.4.6 LTATR – Current Implementation Status

Describe briefly the current implementation status of the function and/or parts of it, referring to Steps above

Identify the key existing products, standards and technologies

<i>Product/Standard/Technology</i> Eg. DNP 3	<i>Ref - Usage</i> 2.1.2.1[1] - Exchange of SCADA information

Current Implementations:

<i>Relative maturity of function across industry:</i>	<i>Ref - Status Discussion</i>
Very mature and widely implemented	
Moderately mature	
Fairly new	Fairly new
Future, no systems, no interactions	

<i>Existence of legacy systems involved in function:</i>	<i>Ref - Status Discussion</i>
Many legacy systems	
Some legacy systems	

Few legacy systems	Very few legacy systems
No legacy systems	
Extensive changes will be needed for full functionality	
Moderate changes will be needed	
Few changes will be needed	
No changes will be needed	

<i>Implementation Concerns</i>	<i>Ref - Status Discussion</i>
Data availability and accuracy	
Known and unknown market pressures	Could have market pressures changing functionality
Known and unknown technology opportunities	
Validation of capabilities of function	
Cost vs. benefit	

2.4.7 LTATR – Diagram

For clarification, draw (by hand, by Power Point, by UML diagram) the interactions, identifying the Steps where possible.

Annual, Monthly, and 2-day Ahead Auctioning of FTRs Processes

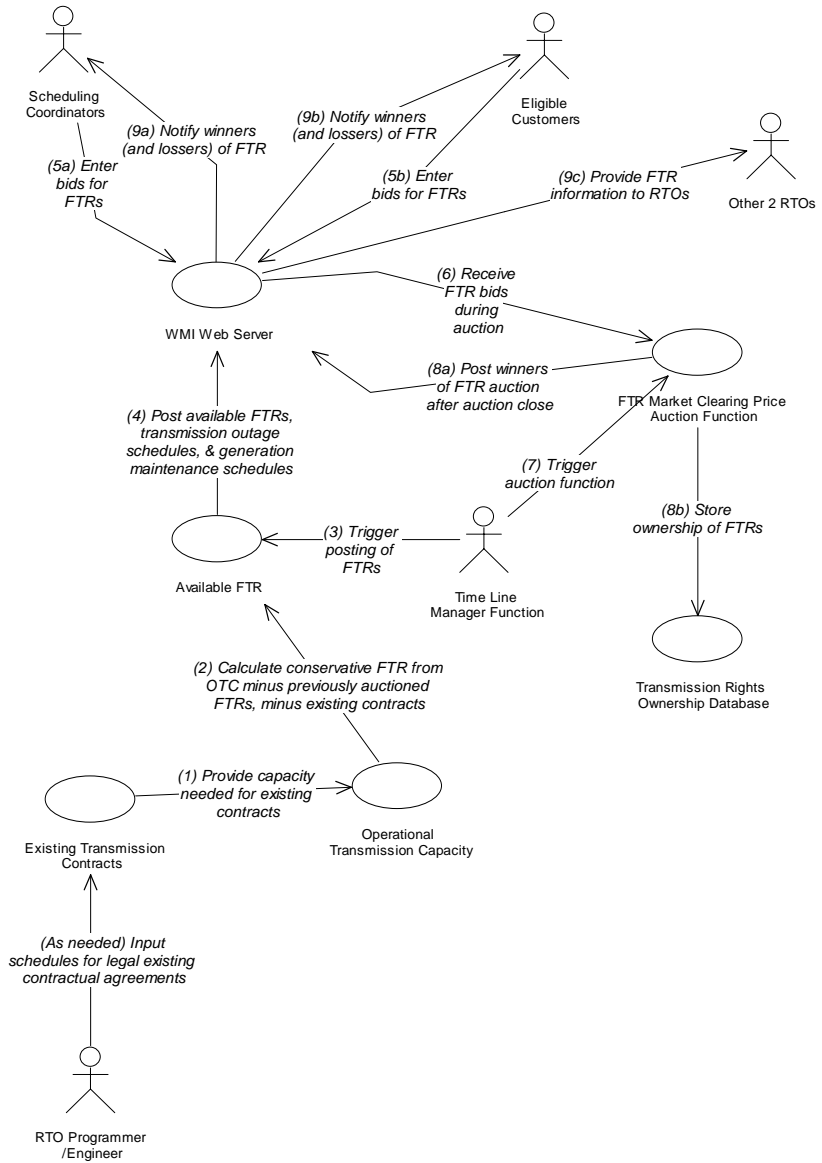

3 Auxiliary Issues

3.1 References and contacts

Documents and individuals or organizations used as background to the function described; other functions referenced by this function, or acting as “sub” functions; or other documentation that clarifies the requirements or activities described. All prior work (intellectual property of the company or individual) or proprietary (non-publicly available) work must be so noted.

ID	Title or contact	Reference or contact information
[1]		
[2]		

3.2 Action Item List

As the function is developed, identify issues that still need clarification, resolution, or other notice taken of them. This can act as an Action Item list.

ID	Description	Status
[1]		
[2]		

3.3 Revision History

For reference and tracking purposes, indicate who worked on describing this function, and what aspect they undertook.

No	Date	Author	Description
0.	February 27, 2004	Frances Cleveland	

Market Operations – Overview

1 Descriptions of Functions – Overview of Market Operations

All prior work (intellectual property of the company or individual) or proprietary (non-publicly available) work should be so noted.

1.1 Function Name

Name of Function

Market Operations across 3 Western Regional Transmission Organizations (RTOs)

1.2 Function ID

IECSA identification number of the function

M-1,M-2,M-3,M-4,M-5,M-6

1.3 Brief Description

Describe briefly the scope, objectives, and rationale of the Function.

As the electricity industry is deregulated, and as FERC defines more clearly what the market operation tariffs will encompass, three possible Regional Transmission Organizations (RTOs) in the Western Interconnection are developing seamless interfaces for Market Participants to submit energy schedules and ancillary service bids across these 3 RTOs. The 3 RTOs are California ISO (existing ISO handling the electricity market in California), RTO West (potential RTO of many northwestern utilities), and WestConnect (potential RTO of many southwestern utilities). These 3 RTOs are developing the requirements for the Western RTO functions.

The descriptions of the functions below may or may not represent the final market rules and market operations, because these have not been finalized yet.

1.4 Narrative

A complete narrative of the Function from a Domain Expert's point of view, describing what occurs when, why, how, and under what conditions. This will be a separate document, but will act as the basis for identifying the Steps in Section 2.

The following is a list of Western RTO functions related to market operations, organized for convenience by timeline. These functions have never been implemented as yet because the actual market rules have not been agreed upon and are waiting for some general FERC decisions and some FERC RTO-specific approvals. Nonetheless, the functions represent conceptually many of the key types of market operations that are need in any electricity market.

This document is an overview of the Western RTO functions and does not include any of the step by step details, which are provided in the detailed documents. Only the listed functions with asterisks are represented in the diagrams and/or step-by-step descriptions in those documents' section 2.

1. Long Term Planning
 - a. Registration of Market Participants
 - b. Capacity/Adequacy Market
 - c. Transmission and Generation Maintenance Coordination *
 - d. Updating the Power System Model *
 - e. Generation certification
2. Medium/Short Term Planning
 - a. Load Forecast *
 - b. Outage Scheduling *
 - c. Congestion Management *
 - d. Long term Auction/sale of FTRs *
 - e. Bilateral Energy Market
3. Day Ahead Market
 - a. Auction/sale of FTRs *
 - b. Day Ahead Submittal of Energy Schedules *
 - c. Day Ahead Submittal of Ancillary Service Bids *
 - d. Schedule Adjustment of Energy Schedules *
 - e. Schedule Adjustment of Ancillary Services *
 - f. NERC Tagging Management *

4. Real-Time
 - a. Operational calculations
 - b. Real-time Submittal of Schedules
 - c. Real-time Submittal of Ancillary Services
 - d. Normal Real-Time Dispatch Operations *
 - e. Normal Generation Control Operations *
 - f. Scheduling Coordinators Redispatch *
 - Redispatch
 - Notify Scheduling Coordinators of redispatch
 - g. Emergency Ancillary Services *
 - h. Real-Time Power System Historical Records *
5. Post-Dispatch
 - a. Metering Data Collection *
 - Register meters
 - Process meter revenue data
 - b. Transmission and Distribution Schedule Checkout *
 - c. Financial Settlements *
 - LMP Calculation
 - Losses calculation
 - Reconcile ISO market
 - Reconcile real-time market
 - Resolve disputes
 - d. Accounting and Billing *
 - Create budget and financial forecast
 - Manage accounts payable
 - Manage accounts receivable
 - Purchasing
 - e. Market Monitoring and Auditing *
 - Develop monitoring criteria
 - Perform market assessment
 - Investigate market abuse

Overview of Western RTOs Business Processes

Long Term Planning Processes

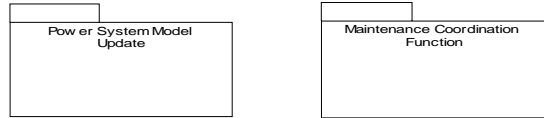

Medium and Short Term Planning Processes



Day Ahead through Schedule Adjustment Transmission Market Processes

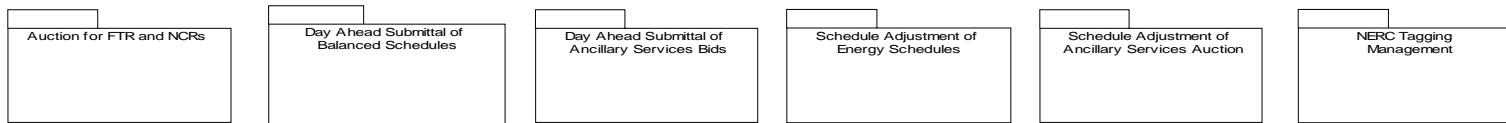

Real-Time Transmission Monitoring and Security Analysis Processes

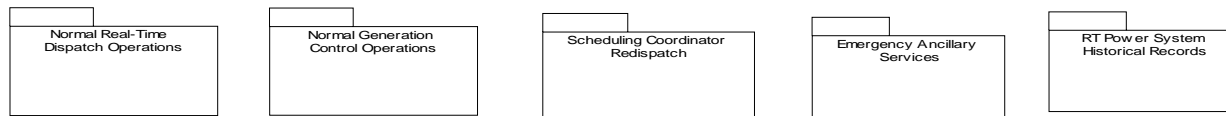

Post-Dispatch Transmission Settlement Processes

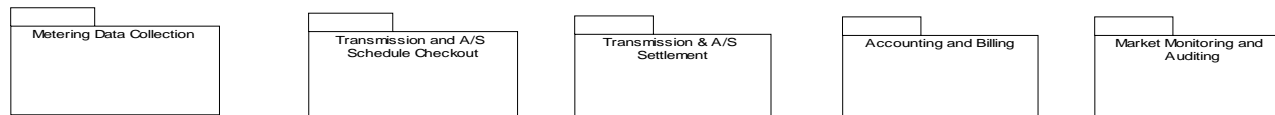

Support Processes

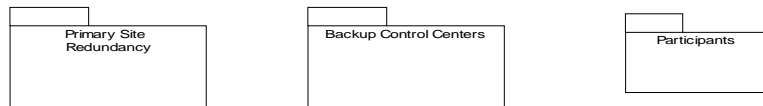

1.5 Actor (Stakeholder) Roles

Describe all the people (their job), systems, databases, organizations, and devices involved in or affected by the Function (e.g. operators, system administrators, technicians, end users, service personnel, executives, SCADA system, real-time database, RTO, RTU, IED, power system). Typically, these actors are logically grouped by organization or functional boundaries or just for collaboration purpose of this use case. We need to identify these groupings and their relevant roles and understand the constituency. The same actor could play different roles in different Functions, but only one role in one Function. If the same actor (e.g. the same person) does play multiple roles in one Function, list these different actor-roles as separate rows.

<i>Grouping (Community)</i>		<i>Group Description</i>
<i>Market Operations</i>		
<i>Actor Name</i>	<i>Actor Type (person, device, system etc.)</i>	<i>Actor Description</i>
Area & Resource Operation Centers	Corporation	
AuditingPersonnel	Person	
DatabaseAdministrator	Person	
DisCos	Corporation	
DistributionSystem	System	
Eligible Customer Metered Entity	Person	
Eligible Customers	Person	
GenCos	Corporation	
IntervalMeterDevice	Device	
LGROwner	Person	
LoadProfile	Database	
MarketParticipant	Person	

<i>Grouping (Community)'</i>		<i>Group Description</i>
<i>Market Operations</i>		
<i>Actor Name</i>	<i>Actor Type (person, device, system etc.)</i>	<i>Actor Description</i>
Metered Entities	Corporation	
WeatherService	Corporation	
NERC	Corporation	
Other 2 RTOs	Corporation	
RetailCos	Corporation	
RTOOperator	Person	
RTOProgrammerEngineerPersonnel	Person	
RTOScheduler	Person	
SC-FTROwner	Person	
SchedulingCoordinator	Person	
SettlementAdministrator	Person	
SettlementDataMgmtAgent	Corporation	
CustomerMeterDevice	Device	
Tag Authority	Corporation	
TimeLineManager	Timer	

<i>Grouping (Community)'</i>		<i>Group Description</i>
<i>Market Operations</i>		
<i>Actor Name</i>	<i>Actor Type (person, device, system etc.)</i>	<i>Actor Description</i>
TransmissionOwner	Person	
TransmissionSystem	Power System	
WSCC	Corporation	

Replicate this table for each logic group.

1.6 Information Exchanged

Describe any information exchanged in this template.

<i>Information Object Name</i>	<i>Information Object Description</i>

1.7 Activities/Services

Describe or list the activities and services involved in this Function (in the context of this Function). An activity or service can be provided by a computer system, a set of applications, or manual procedures. These activities/services should be described at an appropriate level, with the understanding that sub-activities and services should be described if they are important for operational issues, automation needs, and implementation reasons. Other sub-activities/services could be left for later analysis.

<i>Activity/Service Name</i>	<i>Activities/Services Provided</i>

<i>Activity/Service Name</i>	<i>Activities/Services Provided</i>

1.8 Contracts/Regulations

Identify any overall (human-initiated) contracts, regulations, policies, financial considerations, engineering constraints, pollution constraints, and other environmental quality issues that affect the design and requirements of the Function.

<i>Contract/Regulation</i>	<i>Impact of Contract/Regulation on Function</i>
Market Tariff	
Agreements between RTOs	

<i>Policy</i>	<i>From Actor</i>	<i>May</i>	<i>Shall Not</i>	<i>Shall</i>	<i>Description (verb)</i>	<i>To Actor</i>

<i>Constraint</i>	<i>Type</i>	<i>Description</i>	<i>Applies to</i>

2 Step by Step Analysis of Function

Not provided in this overview document

3 Auxiliary Issues

3.1 References and contacts

Documents and individuals or organizations used as background to the function described; other functions referenced by this function, or acting as “sub” functions; or other documentation that clarifies the requirements or activities described. All prior work (intellectual property of the company or individual) or proprietary (non-publicly available) work must be so noted.

ID	Title or contact	Reference or contact information
[1]		
[2]		

3.2 Action Item List

As the function is developed, identify issues that still need clarification, resolution, or other notice taken of them. This can act as an Action Item list.

ID	Description	Status
[1]		
[2]		

3.3 Revision History

For reference and tracking purposes, indicate who worked on describing this function, and what aspect they undertook.

No	Date	Author	Description
0.	February 27, 2004	Frances Cleveland	

This page intentionally left blank.

Wide-Area Control System Advanced Auto-Restoration

1 Descriptions of Function

All prior work (intellectual property of the company or individual) or proprietary (non-publicly available) work should be so noted.

1.1 Function Name

Advanced Auto-Restoration

1.2 Function ID

IECSA identification number of the function

T-4.1,T-4.2,T-4.3,T-4.15,T-6,T-6.10,T-6.17,T-6.19,D-4,D-5,D-6,D-7,L-2.2.1,L-2.2.2,L-3.2,L-3.4,L-3.8,C-9.4

1.3 Brief Description

Describe briefly the scope, objectives, and rationale of the Function.

The purpose of advanced auto-restoration is to automatically restore power to un-faulted sections of a line or feeder, after a fault is isolated, in networks having complex topologies and multiple organizational boundaries.

1.4 Narrative

A complete narrative of the Function from a Domain Expert's point of view, describing what occurs when, why, how, and under what conditions. This will be a separate document, but will act as the basis for identifying the Steps in Section 2.

Currently, automatic restoration of service is performed only within a restricted set of conditions and network topologies, as described in the WAMACS Automated Controls Baseline use case. In the near future, it is expected that these restrictions will be removed and the automation system will be able to restore power in systems which:

- There are multiple sources from which to restore power

- The multiple sources may belong to different organizations
- There are multiple possible connection points between the sources
- It is necessary to split the de-energized load into sections because any one source cannot re-energize the whole load

The remainder of this narrative describes an example scenario illustrating these capabilities.

1.4.1 Initial State

As shown in Figure 1, two neighboring substations are connected in a manner to make traditional auto-restoration possible, in other words:

- Per typical utility operation, there is breaker located in the substation connected to each feeder, provided with an automatic reclosing function. These are labeled 1A1, 1B1, 2A1, and 2B1 in the figure, following the naming convention <substation1/2><feederA/B><switch/breaker#>.
- Normally-closed switches are located at intervals along each feeder to permit auto-sectionalizing around a fault. (e.g. 1B2, 1B3, 1B4). These switches are typically of the “no-load break” variety, for economic reasons. They can open only when there is no load on the line. Some may be of the “load break” variety, which can open under normal current. Usually only those devices at the head of the feeder (such as 1A1, 1B1 etc.) will be “fault interrupting” breakers capable of opening under fault current.
- A normally-open switch is located at the end of adjacent feeders. (e.g. 1C or 2C). This switch can be closed to share load or restore power from one feeder to the other.
- Each breaker and switch is monitored and controlled by an Intelligent Electronic Device (IED).
- A Substation Computer (SC) in each substation gathers information and controls the IEDs connected to its feeders. It reports to the Operator for that utility by way of a Graphical User Interface (GUI).

In this example, the two adjacent sets of feeders can also be connected to each other (if necessary) using a number of normally-open switches (1X, 1Y and 1Z). This interconnection is rarely performed because the two substations belong to different utilities. In this

example, the interconnection switches are owned by the utility that controls Substation 1. However, Operator 1 must have approval from Operator 2 before closing any of these switches.

The scenario begins with each IED reporting its downstream load and switch status to the Substation Computer. For the purposes of this example, we assume that *all* this information is reported to *both* Substation Computers. There are two ways to do this:

- Each IED reports its data separately to each Substation Computer
- Each IED only reports to its “own” Substation Computer, and the Substation Computers exchange information.

The latter case is most likely to be implemented because:

- It reduces the number of communications connections between the two utilities, which is desirable for security reasons.
- It reduces the bandwidth and processing power required by each IED.

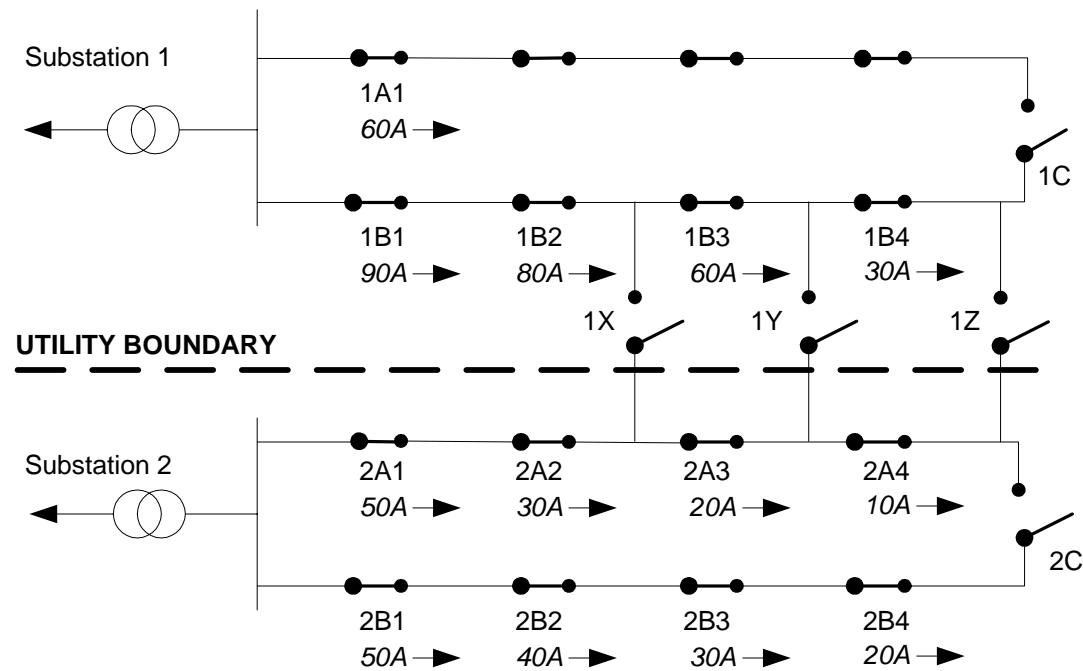

Figure 1 Initial System State

From the current data reported by each IED (shown in italics with arrows), the Substation Computers can calculate the load on each individual section of the feeders. This example assumes that the maximum capacity limit on each feeder is 100A. Feeder 1B, in that case, is operating near capacity, while the other feeders are about 50% loaded.

1.4.2 Fault Detection

As shown in Figure 2, a fault occurs on feeder 1B between switches 1B2 and 1B3. Breaker 1B1 trips and de-energizes 90A of load, including 60A that is downstream from the fault.

All IEDs on feeder 1B report to Substation Computer 1 the fault and the loss of current. Those IEDs that saw the fault current (1B1 and 1B2) may send an estimated distance to the fault. IED 1B1 reports that it has tripped and has started reclosure timers. Substation Computer 1 forwards the information to Substation Computer 2, but SC2 takes no action because the fault is not in its territory.

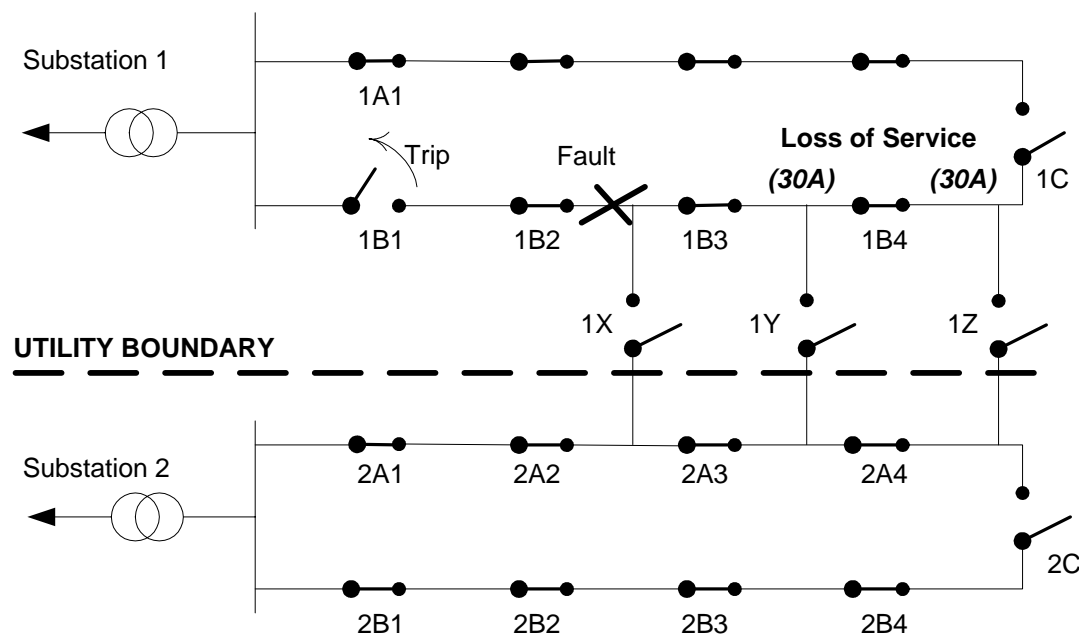

Figure 2 Fault Detection

1.4.3 Auto-Sectionalization

As shown in Figure 4, the IEDs on feeder 1B take action to isolate, or auto-sectionalize, the fault. There are two possible methods for doing so, with different communications requirements.

- **High-Speed Communication.** One possible method is that Substation Computer 1 determines which two switches (1B2 and 1B3) to open using fault direction and distance information provided by the IEDs. This method would require fast communication

between the 1B IEDs and SC1, in order to open the switches between reclosings of the breaker (measured in seconds). It would likely also require the IEDs to provide a specialized communications service, i.e. “open the next time you see zero current”.

- **Fault-Interruption Counting.** A more robust and distributed method would be for each IED to be programmed to open its switch after a pre-configured reclosure attempt. Each IED would open its switch under the following conditions:
 - The IED has observed fault current
 - The IED has seen the fault current drop to zero, indicating the breaker has tripped
 - These two conditions have occurred a pre-configured number of times. The number is different for each IED on the feeder.

Figure 3 illustrates how this occurs in the example. No IED is permitted to open its switch between the initial fault and the first reclosure attempt, in case the fault is transient. 1B4 is permitted to open its switch between the first and second reclosure attempts, but does not do so. Because 1B4 is downstream from the fault and has no other source of current, it does not observe the fault current and its opening conditions are therefore not met. Similarly, 1B3 does not observe fault current and so does not open in its time window.

IED 1B2, however, has seen the same current as 1B1, and has been counting the fault interruptions. After the third reclosure attempt, 1B2 opens its switch, isolating the fault from any source of current. This is **auto-sectionalization**, and is shown as step (1) in Figure 4. When 1B1 recloses the fourth time, it is successful, and 10A of load is restored to that section of feeder 1B. This is step (2) in Figure 4.

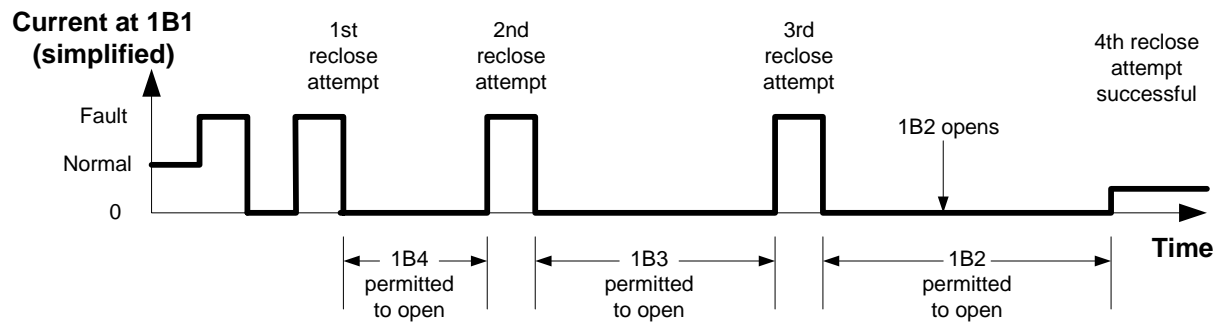

Figure 3 Fault-Interruption Counting for Auto-Sectionalization

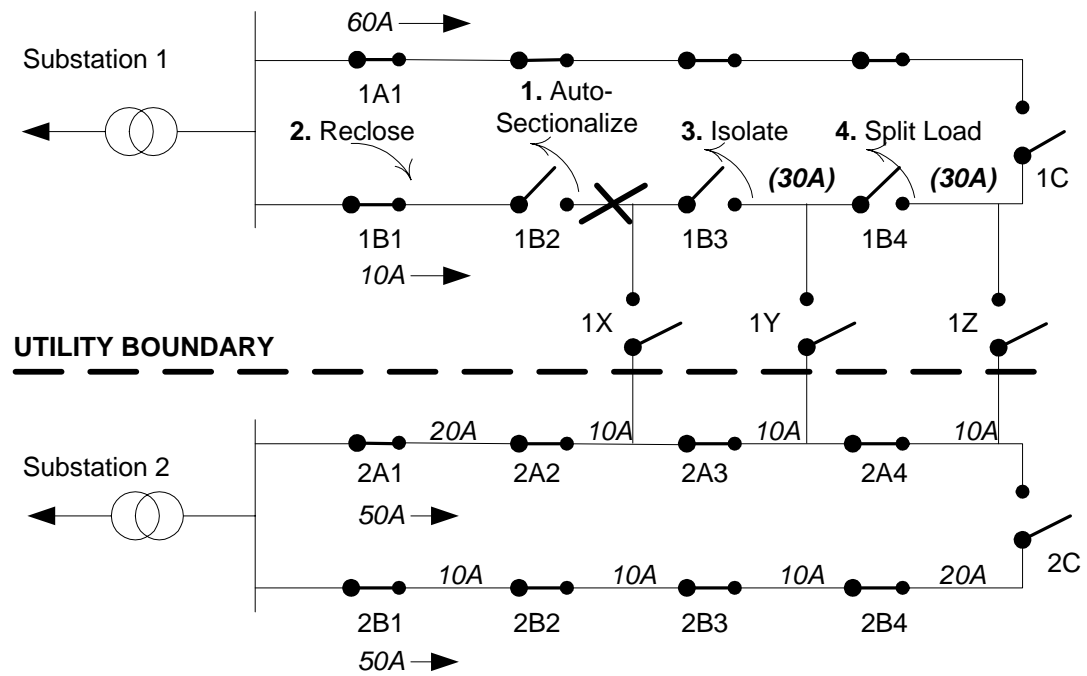

Figure 4 Auto-Sectionalization and Load Splitting

1.4.4 Isolating the Fault

The final step in auto-sectionalization, shown in step (3) of Figure 4, is to isolate the fault. Substation Computer 1 observes that 1B3 and 1B4 have reported zero current and voltage without having reported fault current. It therefore determines (possibly with the assistance of distance-to-fault data from 1B1 and 1B2) that the fault is between 1B2 and 1B3. Substation Computer 1 recommends to Operator 1 that switch 1B3 be opened in order to isolate the fault. Operator 1 confirms this operation, and SC1 sends the message to 1B3 causing it to open.

1.4.5 Load Splitting

Whichever auto-sectionalizing method is used, the fault is now isolated and auto-restoration can begin. Substation Computer 1 reviews the data provided prior to the fault. It calculates the loading on each segment of each feeder, as shown in Figure 4. It determines that there is 60A of load that can be restored.

However, the “traditional” solution, to close switch 1C, will not solve the whole problem. Feeder 1A is already loaded at 60A. If it accepts the whole downstream load of 60A, it will be overloaded, since the example began with the assumption of 100A maximum limit per feeder.

The Substation Computer determines that it will be necessary to “split” the downstream load and re-energize it from multiple sources. Substation Computer 1 recommends to Operator 1 that switch 1B4 be opened, receives confirmation from Operator 1, and opens the switch by sending a message to 1B4. This is step (4) in Figure 4.

1.4.6 Auto-Restoration

The final steps in auto-restoration are shown in Figure 5. Utility 1 has a policy in place that load is to be restored from Utility 1 sources whenever possible. Therefore Substation Computer 1 recommends that switch 1C be closed, rather than, for instance, switch 1Z. Operator 1 confirms this operation and SC1 sends the message to IED 1C, restoring 30A of service.

Substation Computer 1 recommends that switch 1Y be closed to restore the remaining un-faulted section of feeder between 1B3 and 1B4. Operator 1 contacts Operator 2 at Utility 2, requesting permission to close switch 1Y.

Before making this decision, Operator 2 does the following:

- Reviews the sequence of events logs generated by SC2 showing the auto-sectionalizing sequence.
- Confirms that Utility 1 has isolated the fault between 1B2 and 1B3.
- Confirms from records generated by SC2 that the de-energized section between 1B3 and 1B4 previously was loaded at 30A.
- Checks on the SC2 GUI that feeder 2A can handle the additional 30A load.

Finally, Operator 2 contacts Operator 1, giving permission to close switch 1Y. Operator 1 confirms the operation with SC1, which sends the message to 1Y and restores the remaining 30A of service.

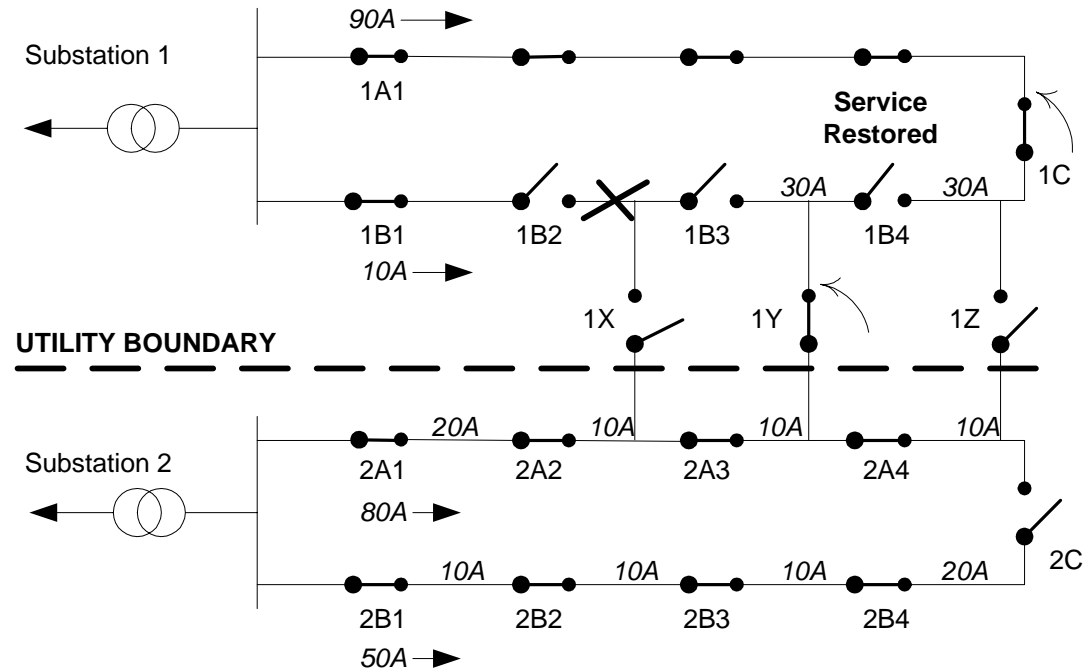

Figure 5 Auto-Restoration

1.4.7 Load Balancing

Following auto-restoration, feeder 1A is loaded at 90A and 2A is loaded at 80A, while 2B is only loaded at 50A. Operator 2 may choose to close switch 2C in order to lighten the load on feeder 2A.

In theory, the whole system could be more efficiently loaded by also closing switch 1Z. However, neither Substation Computer would make this recommendation because:

- The power on the two feeders is likely incompatible due to differences in frequency, voltage, and phase angle. Therefore, it would be necessary to open 1C before closing 1Z.

- Opening 1C would cause a momentary outage downstream of 1B4. Furthermore, if 1C was not a “load break” switch, it would be necessary to first break the load at 1A1, meaning that the outage would occur for all of feeder 1A.
- Utility 1 would lose the 30A of load downstream of 1B4 to Utility 2 until the fault could be repaired. This would be unacceptable from a business point of view.

1.4.8 Summary

Performing advanced auto-restoration will require the following measures beyond those required for existing auto-restoration mechanisms:

- Real-time sharing of data between Substation Computers
- Calculation of loads on each feeder or line section, and storing these recent historical values in the Substation Computer.
- More advanced logic in each Substation Computer to evaluate each possible switching action, perhaps on the order of the Contingency Analysis programs currently used by EMS stations.
- Reliable communications between neighboring operators, either by voice or by data
- One of the following features:
 - **Full breakers and protection relays on each section**, or “load break” or “fault-interrupting” switches. Utilities are unlikely to do this because of the significantly higher cost.
 - **Fault-Interruption counting**, as discussed in this example. Fault-interruption counting has one major drawback: Ideally, it requires the same number of reclosures as there are switches on the feeder. Typically, utilities do not use a high number of reclosures because:

- It causes excessive wear on the breaker
- It annoys the customers, who see multiple small outages within a short period of time.

Therefore it is rare to see more than two or three reclosures. This example, with four reclosures, would be extremely rare. This limits the granularity with which load can be restored, and increases the number of subscribers affected by an fault.

- o **High-speed communications** between remote IEDs and the substation computer. In this example, it would permit the Substation Computer to immediately determine that 1B2 and 1B3 switches should open, and do so quickly, between the first and second reclosings of breaker1B1. This is shown as an alternate scenario in the use case below.

1.5 Actor (Stakeholder) Roles

Describe all the people (their job), systems, databases, organizations, and devices involved in or affected by the Function (e.g. operators, system administrators, technicians, end users, service personnel, executives, SCADA system, real-time database, RTO, RTU, IED, power system). Typically, these actors are logically grouped by organization or functional boundaries or just for collaboration purpose of this use case. We need to identify these groupings and their relevant roles and understand the constituency. The same actor could play different roles in different Functions, but only one role in one Function. If the same actor (e.g. the same person) does play multiple roles in one Function, list these different actor-roles as separate rows.

<i>Grouping (Community)</i>		<i>Group Description</i>
<i>Advanced Auto-Restoration</i>		<i>The actors involved in restoring service in an example scenario involving multiple power sources, multiple organizations, and load splitting.</i>
<i>Actor Name</i>	<i>Actor Type (person, device, system etc.)</i>	<i>Actor Description</i>
Utility 1, Utility 2	Organizations	Neighboring utilities with interconnections and agreements on auto-restoration. Apply policies that affect the auto-restoration algorithms on the SubstationComputerDevices
SystemOperator 1,	Persons	Control the SubstationComputerDevices. Confirm or reject auto-restoration

<i>Grouping (Community)</i>		<i>Group Description</i>
<i>Advanced Auto-Restoration</i>		<i>The actors involved in restoring service in an example scenario involving multiple power sources, multiple organizations, and load splitting.</i>
<i>Actor Name</i>	<i>Actor Type (person, device, system etc.)</i>	<i>Actor Description</i>
SystemOperator 2		recommendations made by the SubstationComputerDevices
SubstationComputerDevice 1, SubstationComputerDevice 2	Devices	Apply algorithms to implement auto-restoration based on data gathered from the IEDs.
IED	Devices	IED <substation 1 or 2> <feeder A or B> <device ID number> Gather data from feeders and operate switches based on controls from the SubstationComputerDevices. The first IED on each feeder controls a “fault-interrupting” breaker with auto-reclosing function. The other IEDs control “no-load break” switches.
External	Event	Causes a fault.
System	Devices	The combined power network.

Replicate this table for each logic group.

1.6 Information exchanged

Describe any information exchanged in this template.

<i>Information Object Name</i>	<i>Information Object Description</i>
Switch State	Digital Input with value Open or Closed. The change of state of a switch. Includes: a point number, the quality of the point (online/offline or valid/invalid), the new state, the time the state changed, typically accurate to millisecond resolution.
Current	Analog value in Amperes. Often a twelve-bit or sixteen-bit integer that must be scaled for display in engineering units. Includes: a point number, the quality of the point, and the value. May or may not include a millisecond timestamp.
Voltage	Analog value in Volts. Often a twelve-bit or sixteen-bit integer that must be scaled for display in engineering units. Includes: a point number, the quality of the point, and the value. May or may not include a millisecond timestamp.
Trip	Digital Input with value Trip. A particular type of Switch State change that indicates through its point number that a breaker has tripped and is now open. Includes all the same data as for a Switch State change.
Fault Detected	Digital Input with value True or False. Indicates an IED has observed fault current. Includes: a point number, the quality of the point, the new state, millisecond timestamp. May also include an analog value indicating a calculated Distance to Fault.
No Current Detected	Digital Input with value True or False. Indicates an IED cannot detect any current. Includes: a point number, the quality of the point, the new state, millisecond timestamp. May not be sent as a separate indication because SubstationComputerDevice can determine it from the Current transmitted.
No Voltage Detected	Digital Input with value True or False. Includes: a point number, the quality of the point, the new state, millisecond timestamp. May not be sent as a separate indication because SubstationComputerDevice can determine it from the Voltage transmitted.
Switch Control	Digital Output with value Open or Close. Sent by the SubstationComputerDevice to change the state of a switch. Includes a point number and the requested switch state.
Request	Message to an SystemOperator, requesting that a particular action be taken, e.g. opening a particular switch. Includes: the operation to be taken (e.g. trip, close), and the location (e.g. the device name or

<i>Information Object Name</i>	<i>Information Object Description</i>
	feeder location). May be graphical, text, or voice.
Confirm	Confirmation from an SystemOperator to a SubstationComputerDevice that the requested operation can proceed.

1.7 Activities/Services

Describe or list the activities and services involved in this Function (in the context of this Function). An activity or service can be provided by a computer system, a set of applications, or manual procedures. These activities/services should be described at an appropriate level, with the understanding that sub-activities and services should be described if they are important for operational issues, automation needs, and implementation reasons. Other sub-activities/services could be left for later analysis.

<i>Activity/Service Name</i>	<i>Activities/Services Provided</i>
Fault Detection	Identify that a fault has occurred and where it is located.
Auto-Sectionalization	Open switch(es) upstream of a fault to permit restoration of service
Fault Isolation	Open switch(es) downstream of a fault to prevent a repeated fault when service is restored. May be considered a sub-function of auto-sectionalization.
Load Splitting	Open switch(es) within a de-energized area, permitting some of the load in that area to be re-energized from different sources.
Auto-Restoration	Close switch(es) to re-apply power to a de-energized area.
Load Balancing	Open or close switch(es) to divide load between different sources and reduce load on any one source.

1.8 Contracts/Regulations

Identify any overall (human-initiated) contracts, regulations, policies, financial considerations, engineering constraints, pollution constraints, and other environmental quality issues that affect the design and requirements of the Function.

<i>Contract/Regulation</i>	<i>Impact of Contract/Regulation on Function</i>
Cost of “fault-interrupting” switches and breakers	Prevents installing these devices at more than one location on the feeder. Requires auto-restoration algorithms to be based around opening switches only when there is no load on the line.
Competition between neighboring utilities	Requires auto-restoration algorithms to be biased against restoring load using power from neighboring utilities.

<i>Policy</i>	<i>From Actor</i>	<i>May</i>	<i>Shall Not</i>	<i>Shall</i>	<i>Description (verb)</i>	<i>To Actor</i>
Use Local Power First	Utility			X	Restore power using sources from the local utility first before considering sources from other utilities.	SubstationComputerDevice
Maximum Current Limits	Utility		X		Exceed maximum current limit on any feeder	SubstationComputerDevice
“No-Load Break” Switches	Utility		X		Open switches that are under load	SubstationComputerDevice
Incompatible Feeders	Utility		X		Connect feeders that are powered by different sources and therefore have different voltage, frequency and phase angle characteristics.	SubstationComputerDevice
Permission to Link Utilities	Utility		X		Close switches linking utilities until permission is obtained from the other SystemOperator	SystemOperator
Minimum Outage	Utility			X	Minimize the length of any outage	SystemOperator and SubstationComputerDevice
Minimum Reclosing	Utility			X	Minimize the frequency and number of reclosures	SystemOperator and SubstationComputerDevice

<i>Constraint</i>	<i>Type</i>	<i>Description</i>	<i>Applies to</i>

2 Step by Step Analysis of Function

Describe steps that implement the function. If there is more than one set of steps that are relevant, make a copy of the following section grouping (Preconditions and Assumptions, Steps normal sequence, and Steps alternate or exceptional sequence, Post conditions)

2.1 Steps to implement function

Advanced Auto-Restoration

See section 2.3 for a diagram of the steps that are described in this section. This scenario illustrates the “high-speed communications” option described in the Narrative.

2.1.1 Preconditions and Assumptions

Describe conditions that must exist prior to the initiation of the Function, such as prior state of the actors and activities

Identify any assumptions, such as what systems already exist, what contractual relations exist, and what configurations of systems are probably in place

Identify any initial states of information exchanged in the steps in the next section. For example, if a purchase order is exchanged in an activity, its precondition to the activity might be ‘filled in but unapproved’.

<i>Actor/System/Information/Contract</i>	<i>Preconditions or Assumptions</i>
IEDs	Regularly sending existing Current, Voltage, and Switch States to SubstationComputerDevice 1.
SubstationComputerDevice 1	Regularly sending existing Current, Voltage, and Switch States to SubstationComputerDevice 2.
System	No faults existing.

2.1.2 Steps – Normal Sequence

Describe the normal sequence of events, focusing on steps that identify new types of information or new information exchanges or new interface issues to address. Should the sequence require detailed steps that are also used by other functions, consider creating a new “sub” function, then referring to that “subroutine” in this function. Remember that the focus should be less on the algorithms of the applications and more on the interactions and information flows between “entities”, e.g. people, systems, applications, data bases, etc. There should be a direct link between the narrative and these steps.

The numbering of the sequence steps conveys the order and concurrency and iteration of the steps occur. Using a Dewey Decimal scheme, each level of nested procedure call is separated by a dot ‘.’. Within a level, the sequence number comprises an optional letter and an integer number. The letter specifies a concurrent sequence within the next higher level; all letter sequences are concurrent with other letter sequences. The number specifies the sequencing of messages in a given letter sequence. The absence of a letter is treated as a default 'main sequence' in parallel with the lettered sequences.

Sequence 1:

1.1 - Do step 1
1.2A.1 - In parallel to activity 2 B do step 1
1.2A.2 - In parallel to activity 2 B do step 2
1.2B.1 - In parallel to activity 2 A do step 1
1.2B.2 - In parallel to activity 2 A do step 2
1.3 - Do step 3
1.3.1 - nested step 3.1
1.3.2 - nested step 3.2

Sequence 2:

2.1 - Do step 1
2.2 - Do step 2

#	Event	Primary Actor	Name of Process/Activity	Description of Process/Activity	Information Producer	Information Receiver	Name of Info Exchanged	Additional Notes	IECSA Environments
#	Triggering event? Identify the name of the event. ¹	What other actors are primarily responsible for the Process/Activity? Actors are defined in section 1.5.	Label that would appear in a process diagram. Use action verbs when naming activity.	Describe the actions that take place in active and present tense. The step should be a descriptive noun/verb phrase that portrays an outline summary of the step. "If ...Then...Else" scenarios can be captured as multiple Actions or as separate steps.	What other actors are primarily responsible for Producing the information? Actors are defined in section 1.5.	What other actors are primarily responsible for Receiving the information? Actors are defined in section 1.5. (Note – May leave blank if same as Primary Actor)	Name of the information object. Information objects are defined in section 1.6	Elaborate architectural issues using attached spreadsheet. Use this column to elaborate details that aren't captured in the spreadsheet.	Reference the applicable IECSA Environment containing this data exchange. Only one environment per step.
1A	Fault	External	Report Fault	IEDs upstream from the fault report seeing fault current	IED 1B1, IED 1B2	SubstationComputerDevice 1	Fault Detected		Deterministic Rapid Response Intra-Sub
1B	Loss of current and voltage	External	Report Loss of Service	IEDs downstream from the fault report loss of current and voltage	IED 1B3, IED 1B4	SubstationComputerDevice 1	No Current Detected, No Voltage Detected		Deterministic Rapid Response Intra-Sub
2.1		IED 1B1	Initial Trip	First feeder IED (relay) trips breaker and reports the action. Starts reclosure timer.	IED 1B1	SubstationComputerDevice 1	Trip		Deterministic Rapid Response Intra-Sub
2.2	Recloser timer expires	IED 1B1	First Reclose Attempt	Upon expiry of reclosure timer, first IED recloses the breaker. Reports the action.	IED 1B1	SubstationComputerDevice 1	Switch State (close)		Deterministic Rapid Response Intra-Sub

¹ Note – A triggering event is not necessary if the completion of the prior step – leads to the transition of the following step.

#	Event	Primary Actor	Name of Process/Activity	Description of Process/Activity	Information Producer	Information Receiver	Name of Info Exchanged	Additional Notes	IECSA Environments
2.3	Fault	External	Report Fault	IEDs upstream from the fault report seeing fault current again. This message indicates that the fault was not intermittent and that the SC should attempt to auto-sectionalize.	IED 1B1, IED 1B2	SubstationComputerDevice 1	Fault Detected		Deterministic Rapid Response Intra-Sub
2.4		IED 1B1	2 nd Trip	First IED trips breaker and reports the action. Starts reclosure timer. This message indicates that the SC can now attempt to open a switch for auto-sectionalization.	IED 1B1	SubstationComputerDevice 1	Trip		Deterministic Rapid Response Intra-Sub
2.5		SubstationComputerDevice 1	Auto-sectionalize	Computer determines the correct switch to open based on the fact that the upstream switches reported fault current, while the downstream switches reported no current or voltage. Directs the correct switch to open between reclosures of the breaker.	SubstationComputerDevice 1	IED 1B2	Switch Control (open)	Time constrained. Must occur between 2 nd Trip and 2 nd Reclose.	Deterministic Rapid Response Intra-Sub

#	Event	Primary Actor	Name of Process/Activity	Description of Process/Activity	Information Producer	Information Receiver	Name of Info Exchanged	Additional Notes	IECSA Environments
2.6	Reclosure timer expires	IED 1B1	Report Upstream Power Restored	Upon expiry of the reclosure timer, first feeder IED recloses the breaker. Reports the action. Power is now restored from the substation to switch 1B1.	IED 1B1	SubstationComputerDevice 1	Switch State (close), Current, Voltage		Deterministic Rapid Response Intra-Sub
3.1	Logic timer expires	SubstationComputerDevice 1	Request Isolation	Computer detects (using a timer) that no fault has occurred since 1B1 reclosed the breaker. Determines that switch 1B3 is the first switch downstream from the fault and should be opened. Requests confirmation from SystemOperator.	SubstationComputerDevice 1	SystemOperator 1	Request (open 1B1)		User Interface
3.2		SystemOperator 1	Confirm Isolation	Tells the SubstationComputerDevice it is permitted to open the first downstream switch (1B3).	SystemOperator 1	SubstationComputerDevice 1	Confirm		User Interface
3.3		SubstationComputerDevice 1	Isolate Fault	Requests that the first downstream switch (1B3) open.	SubstationComputerDevice 1	IED 1B3	Switch Control (open)		Deterministic Rapid Response Intra-Sub

#	Event	Primary Actor	Name of Process/Activity	Description of Process/Activity	Information Producer	Information Receiver	Name of Info Exchanged	Additional Notes	IECSA Environments
3.4		IED 1B3	Report Isolation Complete	The IED controlling the first downstream switch reports that the switch is open.	IED 1B3	SubstationComputerDevice 1	Switch State (open)		Deterministic Rapid Response Intra-Sub
4.1		SubstationComputerDevice 1	Request Load Split	Computer determines from the Current and Voltage information stored prior to the fault that service cannot be restored from a single source. Determines which switch to operate (1B4) and requests confirmation from the SystemOperator.	SubstationComputerDevice 1	SystemOperator 1	Request (open 1B4)		User Interface
4.2		SystemOperator 1	Confirm Load Split	SystemOperator confirms that the Computer may open the switch to split the load (1B4)	SystemOperator 1	SubstationComputerDevice 1	Confirm		User Interface
4.3		SubstationComputerDevice 1	Split Load	Computer opens the switch to split the load (1B4)	SubstationComputerDevice 1	IED 1B4	Switch Control (open)		Deterministic Rapid Response Intra-Sub
4.4		IED 1B4	Report Load Split Complete	IED (1B4) reports that the switch is open and the load is split.	IED 1B4	SubstationComputerDevice 1, SubstationComputerDevice 2	Switch State		Deterministic Rapid Response Intra-Sub

#	Event	Primary Actor	Name of Process/Activity	Description of Process/Activity	Information Producer	Information Receiver	Name of Info Exchanged	Additional Notes	IECSA Environments
5.1		SubstationComputerDevice 1	Request Local Restoration	Computer determines that half the load can be restored by closing the local normally open switch (1C), and requests permission from operator.	SubstationComputerDevice 1	SystemOperator 1	Request (close 1C)		User Interface
5.2		SystemOperator 1	Confirm Local Restoration	SystemOperator confirms that the Computer may close the normally open switch (1C)	SystemOperator 1	SubstationComputerDevice 1	Confirm		User Interface
5.3		SubstationComputerDevice 1	Restore from Local Source	Computer closes the switch to restore power from the local source (1C).	SubstationComputerDevice 1	IED 1C	Switch Control (close)		Deterministic Rapid Response Intra-Sub
5.4		IED 1B4	Local Restoration Complete	IED (1C) reports that the switch is closed and current is restored to half the load.	IED 1B4	SubstationComputerDevice 1, SubstationComputerDevice 2	Switch State (close), Current		Deterministic Rapid Response Intra-Sub
6.1		SubstationComputerDevice 1	Request Inter-Utility Restoration	Computer determines that the other half of the load can be restored by closing the inter-utility switch (1Y), and requests permission from operator.	SubstationComputerDevice 1	SystemOperator 1	Request (close 1Y)		User Interface

#	Event	Primary Actor	Name of Process/Activity	Description of Process/Activity	Information Producer	Information Receiver	Name of Info Exchanged	Additional Notes	IECSA Environments
6.2		SystemOperator 1	Request Linking Utilities	SystemOperator 1 verifies Computer 1's request and forwards it to SystemOperator 2 at the other utility.	SystemOperator 1	SystemOperator 2	Request (close 1Y)		User Interface
6.3		SystemOperator 2	Confirm Linking Utilities	SystemOperator 2 verifies the request and gives SystemOperator 1 permission to proceed.	SystemOperator 2	SystemOperator 1	Confirm		User Interface
6.4		SystemOperator 1	Confirm Inter-Utility Restoration	SystemOperator confirms that the Computer may close the normally open inter-utility switch (1Y)	SystemOperator 1	SubstationComputerDevice 1	Confirm		User Interface
6.5		SubstationComputerDevice 1	Restore from Inter-Utility Source	Computer closes the switch to restore power from the other utility source (1Y).	SubstationComputerDevice 1	IED 1Y	Switch Control (close)		Deterministic Rapid Response Intra-Sub
6.6		IED 1Y	Inter-Utility Restoration Complete	IED (1Y) reports that the switch is closed and current is restored to the remaining load.	IED 1Y	SubstationComputerDevice 1, SubstationComputerDevice 2	Switch State (close), Current		Deterministic Rapid Response Intra-Sub

2.1.3 Steps – Alternative / Exception Sequences

Describe any alternative or exception sequences that may be required that deviate from the normal course of activities. Note instructions are found in previous table.

#	Event	Primary Actor	Name of Process/Activity	Description of Process/Activity	Information Producer	Information Receiver	Name of Info Exchanged	Additional Notes	IECSA Environments

2.1.4 Post-conditions and Significant Results

Describe conditions that must exist at the conclusion of the Function. Identify significant items similar to that in the preconditions section.

Describe any significant results from the Function

<i>Actor/Activity</i>	<i>Post-conditions Description and Results</i>
System	No faults remaining, service restored to all but the faulted section.

2.2 Architectural Issues in Interactions

Elaborate on all architectural issues in each of the steps outlined in each of the sequences above. Reference the Step by number.



Microsoft Excel
Worksheet

2.3 Diagram

For clarification, draw (by hand, by Power Point, by UML diagram) the interactions, identifying the Steps where possible.

The following two diagrams illustrate the steps that are described in section 2.1. These diagrams show the message flow. Refer to the Narrative for a text description and diagrams showing the behavior of the physical system.

The scenario shows the “high-speed communications” option described in the Narrative.

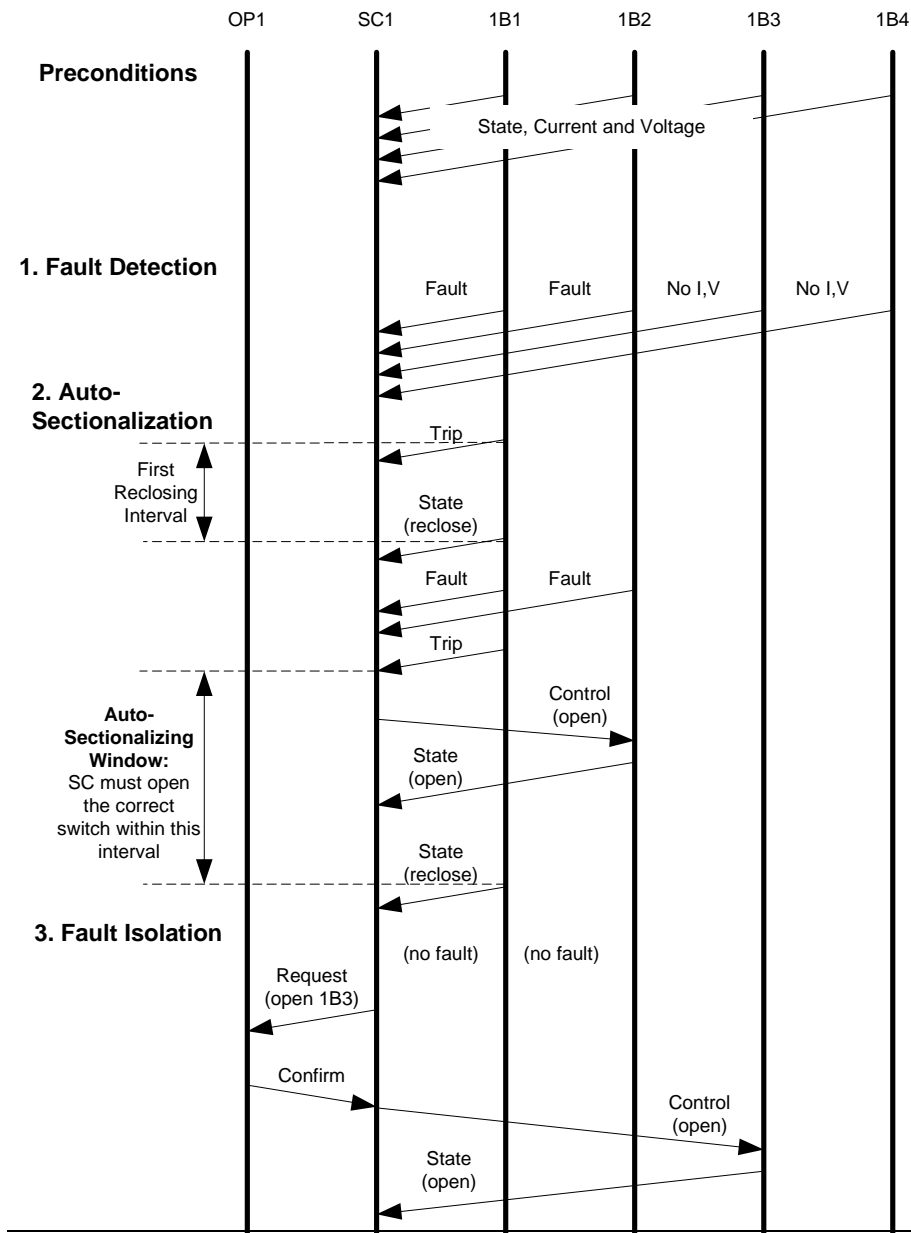

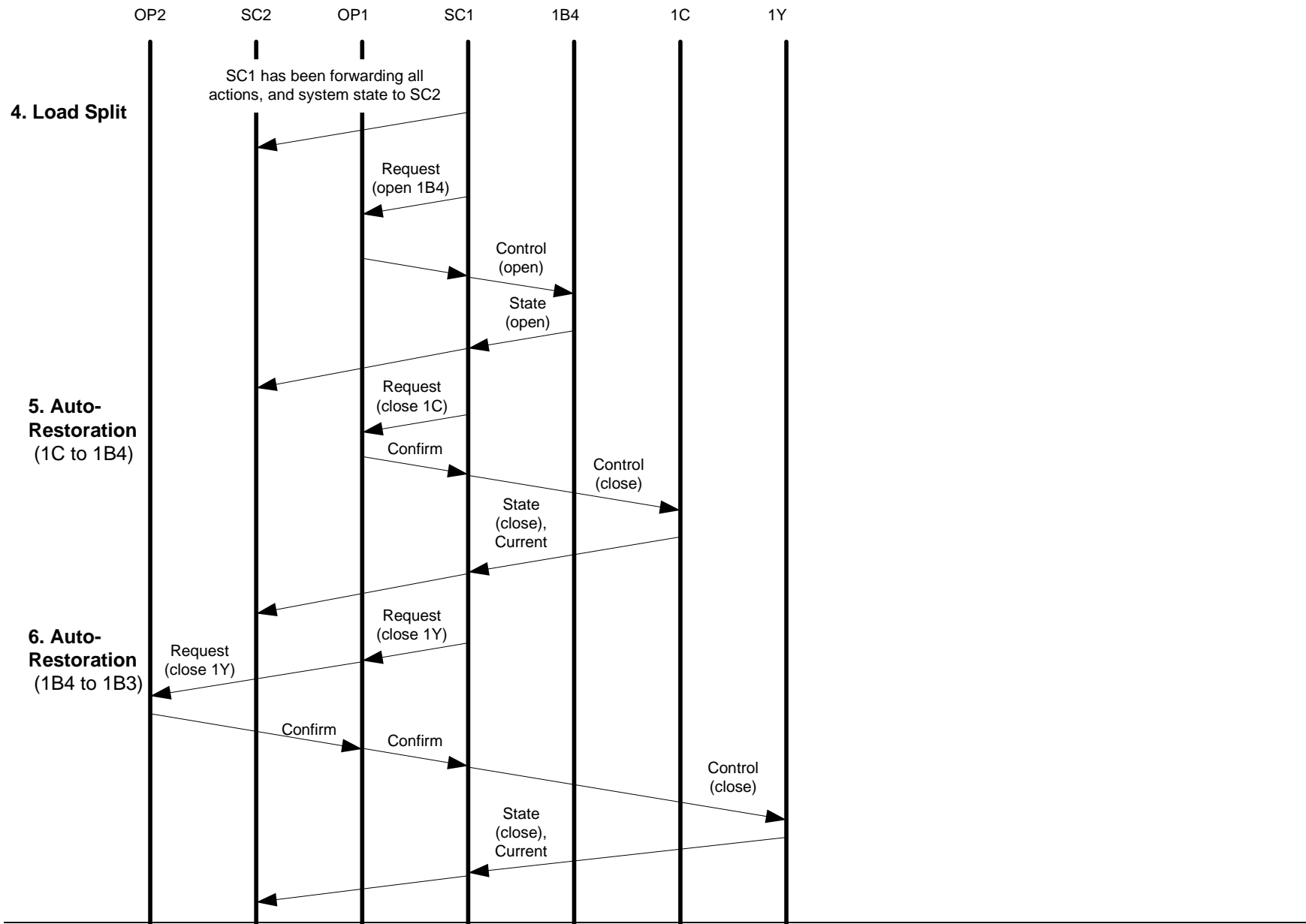

3 Auxiliary Issues

3.1 References and contacts

Documents and individuals or organizations used as background to the function described; other functions referenced by this function, or acting as “sub” functions; or other documentation that clarifies the requirements or activities described. All prior work (intellectual property of the company or individual) or proprietary (non-publicly available) work must be so noted.

ID	Title or contact	Reference or contact information
[1]	Danny Wong	GE Power Systems
[2]	Jim McGhee	GE Power Systems

3.2 Action Item List

As the function is developed, identify issues that still need clarification, resolution, or other notice taken of them. This can act as an Action Item list.

ID	Description	Status
[1]		
[2]		

3.3 Revision History

For reference and tracking purposes, indicate who worked on describing this function, and what aspect they undertook.

No	Date	Author	Description
0.			

This page intentionally left blank.

Wide-Area Monitoring And Control – Automated Control Functions

1 Descriptions of Function

All prior work (intellectual property of the company or individual) or proprietary (non-publicly available) work should be so noted.

1.1 Function Name

Name of Function

Wide Area Monitoring and Control – Automated Control Functions

1.2 Function ID

IECSA identification number of the function

T-4,T-4.1,T-4.2,T-4.3,T-4.18,T-4.19,T-6.5,T-6.10,T-6.21,D-5,L-2.2.1,L-2.2.2,L-2.4,L-3.2,L-3.4,L-3.6,L-3.8,C-9.4

1.3 Brief Description

Describe briefly the scope, objectives, and rationale of the Function.

WAMACS Automated Control describes a set of functions that are typically automated within a substation, but are not directly associated with protection, fault handling, or equipment maintenance. In general, they serve to optimize the operation of the power system and ensure its safe operation by preventing manually generated faults. These functions include:

- Changing transformer taps to regulate system voltage
- Switching capacitor banks or shunts in and out of the system to control voltage and reactive load
- Interlocking of controls to prevent unsafe operation
- Sequencing controls to ensure safe operation
- Load balancing of feeders and transmission lines to reduce system wear and resistive losses

- Restoring service quickly in the event of a fault, with or without operator confirmation

1.4 Narrative

A complete narrative of the Function from a Domain Expert's point of view, describing what occurs when, why, how, and under what conditions. This will be a separate document, but will act as the basis for identifying the Steps in Section 2.

The functions described in this use case were traditionally performed by individual devices acting alone. When implemented this way, they did not have any effect on the communications system. However, in the last five to seven years, these functions have been distributed across the substation. That is, the software logic controlling the function now often resides on a different device than the one which provides the inputs or outputs to the process.

This change has taken place because the use of substation LANs has made it economical to place Intelligent Electronic Devices (IEDs) close to the equipment they are monitoring and controlling. Logic has therefore either been centralized, with a single Substation Computer using the IEDs as remote controllers, or it has been distributed among the IEDs themselves. In either case, the communications system has now become part of the automation functions.

1.4.1 Voltage Regulation using Tap Changers

In voltage regulation, the automation system ensures a constant voltage on the substation bus by adjusting the tap of one or more transformers. A monitoring IED provides a voltage value to the Substation Computer, which has been programmed with threshold and hysteresis logic. The IED is usually monitoring the bus side of a transformer. In more complex situations, IEDs may monitor multiple voltages throughout the station and pass them all to the Substation Computer as input to the logic. When the logic indicates that the bus voltage must be adjusted, the Substation Computer issues a control operation to the IED connected to the transformer tap. This will change the monitored voltage, which will be fed back through the logic.

The voltage control logic typically has a pre-programmed qualification delay in the tens of seconds – adjusting the tap causes wear on the equipment, so adjustments should not be made lightly. Therefore, an appropriate update time for the monitored voltage is on the order of one-half second to one second. Because of the wear on the transformer and tap, and the impact on the rest of the system if adjusted wildly, tap raise/lower operations are typically performed with select-before-operate logic. Redundancy and reliability of the communications path is important.

1.4.2 Volt/VAR Regulation using Capacitor or Shunt Control

In capacitor bank control, the automation system optimizes the voltage and inductive load on a line or bus by connecting or disconnecting one or more capacitor banks. It prevents the imaginary part of the load from becoming too large, reducing voltage and the efficiency of the system. The banks may be widely located across the power system, or within the substation. There are many different logic algorithms for performing capacitor bank control. The simplest is calendar or time of day control, in which the load on the power system is not even monitored. The logic simply assumes that the inductive load will be higher at certain times of the day or year. In areas where inductive load is largely caused by air conditioning, logic may switch based on ambient temperature. Some algorithms monitor voltage only and switch when it passes certain thresholds. More sophisticated algorithms monitor both current and voltage and switch based on either the calculated power factor or directly on the calculated inductive load (VARs). There are typically hysteresis settings on such logic to prevent frequent switching. Shunt control occurs under similar conditions, but with the addition or removal of inductive loads.

In distributed Volt/VAR control, one IED controls one capacitor bank on a given line, and each IED makes switching decisions individually. In centralized Volt/VAR control, each IED reports monitored values back to a Substation Computer. The Substation Computer may make switching decisions based on averages or groupings of voltages. When it decides a switch is necessary, it sends a control message to the appropriate IED, which may or may not be the device reporting the controlled measurements.

The hysteresis in some Volt/VAR algorithms may often be in hours, so communication delays in tens of seconds are easily acceptable. It is fairly common to broadcast capacitor bank control messages, without any select-before-operate logic, since the effect of any given control is usually small. When capacitor banks are located remotely, pagers have sometimes been used as a communications media – one number to switch the bank in, one to disconnect it.

1.4.3 Interlocking

Interlocking prevents unsafe operation of the various switches and breakers within a substation. When an Operator or software application attempts to operate a control, the automation system evaluates the state of the entire system and may reject the control request based on pre-programmed logic. This logic corresponds directly to the topology and interconnection of the substation. Simpler substations may have little or no interlocking. The most complex logic is associated with complex transformer and bus redundancy systems.

For instance, an operator will close an earthing switch on a section of the bus to ground it prior to permitting maintenance on the equipment. However, the operator may not be aware that the bus section is still live due to an interconnection with another bus section or a feeder fed by another bus section. The automation system must prevent a fault by rejecting the Operator's request.

Interlocking is most reliably and efficiently performed by the device that must perform the requested operation. In the past, it may have been performed by the substation GUI or SCADA master station, when those were the only locations that could perform switching. It is still often

performed by a Substation Computer or Data Concentrator which serves as a clearinghouse for all control operations to the substation. This centralized logic mechanism is still used, especially because deregulation has increased the number of master stations that require access to the substation.

However, more and more frequently, interlocking is performed by logic on the IEDs themselves, operating on data distributed by peer-to-peer communications between the devices. This peer-to-peer communications has been made possible by the introduction of the substation LAN. Performing interlocking at the IED permits the same logic and performance to be in effect regardless of whether the control request originates at a remote site, at a substation GUI, at the control panel of the IED, or even a manual panel switch.

In an ideal system, the state information required to perform interlocking would be updated simultaneously throughout the system. Any delay provides a window in which a control could be mis-operated. However, in practice, it is sufficient to update the state of the system in less than a second or two. This interval represents the typical time between the moment an Operator checks the state of the system on a GUI or display panel, and the moment the Operator makes the control request. As more automation applications are deployed in the substation, human reaction time will become less of a factor, and the demands on interlocking will increase. Today, a challenging interlocking requirement for an advanced substation is less than 200 milliseconds between updates.

The control itself is typically issued with select-before-operate logic. The distribution of state information for interlocking may be broadcast or multicast. Redundancy and reliability is extremely important.

1.4.4 Sequenced Controls

While interlocking is intended to prevent Operator-initiated faults by rejecting invalid controls, sequenced controls automate some portion of the Operator's tasks to eliminate the possibility of an invalid control ever being issued.

For example, consider a substation with two transformers and a normally open switch between the two bus sections connected to each transformer. There are two different philosophies that an Operator may employ to take one of the transformers out of service. In "make before break", the Operator should (1) connect the two buses, (2) disconnect the transformer from the bus, and (3) disconnect the transformer from the upstream transmission line. This method ensures there will be no outage of service. In "break before make", however, the Operator should (A) disconnect the transformer, then (B) quickly connect the bus and then (C) disconnect the transmission line. This results in an outage, but prevents side effects resulting from mis-matched transformers sharing the same bus.

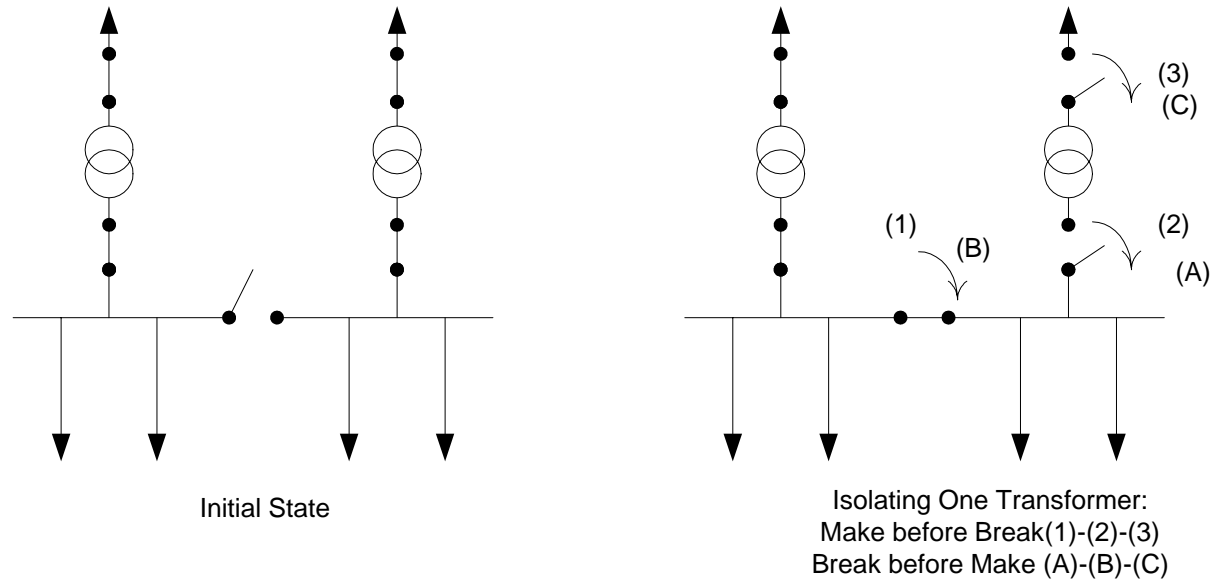

In a sequenced control, the Operator simply requests the isolation of the transformer, and the automation system performs the controls in the sequence required by the utility. The Operator is not permitted to perform any other sequence. In the “break before make” case above, it also ensures that the resulting outage is as small as possible, because the automation system can perform the sequence faster than a human.

The speed of a sequenced control is related to the components involved in the sequence. For instance, the logic may need to wait for motorized switches to connect or disconnect before proceeding with the next control in the sequence. In a “break before make” sequence as described above, however, the length of the outage must be minimized and a value of less than half a second is typically desired. All sequenced controls are typically service-affecting and are therefore executed with select-before-operate logic.

1.4.5 Load Balancing

Load balancing is typically a distribution operation, performed between two transformers within a substation, but may also be performed in transmission systems between substations. In the distribution case, two feeders serviced by separate transformers are connected at their remote ends by a normally open switch. A pole-top IED controls the switch. Other IEDs monitor load on the line. The IEDs report the state and load of the system to a Substation Computer. The Substation Computer detects the condition when one transformer is heavily loaded and the other has excess capacity, and sends a message to the pole-top IED to close the switch. Now, instead of one line loaded at 90% and the other at 25%, both

may be loaded at 50%. Since resistive losses vary with the square of the current, this action improves the efficiency of the power system and reduces wear on equipment. In transmission systems, two substations having lines feeding the same third substation may share load. This type of logic is typically centralized, not distributed.

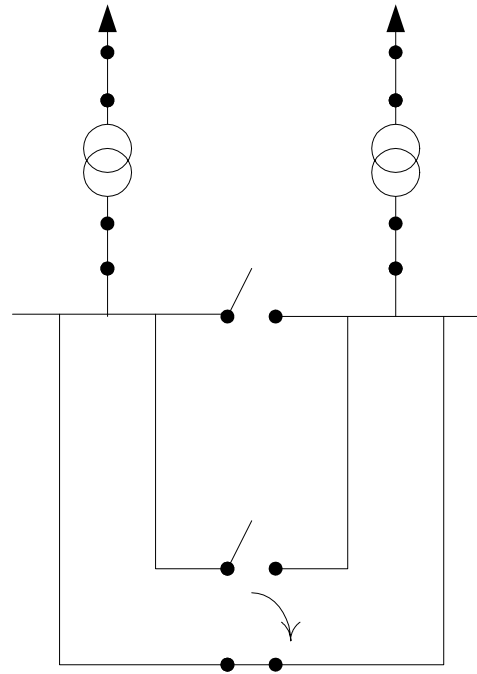

As with tap changing, load balancing is not an action that is typically performed lightly. Qualification times for the logic may be measured in minutes or even hours. Therefore, update times and control transmission times may be measured in seconds. In distribution operations, this is fortunate because IEDs controlling the switches may be remote and only reached via slow links. Some utilities may prefer that the process not be completely automated, and that the automation system request confirmation from the Operator before taking action. Reliability of the data is important and redundant links may be used.

1.4.6 Automated Service Restoration

Automated Service Restoration is typically a distribution operation, but may be performed in transmission systems when “loops” are possible between substations. In the distribution case, two feeders are connected at their remote ends by a normally open switch. Several other switch /

breaker combinations are located at other points along the feeders. All the switches and breakers are monitored by IEDs. When a fault occurs, the IEDs on the upstream side of the fault trips its breaker. It notifies the Substation Computer of its action. The IED on the downstream side of the fault notifies the Substation Computer of the loss of current and estimates the direction of the fault. Based on that information and pre-configured logic, the Substation Computer recommends to the Operator that the breaker of the downstream IED should be opened and the normally open switch should be closed. The Operator typically directs the Substation Computer to do so, and the Substation Computer forwards the decision to the IEDs. When the IEDs perform the operations, power is restored to all portions of the feeders except the section in which the fault occurred. The more break points there are in the feeders, the fewer customers will be affected by a given fault.

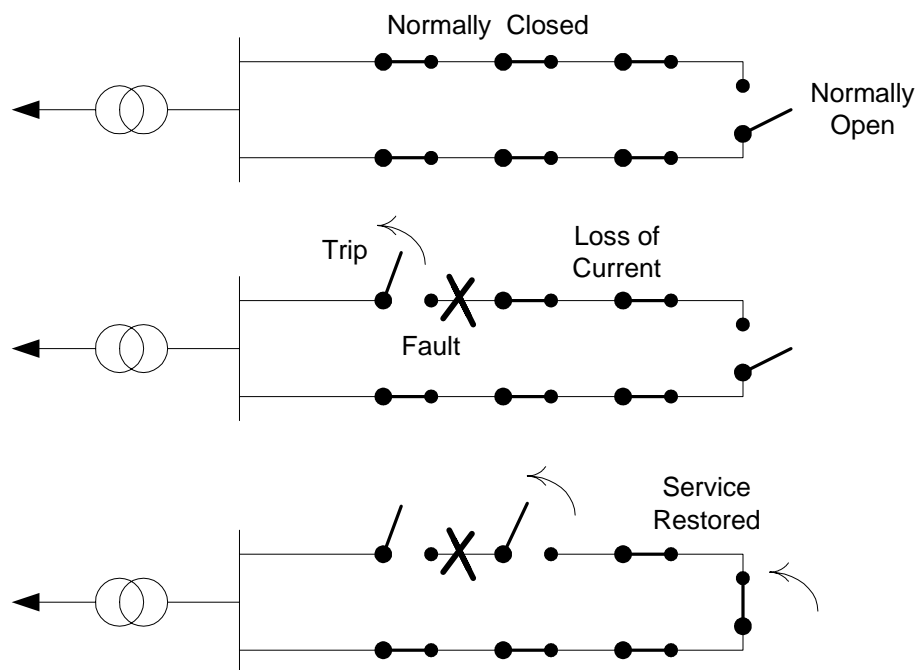

Time is of the essence in service restoration, but utilities typically require an Operator approve the decision of the system, so the human Operator is usually the slowest link in the system. Communications times may be measured in seconds. The breaker tripping is done by an individual IED without need for communications.

An alternative scenario occurs if the fault is not on the main feeder but on a lateral. In this case, the fault causes the protection IED at the substation to trip and attempt reclosure. While the current is zero between reclosure attempts, the IED nearest the fault opens its switch to clear the fault. This is called “auto-sectionalization”. Then, when the next reclosure occurs, service is restored to all subscribers except those on the lateral. In this case, there is no effect on the communications system other than to monitor that the events occurred.

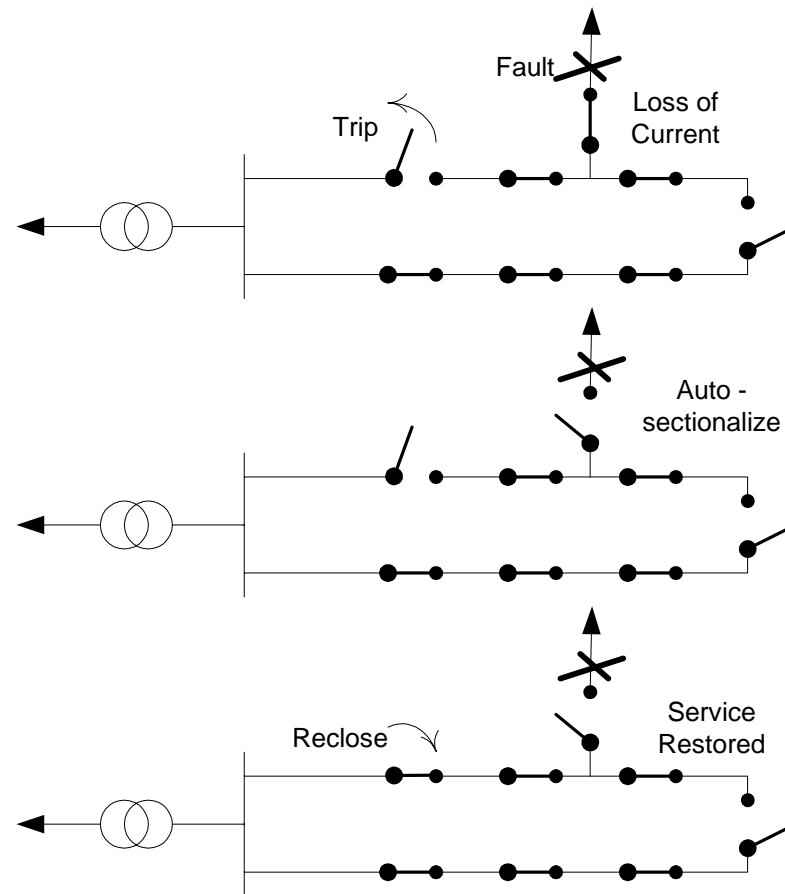

1.5 Actor (Stakeholder) Roles

Describe all the people (their job), systems, databases, organizations, and devices involved in or affected by the Function (e.g. operators, system administrators, technicians, end users, service personnel, executives, SCADA system, real-time database, RTO, RTU, IED, power system). Typically, these actors are logically grouped by organization or functional boundaries or just for collaboration purpose of this use case. We need to identify these groupings and their relevant roles and understand the constituency. The same actor could play different roles in different Functions, but only one role in one Function. If the same actor (e.g. the same person) does play multiple roles in one Function, list these different actor-roles as separate rows.

<i>Grouping (Community)'</i>		<i>Group Description</i>
<i>Actor Name</i>	<i>Actor Type (person, device, system etc.)</i>	<i>Actor Description</i>
SubstationComputerDevice	Device	Central location for automation logic in the substation. May have its own user interface, or communicate with the SystemOperator through a separate GUI.
IED	Device	Monitors and controls portions of the substation, feeders and transmission lines under direction of the SubstationComputerDevice
AutomationSystem	System	Optimizes the operation of the power system. Consists of the SystemOperator, SubstationComputerDevice, and IEDs.
SystemOperator	Person	Approves or rejects actions recommended by the SubstationComputerDevice.

Replicate this table for each logic group.

1.6 Information exchanged

Describe any information exchanged in this template.

<i>Information Object Name</i>	<i>Information Object Description</i>
Timestamp	A data event such as a change of state is associated with a timestamp that indicates when the change of state occurred relative to the system clock. There is often a 1 ms accuracy requirement that specifies that the timestamp must be within 1 millisecond of the actual event. The time stamp is applied at the device that is responsible for processing the field point for which the event occurred. The timestamp is then associated with the change of state event that is reported to the other devices in the system. These time stamped events can occur on the IED or the Data Concentrator if it is equipped with equipment to monitor field devices.
Point Number	The unique index of the point that is associated with the state or value that is currently of interest and is one of the points being monitored in the system. This number is a certain point in the IED, which becomes a different point in the Data Concentrator database and in turn becomes a different point number in the protocol that communicates with the GUI. There could be several mapping stages at each device the point goes through.
Voltage, Current	Analog values used in the system are often a twelve-bit or sixteen-bit integer that must be scaled for display in engineering units. The information includes: a point number, the quality of the point, and the value. It may or may not include a millisecond timestamp if the value is associated with a change event. A voltage would be scaled to engineering units of V or kV and a current in A. This is usually converted in the GUI which is a PC platform that supports floating point easily. This preserves the resolution in the raw data coming through the protocol. Point Number + Analog Value + Quality + Timestamp (optional)
Switch State	Digital Input with value Open or Closed, 0 or 1, Trip or Closed, Off or On, Normal or Alarm, etc. The change of state of a field input such as a switch. Includes: a point number, the quality of the point (online/offline or valid/invalid), the new state, and the time the state changed which is typically accurate to millisecond resolution. If the state of the input is Trip it represents a particular type of state change that indicates through its point number that a certain breaker has tripped and is now open. Includes all the same data as any state change but state is unique to the application. Point Number + Digital Value + Quality + Timestamp
Command	A control request is used to initiate a digital field operation such as close a breaker or switch. The operation required is defined in the protocol and can be a Trip or Close, Raise or Lower for a digital control or Open or Close or Raise or Lower for an analog event. The operator selects the operation type when the request is setup.
Duration or Count	The time in milliseconds that the coil of a relay will be energized in the device that is required to perform the requested command. The time is usually determined by how long it takes to pick up the field operation which seals itself in for the full duration of the operation. Most digital controls are short pulses between 500 and 1000 ms. Sometimes the operator enters the desired duration and sometimes it is pre configured in the device.
Control Request	Point Number + Command. A request initiated by the SystemOperator to the Station Computer, requesting that a

<i>Information Object Name</i>	<i>Information Object Description</i>
	particular control be operated. May be a single control or the start of a sequenced control.
Automated Control Request	Point Number + Command. A control request initiated by the SubstationComputerDevice to the SystemOperator in the form of a change of state on a data point or a GUI dialog box that pops up on the operator's screen. The animation will notify the operator that a request is pending and must be confirmed.
Confirm	The SystemOperator confirms (or rejects) an Automated Control Request from the SubstationComputerDevice. The SystemOperator typically clicks 'ok' on a dialogue box after performing any operational procedures that are required for ensuring the automated control can execute.
Control	Point Number + Command. The message sent from the SubstationComputerDevice to an IED to open or close a switch.
Tap Change Control	Point Number + Command + Duration or Count. The message sent from the SubstationComputerDevice to an IED to raise or lower a transformer tap.
Control Status	The SubstationComputerDevice indicates the success or failure of a Control Request to the SystemOperator as a console GUI message, dialog box, and/or an alarm indication.

1.7 Activities/Services

Describe or list the activities and services involved in this Function (in the context of this Function). An activity or service can be provided by a computer system, a set of applications, or manual procedures. These activities/services should be described at an appropriate level, with the understanding that sub-activities and services should be described if they are important for operational issues, automation needs, and implementation reasons. Other sub-activities/services could be left for later analysis.

<i>Activity/Service Name</i>	<i>Activities/Services Provided</i>
Optimize Substation Voltage	Raise or lower substation transformer taps
Reduce Reactive Load	Switch capacitor banks and shunts in or out of the power system
Prevent Unsafe Operations	Reject controls that would cause faults or other unsafe procedures
Perform Sequenced Controls	Perform several controls in an atomic sequence to reduce or eliminate outages
Balance Load	Connect two feeders or transmission lines together to reduce the load on equipment
Restore Service	Isolate faulted segments of feeders or transmission lines and redirect power from nearby sources to restore service

<i>Activity/Service Name</i>	<i>Activities/Services Provided</i>
Select/Execute Logic	Operation of a digital output by “I tell you twice” logic to prevent misoperation.

1.8 Contracts/Regulations

Identify any overall (human-initiated) contracts, regulations, policies, financial considerations, engineering constraints, pollution constraints, and other environmental quality issues that affect the design and requirements of the Function.

<i>Contract/Regulation</i>	<i>Impact of Contract/Regulation on Function</i>

<i>Policy</i>	<i>From Actor</i>	<i>May</i>	<i>Shall Not</i>	<i>Shall</i>	<i>Description (verb)</i>	<i>To Actor</i>
Unsafe Operation	AutomationSystem		X		Permit manually-initiated faults	SystemOperator
Reactive Load	AutomationSystem			X	Maintain Power Factor or VARs within preset limits	SystemOperator
Maximum Load	AutomationSystem			X	Maintain current on a particular feeder or transmission line below preset limits	SystemOperator
Substation Voltage	AutomationSystem			X	Maintain voltage within the substation within preset limits	SystemOperator
Break Before Make Outage	AutomationSystem			X	Minimize the length of outage required by “break before make” operations	SystemOperator
Service Affected	AutomationSystem			X	Minimize the number of subscribers affected by a fault	SystemOperator

<i>Constraint</i>	<i>Type</i>	<i>Description</i>	<i>Applies to</i>

2 Step by Step Analysis of Function

Describe steps that implement the function. If there is more than one set of steps that are relevant, make a copy of the following section grouping (Preconditions and Assumptions, Steps normal sequence, and Steps alternate or exceptional sequence, Post conditions)

2.1 Steps to implement function

Name of this sequence.

2.1.1 Preconditions and Assumptions

Describe conditions that must exist prior to the initiation of the Function, such as prior state of the actors and activities

Identify any assumptions, such as what systems already exist, what contractual relations exist, and what configurations of systems are probably in place

Identify any initial states of information exchanged in the steps in the next section. For example, if a purchase order is exchanged in an activity, its precondition to the activity might be 'filled in but unapproved'.

<i>Actor/System/Information/Contract</i>	<i>Preconditions or Assumptions</i>

2.1.2 Steps – Normal Sequence

Describe the normal sequence of events, focusing on steps that identify new types of information or new information exchanges or new interface issues to address. Should the sequence require detailed steps that are also used by other functions, consider creating a new “sub” function, then referring to that “subroutine” in this function. Remember that the focus should be less on the algorithms of the applications and more on the interactions and information flows between “entities”, e.g. people, systems, applications, data bases, etc. There should be a direct link between the narrative and these steps.

The numbering of the sequence steps conveys the order and concurrency and iteration of the steps occur. Using a Dewey Decimal scheme, each level of nested procedure call is separated by a dot ‘.’. Within a level, the sequence number comprises an optional letter and an integer number. The letter specifies a concurrent sequence within the next higher level; all letter sequences are concurrent with other letter sequences. The number specifies the sequencing of messages in a given letter sequence. The absence of a letter is treated as a default ‘main sequence’ in parallel with the lettered sequences.

Sequence 1:

*1.1 - Do step 1
1.2A.1 - In parallel to activity 2 B do step 1
1.2A.2 - In parallel to activity 2 B do step 2
1.2B.1 - In parallel to activity 2 A do step 1
1.2B.2 - In parallel to activity 2 A do step 2
1.3 - Do step 3
1.3.1 - nested step 3.1
1.3.2 - nested step 3.2*

Sequence 2:

*2.1 - Do step 1
2.2 - Do step 2*

#	Event	Primary Actor	Name of Process/Activity	Description of Process/Activity	Information Producer	Information Receiver	Name of Info Exchanged	Additional Notes	IECSA Environments
#	<i>Triggering event? Identify the name of the event.¹</i>	<i>What other actors are primarily responsible for the Process/Activity? Actors are defined in section 1.5.</i>	<i>Label that would appear in a process diagram. Use action verbs when naming activity.</i>	<i>Describe the actions that take place in active and present tense. The step should be a descriptive noun/verb phrase that portrays an outline summary of the step. "If ...Then...Else" scenarios can be captured as multiple Actions or as separate steps.</i>	<i>What other actors are primarily responsible for Producing the information? Actors are defined in section 1.5.</i>	<i>What other actors are primarily responsible for Receiving the information? Actors are defined in section 1.5. (Note – May leave blank if same as Primary Actor)</i>	<i>Name of the information object. Information objects are defined in section 1.6</i>	<i>Elaborate architectural issues using attached spreadsheet. Use this column to elaborate details that aren't captured in the spreadsheet.</i>	<i>Reference the applicable IECSA Environment containing this data exchange. Only one environment per step.</i>

¹ Note – A triggering event is not necessary if the completion of the prior step – leads to the transition of the following step.

#	Event	Primary Actor	Name of Process/Activity	Description of Process/Activity	Information Producer	Information Receiver	Name of Info Exchanged	Additional Notes	IECSA Environments
1.1	Voltage Change	IEDs	Change in Voltage	<p>VOLTAGE REGULATION. IED identifies that the voltage has exceeded the deadband to be recognized as a change and notifies the SubstationComputerDevice.</p> <p>May be performed by one or more IEDs depending on the logic being used. SubstationComputerDevice maps the point number into its database, stores the value, and runs the voltage control logic. Typically starts a qualification timer to avoid rapid and frequent tap changes.</p>	IEDs	SubstationComputerDevice	Voltage	Scaling typically configured at SC.	High security Intra-Sub

#	Event	Primary Actor	Name of Process/Activity	Description of Process/Activity	Information Producer	Information Receiver	Name of Info Exchanged	Additional Notes	IECSA Environments
1.2	Qualification Timeout	SubstationComputerDevice	Tap Change	<p>SubstationComputerDevice identifies that the voltage change(s) received from the IED(s) represent a significant change and require action. Issues a command to the IED.</p> <p>IED performs the tap change through local I/O. Causes voltage change (1.1) and cycle repeats.</p>	SubstationComputerDevice	IED	Tap Change Control	<p>Raise is often issued to a different point than the Lower.</p> <p>Some tap changers require multiple pulses, other varying durations.</p>	High security Intra-Sub

#	Event	Primary Actor	Name of Process/Activity	Description of Process/Activity	Information Producer	Information Receiver	Name of Info Exchanged	Additional Notes	IECSA Environments
2.1	Load Change	IED	Change in Load	<p>VOLT/VAR REGULATION. IED identifies that the voltage and/or current has exceeded the deadband to be recognized as a change and notifies the SubstationComputerDevice.</p> <p>May be performed by one or more IEDs depending on the logic being used. SubstationComputerDevice maps the point number into its database, stores the value, and runs the Volt/VAR control logic. Starts a qualification timer if appropriate.</p> <p>If extremely simple control logic is being used (e.g. calendar, time-of-day, this step may be omitted).</p>	IED	SubstationComputerDevice	Voltage, Current	Scaling typically configured at SC.	High security Intra-sub

#	Event	Primary Actor	Name of Process/Activity	Description of Process/Activity	Information Producer	Information Receiver	Name of Info Exchanged	Additional Notes	IECSA Environments
2.2	Qualification Timeout	SubstationComputerDevice	Adjust Reactive Load	<p>SubstationComputerDevice decides that it is time to adjust the load and issues a control to the appropriate IED. Applies qualification times and hysteresis algorithms to avoid many rapid adjustments.</p> <p>May not be the same IED as last reported a Load Change.</p> <p>Adjustment usually causes a Load Change (2.1) and cycle repeats.</p>	SubstationComputerDevice	IED	Control		High security Intra-sub
3.1	System State Change	IED	Change of System State	<p>INTERLOCKING. IED detects a change in a switch or breaker that it is monitoring and transmits the state change to the device implementing the logic, either the SubstationComputerDevice or one or more peer IEDs.</p> <p>SubstationComputerDevice or peer IED maps the point number into its database, stores the value, and thus updates its current “picture” of the system state.</p>	IED	IED or SubstationComputerDevice	Switch State, Voltage, Current	Logic may be centralized at SubstationComputerDevice or distributed among IEDs (peer-to-peer)	High security Intra-Sub

#	Event	Primary Actor	Name of Process/Activity	Description of Process/Activity	Information Producer	Information Receiver	Name of Info Exchanged	Additional Notes	IECSA Environments
3.2	Switch Request	SystemOperator	Request Switch	SystemOperator requests that a particular switch or breaker be opened or closed. Device receiving the command runs interlocking logic and either denies (3.3) or accepts (3.4) the request.	SystemOperator	IED or SubstationComputerDevice	Control Request	May be issued at master station, SubstationComputerDevice, or IED.	Intra-control center
3.3		IED or SubstationComputerDevice	Deny Request	Device performing the interlocking logic rejects the attempt as being unsafe.	IED or SubstationComputerDevice	SystemOperator	Control Status	May take place during either Select or Execute phase of the request.	Intra-control center
4.1	Sequenced Control Request	SystemOperator	Request Sequenced Control	SEQUENCED CONTROL. SystemOperator requests a sequence to be performed.	SystemOperator	SubstationComputerDevice	Control Request		Intra-control center
4.2		SubstationComputerDevice	Send Control	SubstationComputerDevice runs the sequence logic and issues the next control to an IED.	SubstationComputerDevice	IED	Control	Timing between successive controls may be constrained in order to prevent outages.	High security Intra-Sub

#	Event	Primary Actor	Name of Process/Activity	Description of Process/Activity	Information Producer	Information Receiver	Name of Info Exchanged	Additional Notes	IECSA Environments
4.3	Feedback	IED	Send Feedback	<p>IED provides feedback about whether the last control was successful.</p> <p>SubstationComputerDevice maps the point number into its database, stores the value, and runs the sequence logic. Typically logs the state change and its time.</p> <p>If feedback was successful, SubstationComputerDevice initiates next control (4.2). If not, if the feedback timed out, or if this was the last control, may terminate sequence (4.4).</p>	IED	SubstationComputerDevice	Switch State	Feedback must come from actual I/O in order for logic to rely on it.	High security Intra-Sub
4.4	Sequence Complete	SubstationComputerDevice	Terminate Sequence	SubstationComputerDevice stops the sequence logic and indicates to SystemOperator the status of the sequence.	SubstationComputerDevice	SystemOperator	Control Status		Intra-control center

#	Event	Primary Actor	Name of Process/Activity	Description of Process/Activity	Information Producer	Information Receiver	Name of Info Exchanged	Additional Notes	IECSA Environments
5.1	Load Change	IED(s)	Change in Load	<p>LOAD BALANCING. IED identifies that the current has exceeded the deadband to be recognized as a change and notifies the SubstationComputerDevice.</p> <p>May be performed by one or more IEDs depending on the logic being used. SubstationComputerDevice maps the point number into its database, stores the value, and runs the load balancing control logic.</p>	IED(s)	SubstationComputerDevice	Current, Voltage	Scaling typically configured at SC.	High security Intra-Sub
5.2	Request to Connect Feeders / Lines	SubstationComputerDevice	Request Connection to Feeders / Lines	<p>SubstationComputerDevice determines that load has exceeded acceptable thresholds and that conditions are met to perform balancing.</p> <p>Requests that SystemOperator connect a particular two feeders or lines.</p> <p>SystemOperator either confirms the operation (5.3) or does nothing, and load continues to increase (5.1).</p>	SubstationComputerDevice	SystemOperator	Automated Control Request		Intra-control center

#	Event	Primary Actor	Name of Process/Activity	Description of Process/Activity	Information Producer	Information Receiver	Name of Info Exchanged	Additional Notes	IECSA Environments
5.3		SystemOperator	Confirm Request	SystemOperator issues control accepting the request.	SystemOperator	SubstationComputerDevice	Confirm		Intra-control center
5.4		SubstationComputerDevice	Balance Load	SubstationComputerDevice issues a control to connect the two feeders or lines. Load will readjust and cycle repeats (5.1).	SubstationComputerDevice	IED	Control		High security Intra-Sub
6.1	Fault	Upstream IED	Breaker Trip	AUTOMATIC SERVICE RESTORATION. IED detects fault and trips breaker. Notifies SubstationComputerDevice of the trip, and (through the point number) the direction and distance to the fault.	Upstream IED	SubstationComputerDevice	Trip	IED is typically on pole-top and may be reached by slow links.	High security Intra-Sub
6.2	Loss of Current	Downstream IEDs	Report Loss of Current	IEDs detect loss of current. Notify SubstationComputerDevice of the event and the suspected direction and distance of the fault.	Downstream IEDs	SubstationComputerDevice	No Current Detected, No Voltage Detected	IEDs running on battery power	High security Intra-Sub

#	Event	Primary Actor	Name of Process/Activity	Description of Process/Activity	Information Producer	Information Receiver	Name of Info Exchanged	Additional Notes	IECSA Environments
6.3		SubstationComputerDevice	Request Restoration	SubstationComputerDevice runs auto-restoration logic and determines which switch should open. Requests permission to open that switch and close the normally-open switch. SystemOperator will either confirm the request (6.4), or decide to perform some other operation through the SubstationComputerDevice.	SubstationComputerDevice	SystemOperator	Automated Control Request		Intra-control center
6.4		SystemOperator	Confirm Request	SystemOperator tells the SubstationComputerDevice to execute the restoration.	SystemOperator	SubstationComputerDevice	Confirm		Intra-control center
6.5		SubstationComputerDevice	Open Switch	Substation computer performs control to open the downstream switch nearest the fault.	SubstationComputerDevice	Downstream IED	Control		High security Intra-Sub
6.6		SubstationComputerDevice	Close Switch	SubstationComputerDevice performs control to close the normally-open switch.	SubstationComputerDevice	IED controlling normally open switch	Control		High security Intra-Sub

#	Event	Primary Actor	Name of Process/Activity	Description of Process/Activity	Information Producer	Information Receiver	Name of Info Exchanged	Additional Notes	IECSA Environments
6.7		IEDs	Send Feedback	IEDs update system state and load to SubstationComputerDevice. SubstationComputerDevice maps data and stores in database.	IEDs	SubstationComputerDevice	Switch State, Current, Voltage		High security Intra-Sub

2.1.3 Steps – Alternative / Exception Sequences

Describe any alternative or exception sequences that may be required that deviate from the normal course of activities. Note instructions are found in previous table.

#	Event	Primary Actor	Name of Process/Activity	Description of Process/Activity	Information Producer	Information Receiver	Name of Info Exchanged	Additional Notes	IECSA Environments
3.4		IED or SubstationComputerDevice	Execute Request	Device performing the interlocking logic tells the IED to operate the control request. May be the same IED.	IED or SubstationComputerDevice	IED	Control		High security Intra-Sub
3.5		IED or SubstationComputerDevice	Confirm Request	Device performing the interlocking logic informs the SystemOperator that the request has been successfully performed.	IED or SubstationComputerDevice	SystemOperator	Control Status	May take place during either Select or Execute phase of the request.	Intra-Control Center

#	Event	Primary Actor	Name of Process/Activity	Description of Process/Activity	Information Producer	Information Receiver	Name of Info Exchanged	Additional Notes	IECSA Environments
X.1	Fault	Upstream IED	Trip Breaker	IED detects fault and trips breaker. Notifies SubstationComputerDevice of the trip, and (through the point number) the direction and distance to the fault. Starts reclosure timer.	Upstream IED	SubstationComputerDevice	Trip		High security Intra-Sub
X.2		Lateral IED	Report Lateral Switch Open	IED detects the fault and that current is zero. Waits a configured number of reclosure attempts, then opens the switch for the Lateral. Notifies the SubstationComputerDevice.	Lateral IED	SubstationComputerDevice	Switch State		High security Intra-Sub
X.3		Upstream IED	Breaker Reclosed	Upstream IED successfully recloses the breaker and notifies the SubstationComputerDevice that service is restored.	Upstream IED	SubstationComputerDevice	Switch State		High security Intra-Sub

2.1.4 Post-conditions and Significant Results

Describe conditions that must exist at the conclusion of the Function. Identify significant items similar to that in the preconditions section.

Describe any significant results from the Function

<i>Actor/Activity</i>	<i>Post-conditions Description and Results</i>

2.2 Architectural Issues in Interactions

Elaborate on all architectural issues in each of the steps outlined in each of the sequences above. Reference the Step by number..



Microsoft Excel
Worksheet

2.3 Diagram

For clarification, draw (by hand, by Power Point, by UML diagram) the interactions, identifying the Steps where possible.

3 Auxiliary Issues

3.1 References and contacts

Documents and individuals or organizations used as background to the function described; other functions referenced by this function, or acting as “sub” functions; or other documentation that clarifies the requirements or activities described. All prior work (intellectual property of the company or individual) or proprietary (non-publicly available) work must be so noted.

ID	Title or contact	Reference or contact information
[1]		
[2]		

3.2 Action Item List

As the function is developed, identify issues that still need clarification, resolution, or other notice taken of them. This can act as an Action Item list.

ID	Description	Status
[1]		
[2]		

3.3 Revision History

For reference and tracking purposes, indicate who worked on describing this function, and what aspect they undertook.

No	Date	Author	Description
0.	Oct 17, 2003	GG	Initial version.

Contingency Analysis - Baseline

1 Descriptions of Function

All prior work (intellectual property of the company or individual) or proprietary (non-publicly available) work should be so noted.

1.1 Function Name

Contingency Analysis – Baseline (current usage)

1.2 Function ID

IECSA identification number of the function TBD

1.3 Brief Description

Describe briefly the scope, objectives, and rationale of the Function.

In layman's terms, Contingency Analysis (CA) is a "what if" scenario simulator that evaluates, provides and prioritizes the impacts on an electric power system when problems occur. A contingency is the loss or failure of a small part of the power system (e.g. a transmission line), or the loss/failure of individual equipment such as a generator or transformer. This is also called an unplanned "outage". Contingency analysis is a computer application that uses a simulated model of the power system, to:

- evaluate the effects, and
- calculate any overloads,

resulting from each outage event.

Contingency Analysis is essentially a "preview" analysis tool. It simulates and quantifies the results of problems that could occur in the power system in the immediate future.

CA is used as a study tool for the off-line analysis of contingency events, and as an on-line tool to show operators what would be the effects of future outages. This allows operators to be better prepared to react to outages by using pre-planned recovery scenarios.

1.4 Narrative

A complete narrative of the Function from a Domain Expert's point of view, describing what occurs when, why, how, and under what conditions. This will be a separate document, but will act as the basis for identifying the Steps in Section 2.

1.4.1 Notes and definitions

This narrative is intended to provide an overview of the ContingencyAnalysisSystem, including its major components, methodology, use, users, and a summary of its data inputs and outputs. This narrative is not intended to be a course in power engineering, and so will deal with everything at a high level.

1. The term "security" refers to the secure and stable operation of the electric power system in case of one or more equipment failures. It does not refer to the protection of digital information from computer "hackers" in the data communications world.
2. An "element" of a power system usually refers to its electrical equipment (e.g. generator, transformer, transmission line, circuit breaker, etc.). An "outage" is the removal of equipment from service. It can be intentional and planned (i.e. for maintenance), or unplanned (i.e. due to failure). Element can also refer to the wider context of a group of devices that together constitute an outage, such as a busbar which effectively goes out of service if one or more breakers do not operate correctly.
3. This narrative provides a high level and generic view of the Contingency Analysis software application. Each utility's use of this application will vary, ranging from off-line use in study and planning mode only, to its on-line use by system operators and network engineers for decision support.
4. The fine points and variations of what exactly constitutes a "contingency" or failure of some part of the power system are not covered in this narrative.
5. Related applications for security analysis of the power system, and supporting applications in SCADA and Energy Management Systems, are simply referenced, not described.
6. A high level and generic explanation is provided of the power flow algorithm, which is the basis of the contingency analysis. More detailed coverage is not necessary to understand the functionality of CA.

1.4.2 Overview of Contingency Analysis

Evaluation of power system security is necessary in order to develop ways to maintain system operation when one or more elements fail. A power system is "secure" when it can withstand the loss of one or more elements and still continue operation without major problems.

Contingency Analysis (CA) is one of the "security analysis" applications in a power utility control center that differentiates an Energy Management System (EMS) from a less complex SCADA system. Its purpose is to analyze the power system in order to identify the overloads and problems that can occur due to a "contingency". A contingency is the failure or loss of an element (e.g. generator, transformer, transmission line, etc.), or a change of state of a device (e.g. the unplanned opening of a circuit breaker in a transformer substation) in the power system. Therefore contingency analysis is an application that uses a computer simulation to evaluate the effects of removing individual elements from a power system.

After a contingency event, power system problems can range from:

- none - when the power system can be re-balanced after a contingency, without overloads to any element, to
- severe - when several elements such as lines and transformers become overloaded and risk damage, to
- critical - when the power system becomes unstable and will quickly collapse.

Current electric utility operating policies (such as NERC's) require that each utility's power system must be able to withstand and recover from any "first contingency" or any single failure. Future policies may extend this to withstanding a "second contingency" or any subsequent single failure. Therefore contingency analysis is one of the tools used primarily by power system planners and engineers to "test" the power system (using a software model) for its strengths and weaknesses, and for compliance with the operating policies. CA has always been an important part of electric utility system planning and operations, even before there were computers to assist the analysis, when manual calculations were used.

By analyzing the effects of contingency events in advance, problems and unstable situations can be identified, critical configurations can be recognized, operating constraints and limits can be applied, and corrective actions can be planned.

In the planning mode, apart from analysis of the complete power system for overall security, CA is also used for scheduling the withdrawal of power system equipment for periodic or restorative maintenance. The effects of equipment outages are evaluated using future operating conditions of the power system. The schedule for planned outages is arranged for minimal risk of problems by using these CA studies, to avoid scheduling concurrent outages of critical system elements.

CA is therefore a primary tool used for preparation of the annual maintenance plan and the corresponding outage schedule for the power system. This outage schedule requires modification to reflect changes in the operating conditions over time, and so CA is used repeatedly to refine the schedule of planned outages, for long term and short term planning. If there are no problems revealed by a final check using CA just before an outage is scheduled to take place, the planned outage is approved by the outage coordinator or network engineer, and it is implemented by the system operator or dispatcher in the control center. Operators perform the outage by using the DAC (data acquisition and control) applications to open breakers and switches, to isolate equipment from the power system.

1.4.2 Methodology and the contingency analysis process

The CA application is based on a detailed electrical model of the power system, called the "network model". This is a simulated model of the real power system that is prepared by each utility's system planners and network engineer specialists. They translate the real world equipment and connections of a power system (typically shown in a schematic representation, called a one-line diagram) into a mathematical model of the power network that is suitable for solution by computer algorithms. This network model contains the connection information (called the topology and connectivity), and the electrical characteristics of the equipment (such as the impedance of transmission lines). The algorithm in contingency analysis uses this network information (often called network "parameters") and the network model to simulate, and calculate the effects of, removing equipment from the power system.

The network model is usually the same model used in other security analysis applications, so it must be accurate and must reflect the real world power system in order to provide realistic and useful results. For many utilities, in order to be accurate the size of the network model will be several hundred or even a few thousand "buses" (connection points for electrical components of the model) and "branches" (connected components of the model, between the buses). The network model may be reduced or simplified from its real world configuration, containing fewer buses and fewer electrical components than are shown on the detailed one-line diagram of the system. However network engineers prepare the model with enough detail to provide a good simulation of the operation of the real power system, with accurate results.

The network model is simply a static set of parameters and equations, but it cannot be "solved" (i.e. used to calculate results) until it is "initialized" by entering "starting" values for the simulated power system. These starting values are the real world starting point for the algorithm, so that it works with real data that reflects the current operating conditions in the power system. Initialized values are the real world reference for the network model.

Initialized values include bus voltages, production levels for each generator, loads, and power interchanges with neighboring utilities. Initial values are sometimes taken from the current SCADA database (measurements from field transducers) at the control center. Preferably the initial values are taken from the State Estimator database (if this application exists and is reliable), because these values are estimated and are more accurate representations of the actual state of the power system. Other parameters such as operating and

equipment limits, and generation participation factors are also taken from the SCADA database to be used as references for calculating overloads and violations.

The multiple sets of limits that may be used for power system operations and for security analysis is a complex subject that is beyond the scope of this narrative about CA.

With an initialized power network model, contingency analysis can now be executed with a series of contingency events that is prepared by the CA user. A "contingency list" contains each of the elements that will be removed from the network model, one by one, to test the effects for possible overloads of the remaining elements. The criteria for selection of elements for the contingency events are further described below.

In its basic form, CA executes a "power flow" analysis for each potential problem that is defined on a contingency list. The power flow (sometimes called a load flow) is the name of the algorithm used by contingency analysis to solve for the currents, voltages, and real and reactive power flows (MW and MVA) in each part of the power system. A "network solution" consists of these calculated results for every bus and branch in the power network model.

The failure or outage of each element in the contingency list (e.g. a loss of a generator or a transmission line) is simulated in the network model by removing that element. The resulting network model is solved (i.e. computer programs solve the complex matrix equations that make up the power flow algorithm) to calculate the resulting power flows, voltages, and currents for the remaining elements of the model.

Results of each contingency test – the network solution – are compared with the limits for every element in the power system. For example, a transmission line that was loaded at 85% of its MVA rating before the contingency event, might now be loaded at 120% of its rating after the event. Similarly a load bus voltage may fall to 90% of its nominal value, due to the same contingency. If limit violations occur, these are arranged in a tabular list according to how serious the overloads or violations are. The list of violations is saved in the CA database. The CA process continues - the network model is reset to its initial operating conditions, and the next contingency (element outage) is applied and analyzed. This process continues one after another, until all the contingency events on the test list are examined. All the violations resulting from each contingency, one list per contingency, are saved in the CA database for review by users.

Typically the power system model is tested for many hundreds of possible problems, including the failure of each generator and line, as well as other elements. These events are placed on the contingency list by experienced planning and operations engineers because of their importance - the severity of their effects, and their likelihood (probability) of occurrence. Establishing the contingency lists is a result of planning studies that use power flows to identify the sensitive areas of a power network, under various loading conditions. In practice these sensitivity studies can reduce the number of contingencies that need to be evaluated by CA, to study only the most serious and likely events.

Large computer resources are needed to process a power flow solution for each contingency in a large power system composed of many hundreds of elements, especially when these studies are conducted for several operating states and loading levels of the system. If voltage violations and reactive power flows are of most concern in a particular system or operating state, then a complete AC power flow is required for each contingency.

Execution times for testing hundreds of contingencies have of course been reduced significantly over the past 30 years, and it is now possible to execute the CA in a few seconds with current control center computers. Other methods are used in practice to further improve CA execution times, such as the use of simpler DC power flow analysis when approximate MW power flows are more important than voltage limits on buses. Therefore CA can be used not only as a system planning tool, but is "fast enough" to be used as an on-line analysis tool by power system dispatchers and network engineers, to support preventive and corrective operator actions in case of problems.

1.4.3 Results and use

The results of the CA are compared against safe operating and stability limits for each element of the power system being studied. Violations for each overloaded element are shown in lists (e.g. "For contingency #1 outage of generating unit G001, line L123 exceeds normal MVA limit by 50%"). The results of the contingency analysis are organized by ranking of their severity –the most overloaded elements of the power system appear at the top of the list. Lists can contain hundreds of entries, but typically the most important violations are in the top 50, and these indicate the major problem areas.

In practice there can be more than one operating limit for many elements of the power system, such as short-term and long-term thermal limits (e.g. ambient temperature and the duration of an overload affect the safe operating limits for transformers and transmission lines). There can also be several stability limits for lines and interconnections, depending on the configuration and the operating state of the power system (light, medium, or heavy loading). All of these limits are checked by CA, upon selection by the user.

In the real power network, if limits are exceeded after the first contingency event happens, protection equipment will react and remove overloaded equipment from the power system. This can create further overloads, resulting in cascading outages, which could eventually collapse the power system in a complete blackout.

Therefore the results of CA are used initially by system planners, to study the effects of outages and to establish secure operating limits and constraints for the power system under different conditions. NetworkEngineers use CA as a study tool to develop corrective actions in predefined "cookbooks" for system operators, to improve their ability to resolve problems. In addition CA is used as an on-line decision support tool to assist the operators' understanding and correction of unusual situations, by looking at the effects of possible outage events.

1.4.4 Current CA implementation

In current Energy Management Systems and planning departments, CA is no longer a separate application, and is often an extension of the power flow or optimal power flow applications. This allows the related applications to work from common network models and base cases, and provides a single point of editing and maintenance.

Since the results of contingency analysis are used to define operating limits and constraints for the power system, combined applications have evolved such as Security Constrained Economic Dispatch, Security Constrained Unit Commitment, and Security Constrained Optimal Power Flow. These advanced applications use the CA results to directly provide operating limits and constraints as part of their results, to streamline the process instead of using separate applications to come up with the same results.

1.4.5 CA evolution, users and future

Contingency analysis was originally (in the 1960s) such a computer intensive application that its use was limited to power system planners, for evaluating the design of the power system and to develop operating constraints and corrective measures for the dispatchers. Analysis was performed in off-line computers, often in large mainframes or specialized engineering minicomputers. Results were typically available only after many hours of computation, with huge stacks of paper printouts (remember those?) needing days of line-by-line analysis by power system experts.

Due to vastly increased computer power and the use of special selection techniques to minimize the contingency events that need to be examined, in 2004 the CA application has become very fast. Results are available in seconds and graphical display tools allow quick visual analysis. CA can therefore be used as an on-line operations support tool, by dispatchers and network engineers.

However CA is still a complex application, and like many of the security analysis applications, its acceptance for on-line use by system dispatchers has been limited. Procedures that are acceptable for backroom analysts are not adequate for busy operations staff. The workload of executing regular power dispatch and switching tasks, reacting to problem situations, and entering data for reports, does not leave much time for the dispatcher's use of advanced security analysis applications. Relatively complex initialization, data entry requirements, and infrequent use also mean a re-learning curve that further affects its acceptance. Future improvements in the human interface and set up procedures may increase the use of CA as an on-line tool.

CA is used in a wider arena, for analyzing huge power pool and wide area networks for operating regions such as the Midwest ISO (Independent System Operator). Power marketing and trading entities, as well as the ISOs and TSOs (Transmission System Operator), have driven some of these requirements. For these very large network models, further improvements in execution time, user tools and results presentation will be needed in order for the application to be effective.

1.4.6 Data Inputs and Outputs

The CA application requires data inputs from many sources, including:

- equipment lists for the power systems to be studied
- contingency lists of the selected elements to be studied
- sets of limits for power system elements (lines, generators, transformers, etc.)
- base case "starting" data to initialize the network model (often this is the current network solution taken from the state estimator application)
- other base cases for studies of other power system operating states (saved cases from the study power flow application)
- power system loading models (these may be part of the base cases)
- "triggers" to start the application, such as automatic execution upon loss of a power system element, periodic execution as part of the security analysis sequence, or manual execution "on demand" by a user

In addition, CA users enter or select data such as:

- definition and selection of contingencies (list of outages to be analyzed, activate or deactivate violation checking, etc.)
- selection of base cases (initial conditions for the power network model)
- execution control parameters (groups of contingencies, participation of units in generation loss, number of highest priority contingencies to be processed)
- enable automatic grouping of switching devices to define an element outage
- enable generation of warnings and alarms (usually for on-line users)
- severity ranking of contingencies (various factors can be used and weighted to rank and display the limit violations, such as branch current or MVA flow, bus voltage, reactive power generation, bus voltage shifts, reactive power shifts, etc.)
- adjustments to the weighting factors
- stop the CA execution at certain points in its sequence

The CA application provides several outputs, such as:

- displays for users to set up and control the application

- execution status and problem displays, showing progress and non-convergence situations
- results – in the form of many types of contingency violation lists, according to severity, type of equipment, loss of generation or load, equipment affected by multiple contingencies, creation of islands, etc.
- results – in the form of many types of graphical displays, showing the overloads on one-line diagrams with color codes for severity, flags for types of problems, graphs, and even 3D representations of groups of analyses, etc.
- visible warnings and audible alarms for operations staff and dispatchers, and sometimes for study users, to alert them about potential problems if certain contingencies should occur in the future

1.4.7 Shortcomings in Current Contingency Analysis

As mentioned previously in section 1.4.5, the CA application has some shortcomings in current practice. Some of these result in CA being more useful as an off-line planning tool than as an on-line tool for operators. Other shortcomings restrict its capability in identifying problems outside the immediate control area that could impact the control area, or limit the effective conversion of its voluminous numerical results into meaningful information and intelligence for operations use.

Some of the CA shortcomings could be addressed with an improved communications architecture, which would support the use of more, more frequent, higher quality, and wider-area data. This would enhance CA to form one of the tools necessary for the future "self healing grid" that the IECSA project is helping to define. In the list below, the CA shortcomings that are candidates for improvement with an advanced communications architecture are marked with an asterisk (*).

The list of CA shortcomings includes:

(a) Lack of Reliability and Robustness in the CA solution "engine"

- "touchy"
- "sensitive"
- breaks easily
- sometimes needs assistance by a programmer-analyst and a network engineer to resolve problems

(b) Usability – difficult to set up and use CA

- Complex application
- Sometimes needs programmer-level entries in "code"
- Sometimes minimal use of dialogue boxes and menus for users
- Access to various data sources is not consistent
- Access to alternate and wider area data (to resolve situations of faulty, incomplete or missing data, needed for dependable solutions) is rarely provided (*)
- Definition and selection of contingencies can be lengthy

- Poor user guides
- Poor or no scripts to follow
- Lack of default entries, "prompts" and "help" features

Summary - CA can be flexible and capable, but is rarely an "elegant" application; it needs an intuitive interface and better user features.

(c) Difficult for users to interpret the avalanche of numeric CA results

- Summaries of overloads and violations are usually tabular displays, without being integrated in one-line diagrams for easier association with the power network
- Few or no graphic tools to assist interpretation of hundreds of numbers
- Comprehension of CA results can be relatively slow for new users

Summary - not an intuitive output style.

(d) Restricted visibility - not always a "wide area" or regional solution (*)

- May not show the problems at boundaries of the power system (*)
- Without a large area model, CA can not show problems that start in remote locations, beyond the local control area (*)
- Does not always "see" accurate topology, even in the local control area

(e) Few or no remedial action suggestions for operators

- rarely provides operator "action lists", especially for unusual situations
- does not suggest remedial actions for wide area implementation, using coordinated multi-utility operations (*)

(f) Slow performance

- Can sometimes be too slow for operators to use effectively for decision support, although modern computers can handle most requirements

(g) No intelligence or learning from previous cases

CA can be initiated from previous base cases, but the application is not equipped with intelligence to learn from previous cases:

- How to assist the set up procedure, using self-start procedures
- How to resolve difficult situations (for example by trying or suggesting fixes to problems, such as interrogating and using alternate data sources) (*)

(h) Relatively isolated application, no links with Equipment Condition Monitoring (for revised limits and integration with outage scheduling for maintenance) or Phase Angle telemetry (operating conditions could trigger the CA analysis) (*)

- CA shows its "study function" roots, since it is not usually linked with real-time triggers or telemetry
- Closer coupling with equipment condition and state measurement telemetry would enhance the value of CA (*)

(i) Rarely coupled with the Training Simulator

- CA study cases should be easily transferable to the Training Simulator for use in building scenarios

These and other CA shortcomings combine to make it less effective than its potential as a refined and usable decision support and guidance tool for operations.

The interim report on the August 14, 2003 blackout ("U.S. – Canada Power System Outage Task Force, Interim Report: Causes of the August 14th Blackout ... November 2003") refers to some of these CA shortcomings, such as restricted visibility of the regional power system, and the need for correct topology data.

The "future" Contingency Analysis will be defined (in another template) to improve many of these current shortcomings, and to make CA a key component of the "self healing grid" of the future.

1.5 Actor (Stakeholder) Roles

Describe all the people (their job), systems, databases, organizations, and devices involved in or affected by the Function (e.g. operators, system administrators, technicians, end users, service personnel, executives, SCADA system, real-time database, RTO, RTU, IED, power system). Typically, these actors are logically grouped by organization or functional boundaries or just for collaboration purpose of this use case. We need to identify these groupings and their relevant roles and understand the constituency. The same actor could play different roles in different Functions, but only one role in one Function. If the same actor (e.g. the same person) does play multiple roles in one Function, list these different actor-roles as separate rows.

<i>Grouping (Community)</i>		<i>Group Description</i>
<p><i>Users of Contingency Analysis (CA) for off-line power system security studies, and related actors.</i></p> <p><i>Note that "security" means the safe (equipment will not be damaged) and stable (the power system will remain up and running) operation of the electric power system.</i></p>		<p><i>Users of Contingency Analysis in an off-line (non real-time) "study" mode or environment for (a) power system planning (changes or expansion), or for (b) equipment outage planning and scheduling. Typically they use the Energy Management System (EMS) workstations outside the control room, or sometimes they use separate computer facilities. This Group includes related actors for these users.</i></p>
<i>Actor Name</i>	<i>Actor Type (person, device, system etc.)</i>	<i>Actor Description</i>
SystemPlanner	Person	Prime actor and off-line CA user. Engineer who studies the power system to ensure overall system security, with the ability to withstand at least the first major contingency (failure event). Assists with planning and evaluating changes to the power system, such as the addition of substations and transmission lines.
EquipmentOutagePlanner and Scheduler	Person	Prime actor and off-line CA user. Engineer who responds to outage requests from field maintenance personnel ("can I take this equipment out of service from XX to YY date?" by evaluating the impact on power system security if the equipment is withdrawn. Schedules equipment outages for minimum risk (to avoid same-time outages of key equipment), approves outage requests for execution by operators,

<i>Grouping (Community)</i>		<i>Group Description</i>
<p><i>Users of Contingency Analysis (CA) for off-line power system security studies, and related actors.</i></p> <p><i>Note that "security" means the safe (equipment will not be damaged) and stable (the power system will remain up and running) operation of the electric power system.</i></p>		<p><i>Users of Contingency Analysis in an off-line (non real-time) "study" mode or environment for (a) power system planning (changes or expansion), or for (b) equipment outage planning and scheduling. Typically they use the Energy Management System (EMS) workstations outside the control room, or sometimes they use separate computer facilities. This Group includes related actors for these users.</i></p>
<i>Actor Name</i>	<i>Actor Type (person, device, system etc.)</i>	<i>Actor Description</i>
		and assists with the preparation of the annual maintenance schedule for the complete power system.
CA User (SM)	Person	<p>Generic "stand-in" user actor for the SM = study mode, representing either of the main off-line CA users – the power system planner or the equipment outage planner/Scheduler.</p> <p>For simplicity, this generic actor is used in the sequence steps for the CA off-line study mode.</p>
EnergyManagementSystem	Computer system (single machine or distributed network based)	<p>The computer system that supports computation through various applications (including Contingency Analysis), the user interface (displays), data input and output, communications (internal and external), storage in its databases, and other functions.</p> <p>The EnergyManagementSystem is an actor in the sense that it is responsible for the control and execution of these many functions, including CA.</p>
EMSDatabase	Stored information in computer memory or on media	<p>Main repository of the real-time and static information used by Contingency Analysis and its human actors, and by other EMS applications. Responsible for:</p> <ul style="list-style-type: none"> • finding, organizing, storing and providing the data requested by CA and other

<i>Grouping (Community)</i>		<i>Group Description</i>
<p><i>Users of Contingency Analysis (CA) for off-line power system security studies, and related actors.</i></p> <p><i>Note that "security" means the safe (equipment will not be damaged) and stable (the power system will remain up and running) operation of the electric power system.</i></p>		<p><i>Users of Contingency Analysis in an off-line (non real-time) "study" mode or environment for (a) power system planning (changes or expansion), or for (b) equipment outage planning and scheduling. Typically they use the Energy Management System (EMS) workstations outside the control room, or sometimes they use separate computer facilities. This Group includes related actors for these users.</i></p>
<i>Actor Name</i>	<i>Actor Type (person, device, system etc.)</i>	<i>Actor Description</i>
		<ul style="list-style-type: none"> • applications, and needed by the user displays, and storage of CA results. <p>The EMS databases provide the power system data (collected by the DAC application) including real-time information, and the State Estimator solutions for initializing CA studies that are based on the current operating conditions.</p>
ContingencyAnalysisSystem	Computer program(s) and displays	<p>The solution engine within the CA application that solves the network model for each contingency event, and calculates the CA results.</p> <p>Also includes user interface (UI) displays provided by the EMS and the CA application for data input and information output. Displays are used to set up and control the application, enter and modify input data, view results, and save/transfer results. Typically these are tabular/character displays, but advanced graphical presentations are sometimes used to assist the interpretation of results.</p>

<i>Grouping (Community)'</i>		<i>Group Description</i>
<i>Secondary actors who are involved with the use of Contingency Analysis (CA) for off-line and/or on-line power system security studies.</i>		<p><i>These secondary actors are probably less important for the model of high level communications and data exchanges. This is because they work in the background to interact with the primary actors, perform system support work, or represent "busy work" tasks (e.g. Input/Output among data sources) that are supported within the EMS architecture.</i></p> <p><i>Note: If this distinction between primary and secondary actors is not important for the model, then this group can be merged with the first group of "Users of CA ... and related actors".</i></p>
<i>Actor Name</i>	<i>Actor Type (person, device, system etc.)</i>	<i>Actor Description</i>
SystemPlanner	Person(s)	<p>Note: This description is included for background information only; this secondary actor does not need to be "modeled".</p> <p>Engineers and technicians who are responsible for power system planning. They provide change study requests to the power system planner (a CA user) in the form of planned modifications to the electric power system, using drawings and written specifications. These include changes such as system expansion and equipment upgrades due to load growth, reliability and security improvements, replacement of outdated equipment, and the addition of new transmission lines and generation facilities.</p>
FieldEquipment MaintenanceMg mtSystem	Person(s)	<p>Note: This description is included for background information only; this secondary actor does not need to be "modeled".</p> <p>Engineers and technicians who are responsible for power equipment maintenance (for generators, power lines, transformers, etc.) and preparation of the annual</p>

<i>Grouping (Community)</i>		<i>Group Description</i>
<i>Secondary actors who are involved with the use of Contingency Analysis (CA) for off-line and/or on-line power system security studies.</i>		<p><i>These secondary actors are probably less important for the model of high level communications and data exchanges. This is because they work in the background to interact with the primary actors, perform system support work, or represent "busy work" tasks (e.g. Input/Output among data sources) that are supported within the EMS architecture.</i></p> <p><i>Note: If this distinction between primary and secondary actors is not important for the model, then this group can be merged with the first group of "Users of CA ... and related actors".</i></p>
<i>Actor Name</i>	<i>Actor Type (person, device, system etc.)</i>	<i>Actor Description</i>
		<p>maintenance and outage plan. They request outage approvals from the outage planner and Scheduler (a CA user), in order to withdraw equipment from service for maintenance. These outages can range from a few hours to many months in duration.</p>
PowerNetworkModelEngineer	Person	<p>Note: This description is included for background information only; this secondary actor does not need to be "modeled".</p> <p>NetworkEngineer specialist, who maintains the model of the power system (used by CA and other control center applications) to keep it current, and consistent with the utility's and the neighboring utilities' configurations. Uses the future configurations of the power system (according to the annual maintenance plan) to define power network models for future studies.</p>
DatabaseAdministrator	Person(s)	<p>Note: This description is included for background information only; this secondary actor does not need to be "modeled".</p> <p>Database analyst who performs changes to, and resolves problems with, the various databases in the EMS that CA uses.</p>

<i>Grouping (Community)</i>		<i>Group Description</i>
<i>Secondary actors who are involved with the use of Contingency Analysis (CA) for off-line and/or on-line power system security studies.</i>		<p><i>These secondary actors are probably less important for the model of high level communications and data exchanges. This is because they work in the background to interact with the primary actors, perform system support work, or represent "busy work" tasks (e.g. Input/Output among data sources) that are supported within the EMS architecture.</i></p> <p><i>Note: If this distinction between primary and secondary actors is not important for the model, then this group can be merged with the first group of "Users of CA ... and related actors".</i></p>
<i>Actor Name</i>	<i>Actor Type (person, device, system etc.)</i>	<i>Actor Description</i>
ExternalComputerSystem	Devices	<p>Note: this may be a primary actor (grouped as a single actor for simplicity), and could be divided into systems that are within and outside the utility. However practically all external data is provided through the EMS databases.</p> <p>Sources of other data used by CA for its solutions. These include:</p> <ul style="list-style-type: none"> • other computer systems within the utility (e.g. power equipment parameters are stored in a different computer system), and • computer systems at other power utilities which provide necessary data about neighboring power systems, using data links and other communications methods.
DAC	Subsystem and application in the EMS or SCADA system	<p>Collects most of the real-time and wide area data for the EMS databases.</p> <p>Also, for on-line CA, DAC is the receiver and processor of control commands to field devices in the power system.</p> <p>Operators can use DAC to perform remedial actions, if these suggestions are part of the CA results (i.e open breakers, increase generation, etc.).</p>

Replicate this table for each logic group.

<i>Grouping (Community)</i>		<i>Group Description</i>
<p><i>Users of Contingency Analysis (CA) for on-line power system security studies and operations decision support, with related actors.</i></p> <p><i>Note that "security" means the safe (equipment will not be damaged) and stable (the power system will remain up and running) operation of the electric power system.</i></p>		<p><i>Users of Contingency Analysis in an on-line (almost real-time) environment, to support power system operations. Typically they use the Energy Management System in the control room. Group includes related actors for these users.</i></p> <p><i>Note - only the ADDITIONAL actors for on-line CA use are identified here. The other actors are the same as for the Groupings for off-line study use, and the secondary actors.</i></p>
<i>Actor Name</i>	<i>Actor Type (person, device, system etc.)</i>	<i>Actor Description</i>
SystemOperator	Person	<p>Primary user of on-line CA. Also called a "Dispatcher". Person who "operates" the power system using the DAC (data acquisition and control) application in the EMS and/or SCADA system. Typical operations include monitoring power flows and voltage levels, switching equipment in and out of service (opening and closing breakers and switches by remote control), adding and adjusting generation sources (by remote control or using voice communications to field operators) to match the loads, and managing the operating conditions of the power system in real-time.</p> <p>In many utilities operators use CA as a source of "preview" alarms (or warnings) to show the violations that could occur (or are imminent) as a result of a future equipment failure (contingency). CA runs periodically to "look ahead" at potential future problems.</p> <p>An equipment failure event can also trigger CA to execute in a real-time advisory mode for operations support, to provide these "preview" alarms or warnings in case of a next contingency event.</p> <p>A typical CA display is non-graphic and shows the operator a summary of violations with the name of each important contingency event. Details about specific violations and overloads are available in other tabular displays. In</p>

<i>Grouping (Community)</i>		<i>Group Description</i>
<p><i>Users of Contingency Analysis (CA) for on-line power system security studies and operations decision support, with related actors.</i></p> <p><i>Note that "security" means the safe (equipment will not be damaged) and stable (the power system will remain up and running) operation of the electric power system.</i></p>		<p><i>Users of Contingency Analysis in an on-line (almost real-time) environment, to support power system operations. Typically they use the Energy Management System in the control room. Group includes related actors for these users.</i></p> <p><i>Note - only the ADDITIONAL actors for on-line CA use are identified here. The other actors are the same as for the Groupings for off-line study use, and the secondary actors.</i></p>
<i>Actor Name</i>	<i>Actor Type (person, device, system etc.)</i>	<i>Actor Description</i>
		advanced EnergyManagementSystems, suggested remedial actions may be displayed as a list of procedures for operators to use to remedy overload situations.
OutageCoordinator	Person	<p>User of on-line CA. The outage coordinator manages the short-term weekly and daily equipment outage schedule, approves each scheduled outage before it is implemented by operators, and advises operators during the equipment withdrawal procedures.</p> <p>The outage coordinator may use CA as a "quick check" in the on-line mode using the current operating conditions, to make sure that a planned equipment outage will not create problems (violations and overloads). For this mode, easy setup and fast results (i.e. high performance) are necessary.</p>
NetworkEngineer	Person	<p>User of on-line CA. The network engineer is an expert in the power system who advises operators (usually upon request) before and during their execution of complex or unusual procedures. He also monitors the current operating conditions and the CA results.</p> <p>The network engineer may use CA as a "quick check" in the on-line mode, to validate procedures and try "what if" scenarios. Again, easy setup and fast results</p>

<i>Grouping (Community)</i>		<i>Group Description</i>
<p><i>Users of Contingency Analysis (CA) for on-line power system security studies and operations decision support, with related actors.</i></p> <p><i>Note that "security" means the safe (equipment will not be damaged) and stable (the power system will remain up and running) operation of the electric power system.</i></p>		<p><i>Users of Contingency Analysis in an on-line (almost real-time) environment, to support power system operations. Typically they use the Energy Management System in the control room. Group includes related actors for these users.</i></p> <p><i>Note - only the ADDITIONAL actors for on-line CA use are identified here. The other actors are the same as for the Groupings for off-line study use, and the secondary actors.</i></p>
<i>Actor Name</i>	<i>Actor Type (person, device, system etc.)</i>	<i>Actor Description</i>
		(i.e. high performance) are necessary.
CA User (OM)	Person	<p>Generic "stand-in" user actor for the OM = on-line mode, representing any of the main on-line CA users – the operator, outage coordinator, or network engineer.</p> <p>For simplicity, this generic actor is used in the sequence steps for the CA on-line mode.</p>
SystemPlanners		
SystemOperator		
NERC		

1.6 Information exchanged

Describe any information exchanged in this template.

<i>Information Object Name</i>	<i>Information Object Description</i>
Outage request	<p>Document form, electronic and paper</p> <p>The outage request is a form submitted by field maintenance personnel to the equipment outage planner and Scheduler. It requests approval to take equipment out of service for a defined period of time, for a specific reason. Sometimes the outage request includes an estimated "return to service time" if it is a short outage on critical equipment that might be quickly needed back in service.</p>
Outage approval	<p>Document form, electronic and paper</p> <p>Approval form issued by the outage planner and Scheduler, to approve the equipment outage and schedule it for a specified date/time/duration. Operations and maintenance personnel would then perform the equipment outage procedures.</p>
Change study request (study of a power system modification)	<p>Document drawing and description, electronic and paper</p> <p>Notice of a planned change to the power system (e.g. the addition of a substation) to be studied. The system planner reviews this change using CA, to evaluate the impacts on the modified configuration in case of contingency events (equipment failures).</p>
Change study report	<p>Document drawing and description, electronic and paper</p> <p>Report prepared by the system planner from the results of the CA study, which accepts, accepts with modifications, or requests further study about the planned change.</p>
Annual maintenance and outage plan (or similar names)	<p>Document, electronic and paper</p> <p>Plan used to schedule the un-availabilities for power system equipment. Consulted to determine future planned configurations of the power system. Used for studies of new outage requests and for risk assessment by operations. Is refined into monthly and weekly outage schedules throughout the year, to reflect current operating conditions of the power system.</p>
Network model	Stored files on computer media

<i>Information Object Name</i>	<i>Information Object Description</i>
	Static simulated model of the power system, used by CA and other EMS applications such as the power flow analysis. This model uses the parameters and characteristics of the real-world power system and "behaves" like the real system for the purposes of studies. Can be a model of the current power system, or of a future configuration of the power system.
Base case initial data	<p>Stored files on computer media + Manually entered data</p> <p>Data that CA obtains from the EMS databases in order to set up the network model before executing the analysis. Includes data that is entered manually by users.</p> <p>Sometimes the base case is for a study of a future operating condition of the power system, requiring a future "picture" of the network and its parameters.</p>
CA study model	<p>Temporary or stored file</p> <p>Network model that has been adjusted by the CA user, by removing or adding equipment until it represents the desired starting point for the CA study.</p>
Contingency list	<p>Document, electronic and paper and Temporary or stored file</p> <p>List of contingency events (equipment outages) that is prepared by the CA user, and input to CA as the list of events to evaluate. Typically a base contingency list is retrieved from the EMS database and manually enabled and modified by the user (on displays) before it is ready for CA to use.</p> <p>These lists can range from a few selected items of power system equipment, to thousands of elements of the power system. They are the "test scripts" for CA execution.</p>
Execution parameters	<p>Stored files on computer media + Manually entered data</p> <p>Control parameters (enable or disable certain features of the application, and enter values) that the CA user selects from menus or enters manually, to set up the behavior and functionality of the application.</p>
Screened contingency list	<p>Document, electronic and paper, and Temporary or stored file</p> <p>List of the most serious equipment outages that are selected by the CA screening process (or manually selected by the CA user) to undergo a complete analysis to determine the severity of violations and</p>

<i>Information Object Name</i>	<i>Information Object Description</i>
	overloads.
CA results	<p>Document forms and graphic pictures, electronic and paper</p> <p>Lists of bus voltage violations and branch overloads, shown in displays and on printouts. Typically these results consist of long lists of numbers sorted by priority – worst case violations/overloads are shown at the top of the list. New visualization technology incorporates graphic pictures for easier interpretation of results.</p> <p>CA users also provide written reports to summarize these results for other departments.</p>
Stored CA results	<p>Data files</p> <p>CA study results are stored in the EMS databases for review by system planning, outage scheduling, and operations personnel. They can also be accessed by or transferred to the Training Simulator, for use in building training scenarios for operations personnel.</p>
CA error messages	<p>Temporary or stored file</p> <p>The CA application issues notification to the users of any problems with its execution, so that the user can adjust the model or provide additional data inputs to correct the problem.</p>
CA warnings and alarms	<p>Temporary or stored file</p> <p>For on-line users the CA application can issue warning messages and even audible alarms, to notify operators about overloads or violations that WOULD occur IF certain contingency events happen in future. These are essentially "preview" warnings or alarms about the effects of possible future events.</p>
Remedial action suggestions	<p>Temporary or stored file</p> <p>In some advanced implementations of baseline current Contingency Analysis, the application can</p>

<i>Information Object Name</i>	<i>Information Object Description</i>
	provide suggestions for operators to correct potential overloads and violations. These would typically consist of suggestions to adjust or add generation, reduce load, adjust power system voltage levels, add reactive VAR resources, isolate a problem area, etc.

1.7 Activities/Services

Describe or list the activities and services involved in this Function (in the context of this Function). An activity or service can be provided by a computer system, a set of applications, or manual procedures. These activities/services should be described at an appropriate level, with the understanding that sub-activities and services should be described if they are important for operational issues, automation needs, and implementation reasons. Other sub-activities/services could be left for later analysis.

<i>Activity/Service Name</i>	<i>Activities/Services Provided</i>
Identify the most serious contingencies for detailed analysis	Contingency Analysis (CA) performs a quick screening of the hundreds or even thousands of possible equipment outages (contingencies), and identifies the few (typically 10-50) that would have the worst effects on the power system.
Analyze the most serious contingencies and quantify the effects of each	CA performs a complete analysis of the most serious contingencies, to calculate the magnitude of branch overloads and voltage violations for individual elements of the power system. These "what if" simulations are the main tool for ensuring secure power system operation in case of equipment failures or planned equipment outages.
Organize the analysis results (by severity) and display them to users (both on-line and off-line use)	CA presents the overloads and violations in order of their severity, in tabular lists. These are displayed and can be stored for reference. For on-line use by operators, summary displays show highlights of the CA results, such as the names of contingency events that would result in severe overloads, and the number of these overloads.
Issue warnings and alarms to	CA issues warning and alarm messages to power system operators, to alert them about the effects of

<i>Activity/Service Name</i>	<i>Activities/Services Provided</i>
operators (on-line use)	future contingency events (i.e. a preview) that would result in branch overloads and voltage violations.
Save results and cases for reference	CA users can save results and the study cases (power system conditions), for future review.
Transfer study cases to the operator training simulator for use in training	CA users can send interesting study cases to the operator training simulator, for use in training scenarios.

1.8 Contracts/Regulations

Identify any overall (human-initiated) contracts, regulations, policies, financial considerations, engineering constraints, pollution constraints, and other environmental quality issues that affect the design and requirements of the Function.

<i>Contract/Regulation</i>	<i>Impact of Contract/Regulation on Function</i>
Deregulation and competition (FERC Orders 888 and 889, etc.)	May restrict the sharing of power system data (especially equipment unavailabilities) among competing utilities (and related companies), which could limit the Contingency Analysis solutions to the "observable" network, instead of a wider area solution.

<i>Policy</i>	<i>From Actor</i>	<i>May</i>	<i>Shall Not</i>	<i>Shall</i>	<i>Description (verb)</i>	<i>To Actor</i>
NERC Operating Policy 2.A – Transmission Operations	NERC			X	Operate the power system in a secure and reliable manner, using security analysis tools to recognize and avoid problem conditions. "All control areas shall operate so that instability, uncontrolled separation, or cascading outages will not occur as a result of the most severe single contingency." (voluntary reliability guidelines and standards for utilities)	SystemPlanners and SystemOperator

<i>Constraint</i>	<i>Type</i>	<i>Description</i>	<i>Applies to</i>
Thermal limits of power system equipment	Engineering	Flow limits (maximum current and MW) to be respected in order to avoid damage to, or premature aging of, power system equipment (such as generators, transmission lines, transformers, breakers, etc.). Used by CA to calculate overloads.	ContingencyAnalysisSystem
Stability limits for transmission lines and corridors	Engineering	Flow limits (maximum MW and MVA) for transmission lines and corridors, to be respected in order to maintain power system stability. Used by CA to calculate overloads.	ContingencyAnalysisSystem
Voltage limits	Engineering	Voltage limits on buses (high and low) to be respected in order to maintain secure and stable operation of the power system. Used by CA to calculate violations.	ContingencyAnalysisSystem

Need for fast solutions (a)	Performance of the application (computer resources)	For on-line use by power system operators (decision support), CA must provide fast solutions, within seconds of an event. Current (2004) computer resources can meet this constraint.	EnergyManagementSystem
Need for fast solutions (b)	Performance of the application (application design)	For on-line use by power system operators (decision support), CA must provide fast solutions, within seconds of an event. Current (2004) CA application barely meets this constraint.	ContingencyAnalysisSystem
Need for robust application	Reliability of the application (application design and features)	For both off-line and on-line use, CA must be reliable – it must provide solutions even in difficult situations with limited input data.	ContingencyAnalysisSystem
Need for ease-of-use of the application	Usability of the application (application design and user interface)	In order to be useful for on-line analysis and decision support, the CA application must be easy to use, without requiring a programmer's skills.	ContingencyAnalysisSystem
Need for fast analysis of the results	Usability of the application (application design and results presentation)	The CA application must present its voluminous numeric results in a manner that can be quickly understood by users, especially for on-line use. This requires summary displays and graphical displays that are designed for easier interpretation.	ContingencyAnalysisSystem

2 Step by Step Analysis of Function

Describe steps that implement the function. If there is more than one set of steps that are relevant, make a copy of the following section grouping (Preconditions and Assumptions, Steps normal sequence, and Steps alternate or exceptional sequence, Post conditions)

2.1 Steps to implement function

Name of this sequence.

Contingency Analysis Off-line Study Mode Sequence (SM)

2.1.1 Preconditions and Assumptions

Describe conditions that must exist prior to the initiation of the Function, such as prior state of the actors and activities

Identify any assumptions, such as what systems already exist, what contractual relations exist, and what configurations of systems are probably in place

Identify any initial states of information exchanged in the steps in the next section. For example, if a purchase order is exchanged in an activity, its precondition to the activity might be 'filled in but unapproved'.

<i>Actor/System/Information/Contract</i>	<i>Preconditions or Assumptions</i>
EMSDatabase	The EMS databases must contain current power system and other data needed by CA, such as the State Estimator solutions for initial data.
Network model	The network model must reflect the current or other situation of the power system that will be studied.

2.1.2 Steps – Normal Sequence

Describe the normal sequence of events, focusing on steps that identify new types of information or new information exchanges or new interface issues to address. Should the sequence require detailed steps that are also used by other functions, consider creating a new “sub” function, then referring to that “subroutine” in this function. Remember that the focus should be less on the algorithms of the applications and more on the interactions and information flows between “entities”, e.g. people, systems, applications, data bases, etc. There should be a direct link between the narrative and these steps.

The numbering of the sequence steps conveys the order and concurrency and iteration of the steps occur. Using a Dewey Decimal scheme, each level of nested procedure call is separated by a dot ‘.’. Within a level, the sequence number comprises an optional letter and an integer number. The letter specifies a concurrent sequence within the next higher level; all letter sequences are concurrent with other letter sequences. The number specifies the sequencing of messages in a given letter sequence. The absence of a letter is treated as a default ‘main sequence’ in parallel with the lettered sequences.

Sequence 1:

*1.1 - Do step 1
1.2A.1 - In parallel to activity 2 B do step 1
1.2A.2 - In parallel to activity 2 B do step 2
1.2B.1 - In parallel to activity 2 A do step 1
1.2B.2 - In parallel to activity 2 A do step 2
1.3 - Do step 3
1.3.1 - nested step 3.1
1.3.2 - nested step 3.2*

Sequence 2:

*2.1 - Do step 1
2.2 - Do step 2*

Contingency Analysis Off-line Study Mode Sequence = CA-SM steps

#	Event	Primary Actor	Name of Process/Activity	Description of Process/Activity	Information Producer	Information Receiver	Name of Info Exchanged	Additional Notes	IECSA Environments
#	<i>Triggering event? Identify the name of the event.¹</i>	<i>What other actors are primarily responsible for the Process/Activity? Actors are defined in section 1.5.</i>	<i>Label that would appear in a process diagram. Use action verbs when naming activity.</i>	<i>Describe the actions that take place in active and present tense. The step should be a descriptive noun/verb phrase that portrays an outline summary of the step. "If ...Then...Else" scenarios can be captured as multiple Actions or as separate steps.</i>	<i>What other actors are primarily responsible for Producing the information? Actors are defined in section 1.5.</i>	<i>What other actors are primarily responsible for Receiving the information? Actors are defined in section 1.5. (Note – May leave blank if same as Primary Actor)</i>	<i>Name of the information object. Information objects are defined in section 1.6</i>	<i>Elaborate architectural issues using attached spreadsheet. Use this column to elaborate details that aren't captured in the spreadsheet.</i>	<i>Reference the applicable IECSA Environment containing this data exchange. Only one environment per step.</i>
1.1	Outage request Or Change study request (can split these later into separate sequences if necessary, but each request initiates the same steps)	FieldEquipmentMaintenanceMgmtSystem Or SystemPlanner	Initiate CA study	Initiates the Contingency Analysis study, by: <ul style="list-style-type: none"> a request for off-line analysis of an equipment outage request or a change (to the power system) request 	FieldEquipmentMaintenanceMgmtSystem, SystemPlanner	CA User (SM)	Outage request, Change study request	CA User (SM) (a generic user to represent the EquipmentOutagePlanner and Scheduler, or the SystemPlanner)	Intra-control center

¹ Note – A triggering event is not necessary if the completion of the prior step – leads to the transition of the following step.

#	Event	Primary Actor	Name of Process/Activity	Description of Process/Activity	Information Producer	Information Receiver	Name of Info Exchanged	Additional Notes	IECSA Environments
1.2		CA User (SM)	Set up CA study	<p>CA user sets up the CA study, by using CA displays to feed/input/acquire the necessary network model and data from the EMS databases, and by using manual entries.</p> <p>Notes:</p> <ul style="list-style-type: none"> • several elements of data are required to "set up" a CA study; • these elements can be acquired from many sources, however all necessary data is available through the EMS databases; • this process becomes more complex for a future study case 	EMSDatabase , ExternalComputerSystem, DAC	ContingencyAnalysisSystem	Network model, Base case initial data	Communications issues: interfaces and data exchange and performance	Intra-control center

#	Event	Primary Actor	Name of Process/Activity	Description of Process/Activity	Information Producer	Information Receiver	Name of Info Exchanged	Additional Notes	IECSA Environments
1.3		CA User (SM)	Adjust the network model	CA user adjusts the network model to represent the power system configuration to be studied. The user performs this by manually removing equipment from a base configuration, or possibly by adding equipment.	CA User (SM)	ContingencyAnalysisSystem	CA study model	Communications issues: may need access to stored future data and historical data	Intra-control center
1.4		CA User (SM)	Define contingency list to be used	CA user defines the list of contingency events to be used in the study. Includes making manual adjustments to stored lists retrieved from the EMS database. This list could range from a few outages to be evaluated, to thousands of outages to be simulated.	EMSDatabase	ContingencyAnalysisSystem	Contingency list		Intra-control center
1.5		CA User (SM)	Set CA execution parameters	CA user sets the CA execution control parameters, to define constraints and outputs.	CA User (SM)	ContingencyAnalysisSystem	Execution parameters		Intra-control center

#	Event	Primary Actor	Name of Process/Activity	Description of Process/Activity	Information Producer	Information Receiver	Name of Info Exchanged	Additional Notes	IECSA Environments
1.6	CA user starts contingency screening process ("start" button)	ContingencyAnalysisSystem	Screen for worst contingencies	CA application performs a quick check to screen (identify) the worst contingencies, and displays these to the user. Note: users may choose to skip this step and instruct the application to proceed directly to the "complete analysis" step 1.7.	ContingencyAnalysisSystem	CA User (SM)	Screened contingency list		Intra-control center
1.7	CA user starts complete analysis for the worst contingencies	ContingencyAnalysisSystem	Perform complete analysis of the worst contingencies	CA application performs a complete analysis of the worst contingencies, to calculate and display the branch overloads and voltage violations for each outage.	ContingencyAnalysisSystem	CA User (SM)	CA results	Performance and visualization issues	Intra-control center
1.8		CA User (SM)	Reviews and interprets CA results	CA user reviews and interprets the CA results. Typically results are presented in summary tabular displays, however graphic display techniques can assist interpretation of voluminous results.				Presentation and visualization issues	Intra-control center

#	Event	Primary Actor	Name of Process/Activity	Description of Process/Activity	Information Producer	Information Receiver	Name of Info Exchanged	Additional Notes	IECSA Environments
1.9		CA User (SM)	Saves results	CA user initiates the printing and "save" of CA results in the EMS databases. User may transfer the CA study model and results to the Training Simulator (an external system).	CA User (SM)	EMS Database, External Computer System	CA results	Communications issues: interfaces and data exchange	Intra-control center
1.10		CA User (SM)	Issues report	CA user issues report based on the CA results: an outage approval, or a report on the effects of the proposed change to the power system. Report templates and forms are typically available from the CA application and EMS. May also affect the annual maintenance and outage plan.	CA User (SM)	Field Equipment Maintenance Mgmt System, System Planner	Outage approval, Change study report		Intra-control center

2.1.3 Steps – Alternative / Exception Sequences

Describe any alternative or exception sequences that may be required that deviate from the normal course of activities. Note instructions are found in previous table.

#	Event	Primary Actor	Name of Process/Activity	Description of Process/Activity	Information Producer	Information Receiver	Name of Info Exchanged	Additional Notes	IECSA Environments
1.7.1	CA solution fails	ContingencyAnalysisSystem	Alerts user of failure to solve	CA display alerts the CA user when it cannot solve the network model, usually because of incomplete or faulty data.	ContingencyAnalysisSystem	CA User (SM)	CA error messages	Application robustness and problem diagnostic issues	Intra-control center
1.7.2		CA User (SM)	Adjust CA input data	CA user (with help from network model engineer and/or database support analyst) adjusts CA input data and/or the network model to fix the problem. Usually involves manual entry of data corrections.	PowerNetworkModelEngineer, DatabaseAdministrator	ContingencyAnalysisSystem	Base case initial data, CA study model	Application robustness and problem diagnostic issues	Intra-control center
1.7.3	Return to regular CA-SM sequence			After problems are resolved, the regular CA-SM sequence continues. Go back to step 1.7					NA

2.1.4 Post-conditions and Significant Results

Describe conditions that must exist at the conclusion of the Function. Identify significant items similar to that in the preconditions section.

Describe any significant results from the Function

<i>Actor/Activity</i>	<i>Post-conditions Description and Results</i>
	See CA-SM. 10 above – immediate results of off-line CA are in the form of an outage approval, or a study report on the proposed change to a power system configuration.
	Overall result of contingency analysis: a secure and stable power system, even after contingency events occur.

START A SECOND SEQUENCE:

2.1.5 Steps to implement function

Name of this sequence.

Contingency Analysis On-line Operations Mode Sequence (OM)

Note: This mode of use of Contingency Analysis is very similar to the off-line study mode, except that:

- the users are the power system operators in the control center, outage coordinators who manage the planned withdrawal of equipment from the power system, and network engineers who provide advisory support to the operators
- the application runs continuously in the background, providing its results (a preview of contingency effects) to operators with updates at every execution cycle (usually every few minutes)
- the application looks at contingencies starting with the current operating situation (not future situations), and uses the current power system data and State Estimator data to initiate its network model
- operators typically do not interact with the application or initiate their own studies; it is more of a "look only" advisory tool
- the on-line CA provides visual warnings and even audible alarms to operators, to notify them of overloads and violations that would occur if certain contingency events happen in future (i.e. a "what if" preview of the effects of future outages)
- Baseline CA does not usually extend to providing suggested lists of remedial actions, which could be performed by operators to correct potential problems.

2.1.6 Preconditions and Assumptions

Same as 2.1.1 above.

2.1.7 Steps – Normal Sequence

Contingency Analysis On-line Operations Mode Sequence = CA-OM steps

#	Event	Primary Actor	Name of Process/Activity	Description of Process/Activity	Information Producer	Information Receiver	Name of Info Exchanged	Additional Notes	IECSA Environments
#	<i>Triggering event? Identify the name of the event.²</i>	<i>What other actors are primarily responsible for the Process/Activity? Actors are defined in section 1.5.</i>	<i>Label that would appear in a process diagram. Use action verbs when naming activity.</i>	<i>Describe the actions that take place in active and present tense. The step should be a descriptive noun/verb phrase that portrays an outline summary of the step. "If ...Then...Else" scenarios can be captured as multiple Actions or as separate steps.</i>	<i>What other actors are primarily responsible for Producing the information? Actors are defined in section 1.5.</i>	<i>What other actors are primarily responsible for Receiving the information? Actors are defined in section 1.5. (Note – May leave blank if same as Primary Actor)</i>	<i>Name of the information object. Information objects are defined in section 1.6</i>	<i>Elaborate architectural issues using attached spreadsheet. Use this column to elaborate details that aren't captured in the spreadsheet.</i>	<i>Reference the applicable IECSA Environment containing this data exchange. Only one environment per step.</i>
2.1	Periodic "start CA" command from the execution control program	EnergyManagementSystem	Initiate on-line CA execution	Initiates the Contingency Analysis in periodic cycles (typically every few minutes) using the application execution control program (security analysis sequence).				Communications issues: gather data fast enough to support on-line use of CA	NA

² Note – A triggering event is not necessary if the completion of the prior step – leads to the transition of the following step.

#	Event	Primary Actor	Name of Process/Activity	Description of Process/Activity	Information Producer	Information Receiver	Name of Info Exchanged	Additional Notes	IECSA Environments
2.2	CA results presented to users	ContingencyAnalysisSystem	Present on-line CA results	Presents the on-line CA results in displays for the users to consult and monitor; revised results are presented after every CA execution cycle, typically every few minutes	ContingencyAnalysisSystem	CA User (OM)	CA results, CA warnings and alarms, Remedial action suggestions	Presentation and visualization issues	Intra-control center
2.3	User action	CA User (OM)	Action by users of on-line CA	<p>CA on-line users may react to the CA results and remedial action suggestions by:</p> <ul style="list-style-type: none"> • SystemOperator: Planning remedial actions, to be ready if a contingency event occurs • OutageCoordinator and NetworkEngineer: Implementing or postponing a scheduled outage • SystemOperator: Making remedial action changes to the power system to reduce exposure to problems in case of a contingency event 	CA User (OM)	DAC, FieldEquipmentMaintenanceMgmtSystem		Communications issues: output commands to DAC and field devices	Intra-control center

2.1.8 Steps – Alternative / Exception Sequences

N/A

2.1.9 Post-conditions and Significant Results

Describe conditions that must exist at the conclusion of the Function. Identify significant items similar to that in the preconditions section.

Describe any significant results from the Function

<i>Actor/Activity</i>	<i>Post-conditions Description and Results</i>
	See CA-OM.2 above – immediate results of on-line CA are in the form of CA results (summaries of overloads and violations), CA warnings and alarms for operators, and (possibly) remedial action suggestions for operators.
	Overall result of contingency analysis: a secure and stable power system, even after contingency events occur.

2.2 Architectural Issues in Interactions

Elaborate on all architectural issues in each of the steps outlined in each of the sequences above. Reference the Step by number.



Microsoft Excel
Worksheet

2.3 Diagram

For clarification, draw (by hand, by Power Point, by UML diagram) the interactions, identifying the Steps where possible.

3 Auxiliary Issues

3.1 References and contacts

Documents and individuals or organizations used as background to the function described; other functions referenced by this function, or acting as “sub” functions; or other documentation that clarifies the requirements or activities described. All prior work (intellectual property of the company or individual) or proprietary (non-publicly available) work must be so noted.

ID	Title or contact	Reference or contact information
[1]		
[2]		

3.2 Action Item List

As the function is developed, identify issues that still need clarification, resolution, or other notice taken of them. This can act as an Action Item list.

ID	Description	Status
[1]		
[2]		

3.3 Revision History

For reference and tracking purposes, indicate who worked on describing this function, and what aspect they undertook.

No	Date	Author	Description
0.7	December 4, 2003	J. Bobyne	<p>Incomplete draft of the V1.28 template for Contingency Analysis - Baseline, sections 1 through 1.8, and sections 2.1 through 2.1.3 for the first sequence (Contingency Analysis Off-line Study Mode).</p> <p>Still to be done:</p> <ul style="list-style-type: none"> • Revise the Narrative section 1.4 (was written earlier) to track more closely with the remainder • Complete section 2.1.4 for the first sequence • Complete the steps sections 2.1 through 2.1.4 for the second sequence (Contingency Analysis On-line Operations Mode) but showing only the differences from the first sequence • Complete sections 2.2, 2.3 and 3 (the table in 2.2 will require analysis before it can be filled in accurately; the diagram in 2.3 will have to be produced by others) • Re-iterate and edit all above sections as necessary for consistent terminology, closed loops for the steps model, and to reflect comments and discussion and validation by other team members • Re-do another template for "CA future usage", showing enhancements and new requirements <p>Dec. 5 review: Grant said to make some "paper" actors into data = information exchanged – this may cause adjustments to be needed elsewhere TBD, AND add a list of shortcomings in current CA at the end of the narrative section 1.4.7</p>
0.8	December 10, 2003	J. Bobyne	<p>Completed:</p> <ul style="list-style-type: none"> • section 2.1.4 for the first sequence (Off-line mode) • sections 2.1.5 to 2.1.9 for second Sequence (On-line mode) <p>and reviewed the Tables in section 2.2 for orientation and study of reference material</p>
0.9	December 17, 2003	J. Bobyne	<p>Completed Rev. 0.9 for initial posting to project site and review/comments:</p> <ul style="list-style-type: none"> • Added list of CA shortcomings in Narrative section 1.4.7 • Added Tables (Architectural issues) in section 2.2 for the first sequence (off-line

No	Date	Author	Description
			<p>mode) only</p> <ul style="list-style-type: none"> • Changed paper and data actors (forms, reports, etc.) to make them "Information exchanged", and rewrote the steps accordingly, with other minor edits elsewhere where needed <p>Still to be done:</p> <ul style="list-style-type: none"> • Revise the Narrative section 1.4 (was written earlier) to track more closely with the other sections • Complete the Table in section 2.2 for the On-line mode • Provide a draft of a process/data flow diagram in section 2.3 • Re-iterate and edit all sections as necessary for consistent terminology, and to reflect comments and discussion and validation by other team members and utilities • Re-do another template for "CA future usage", showing enhancements and new requirements
0.95	February 27, 2004	J. Bobyne	<p>Completed Rev. 0.95 for posting to project site.</p> <ul style="list-style-type: none"> • Performed significant edits and changes according to reviews with Grant Gilchrist • Still needs a process/data flow diagram for section 2.3 to be complete Rev. 1.0

This page intentionally left blank.

Contingency Analysis – Future (advanced)

1 Descriptions of Function

All prior work (intellectual property of the company or individual) or proprietary (non-publicly available) work should be so noted.

1.1 Function Name

Contingency Analysis – Future (advanced)

1.2 Function ID

IECSA identification number of the function

G-4.4,G-4.5,G-4.6,G-5.9.2,G-5.9.3,G-5.9.4

1.3 Brief Description

Describe briefly the scope, objectives, and rationale of the Function.

In layman's terms, Contingency Analysis (CA) is a "what if" scenario simulator that evaluates, provides and prioritizes the impacts on an electric power system when problems occur. A contingency is the loss or failure of a small part of the power system (e.g. a transmission line), or the loss/failure of individual equipment such as a generator or transformer. This is also called an unplanned "outage". Contingency analysis is a computer application that uses a simulated model of the power system, to:

- evaluate the effects, and
- calculate any overloads,

resulting from each outage event.

Contingency Analysis is essentially a "preview" analysis tool. It simulates and quantifies the results of problems that could occur in the power system in the immediate future.

CA is used as a study tool for the off-line analysis of contingency events, and as an on-line tool to show operators what would be the effects of future outages. This allows operators to be better prepared to react to outages by using pre-planned recovery scenarios.

Future CA as described in this use case template is an enhanced application that takes advantage of the improved communications architecture being defined by IECSA for the future. It will use wide area data and other data to improve its reliability, and to analyze

power system security (safe and stable operation) for a wide operating region. Future CA will also incorporate intelligence features to resolve execution problems by using its knowledge base of previous experience in solving difficult situations.

1.4 Narrative

A complete narrative of the Function from a Domain Expert's point of view, describing what occurs when, why, how, and under what conditions. This will be a separate document, but will act as the basis for identifying the Steps in Section 2.

Note: This narrative assumes that the reader has already reviewed the use case template for Contingency Analysis – Baseline (current usage), and is therefore familiar with the terminology and the functions of this application for power system security analysis.

1.4.1 Introduction

Contingency analysis (CA) is an Energy Management System (EMS) application that analyzes the security (i.e. the safe and stable operation) of a power system. It calculates, identifies and prioritizes the:

- current and power flow overloads in equipment,
- voltage violations at buses, and
- some system stability problems

that would occur if contingency events (i.e. equipment failures or outages) happen in the future. Contingency analysis simulates the effects of removing equipment, one by one, and calculates the results using a model of the power system. CA is essentially a "what if" problem identification tool that is used for off-line studies by system planners and outage schedulers, and for on-line support by system operators.

This narrative describes an advanced contingency analysis application ("Future CA") that can be achieved in the near future, possibly before 2010. This application will have features and performance that together address some of the CA shortcomings that are reviewed in the narrative for today's CA of 2004. For details of these deficiencies, refer to the use case template for Contingency Analysis – Baseline.

Some of these CA shortcomings (and therefore its requirements) can be addressed with an improved communications architecture, which will support the use of more, more frequent, higher quality, and wider-area data. This will enhance CA to form one of the tools necessary for the future "self-healing grid" that the IECSA project is helping to define.

In the list below, the CA shortcomings that are candidates for significant or partial improvement due to an advanced communications architecture are marked with an asterisk (*).

Problems that exist in many current implementations of Contingency Analysis include:

- (a) Lack of Reliability and Robustness in the CA solution "engine" (* partial)
- (b) Usability – difficult to set up and use CA (* partial)
- (c) Difficult for users to interpret the avalanche of numeric CA results
- (d) Restricted visibility - not always a "wide area" or regional solution, and does not always "see" accurate topology (*)
- (e) Few or no remedial action suggestions for operators (* partial)
- (f) Slow performance
- (g) No intelligence or learning from previous cases (* partial)
- (h) Relatively isolated application, no links with Equipment Condition Monitoring or Phase Angle telemetry (*)
- (i) Rarely coupled with the SystemOperator Training Simulator (* partial)

This use case template for Future CA will focus on the CA improvements that will come from using a communications architecture that is being defined in the IECSA project. This advanced architecture is a prerequisite for building the integrated tools that are needed to achieve a self-healing grid.

1.4.2 Future CA improvements

1.4.2.1 Wide area CA and requirements

The Future CA will be improved by the use of an advanced communications architecture that supports the considerably increased acquisition, sharing and exchange of information and data among utilities, ISOs, and RTOs. This will allow the exchange of the extensive data needed for input to a "wide area network model" which can essentially be common to all participants.

Each utility can then have a "view" of a wide area that extends beyond its service area into a larger control area, or a complete operating region. The contingency analysis will therefore be able to show and quantify the effects of contingency events that may occur outside each utility's immediate service area, but that can affect the local operating conditions.

The size of this network model, and the corresponding data and contingency events requirements for wide area CA, will be typically 10 times those of the current baseline CA. Targets include a model size of 20,000 buses, supported by 50,000 data points, and screening 10,000 contingencies.

The communications architecture must also provide very fast acquisition of this extensive data from its many widespread sources (collection target within 10 seconds) while ensuring the time coherency of the data ("skew" target within 5 seconds). The referential integrity of data with its source, quality, time and other attributes must be preserved during its acquisition and possibly afterwards for storage.

Wide area CA will require much higher performance than baseline CA so that contingency analysis runs essentially in real time, even with the wide area network model. The target will be to provide CA results for the most severe contingencies every 20 seconds, which is necessary for its effective on-line use by operators.

A wide area CA will make possible (and essential) the coordination of regional remedial actions by each utility, for mutual security benefits. Studies can be performed on the most likely and most serious contingencies over a wide area, to identify and test the best recovery scenarios. Then remedial action "scripts" can be prepared and used in a coordinated mode by each utility, based on the wide area simulation. In some conditions coordinated remedial actions over a wide area may be more effective than local actions, to maintain overall power system security and stability.

Regional authorities such as ISOs already employ a basic form of wide area CA. The Midwest ISO (MISO) uses a very large network model (over 30,000 buses), based on wide area data (over 80,000 data points) obtained through several Inter Control Center Protocol (ICCP) data links. This MISO CA performs reasonably fast studies of wide area power system security, for operations support. It executes less frequently than the State Estimator, which typically runs every 5 minutes, according to the Interim Report on the August 2003 Blackout. However it is a significant step toward the wide area CA of the future, because it allows the CA to "see" and evaluate contingency effects over a very large operating region.

Wide area CA will therefore require significant improvements in data gathering capability from many sources, and in data exchange among all the utilities in a region. Additional needs include fast performance, tight time coherency and data integrity. These requirements can be met with an advanced communications architecture.

Wide area CA will be an improvement over the current baseline CA that has restricted visibility of power system contingency effects throughout an operating region. This is one of the operational problems described in the Interim Report on the August 2003 Blackout.

1.4.2.2 CA with improved topology data ("deeper CA")

The CA algorithm works best (i.e. does not have problems solving) when:

- the network model is correct (i.e. the model represents the real connectivity or topology of power system equipment), and

- it uses accurate base case data for that model (for a current "now" CA study, usually the State Estimator results are the most dependable).

Problems occur when the network model is different from the real-world power system. This can be caused by incorrect topology being reported (due to transducer wiring errors, or incorrect status is manually entered or reported by phone from the field) or being deduced from SCADA data. In this case the network model and the initial base case data do not match properly, and CA may encounter problems such as failing to solve. Experts can usually fix the problem by adjusting the model or its data, but this takes time - often many minutes, and sometimes hours. Then CA loses its relevance as an on-line tool for operators.

But better topology data is often available, which could be used by CA. In many power utilities that use hierarchical control centers, the Energy Management System (EMS) where the CA executes does not "see" all the sub-transmission and distribution SCADA data that the regional or distribution control centers have available from the substations and field. Only a subset of the field data (from the higher voltage part of the system) is sent to the EMS, either reported from its own RTUs, or more typically sent using separate "EMS" scan maps within multi-purpose RTUs. The majority of the field data is sent to other lower level monitoring and control systems such as regional and distribution SCADA.

However this lower level field data contains valuable information that can be used by the EMS to correctly deduce or confirm the connectivity and status of substation and other field equipment, essentially by a "local estimation" or by using a simple set of rules.

When more of the sub-transmission and distribution SCADA data is available for use in a topology estimator or connectivity validation tool, then the "deeper" CA will benefit from using a valid network model, and will be more reliable. An advanced communications architecture will provide this additional data for improved topology. This addresses another of the operational problems that are described in the Interim Report on the August 2003 Blackout.

1.4.2.3 CA with access to alternate and wide area data

The CA algorithm sometimes fails to solve, because of faulty or missing data, or an incorrect network model. Typical problems include:

- Use of manually-entered data (sometimes obtained by phone from a neighboring utility) that is incorrect or incorrectly entered,
- Use of telemetered data that is inaccurate or invalid, or
- Incorrect assumptions about the operating status of equipment (such as transmission lines or generators) at the boundary of a utility's service area.

The improved communications architecture can be used to provide a wider range of data from other utilities, which the Future CA will use to become more robust and accurate. With a wider range of data available, some of it being obtained from alternate sources outside the local operating area, the CA application and user have access to the data that "best fits" the situation under study. The CA user will choose the best data for the situation, and can either select it or manually enter it for use during the set up procedure.

With an advanced communications architecture providing additional and redundant "checkpoint" data to CA, the application can be enhanced to automatically choose the correct data for dependable solutions (see the next section for "intelligent CA").

The availability of alternate and a wider range of data (from the boundary of a utility and from other utilities in the region) will therefore improve the ability of CA to work reliably, to provide solutions in unusual cases.

1.4.2.4 CA using special data (condition monitoring and phase angle measurements)

Although utilities are increasing their use of equipment condition monitoring data for asset management and maintenance planning, this data is rarely used in system operations or security assessment. Future CA will use equipment condition data to:

- Provide condition-based operating limits for major power system equipment (such as transformers, transmission lines, series compensators, and inductors);
- Initiate contingency analysis studies as part of the equipment outage planning and scheduling process;
- Integrate equipment condition data and contingency analysis in the reliability based maintenance process.

With improved transducers and very tight time synchronization (approaching a few milliseconds in current utility tests at Bonneville Power and SRP), transmission line phase angle measurements within utilities and over wide areas are starting to be used to show pending power system stability problems. Future CA will use these phase angle measurements to initiate contingency analysis in its on-line mode, so that operators can see potential problems as they are developing.

When phase angle indicators of potential problems (power angle "twist" approaching stability limits) are combined with the Future CA capabilities, remedial actions will be suggested for operators, or in some cases they will be automatically executed, similar to load and generation shedding schemes.

1.4.2.5 CA with remedial action

Future CA will make use of the advanced communications architecture to become more of a "closed loop" application. In addition to:

- acquiring and using data from wider, deeper, alternate and special sources, and
- providing warnings and alarms for potential problem situations for future contingency events,

it will provide remedial action plans as part of the CA results. Operators will use these to "move" the power system away from exposure to insecure (due to overloads and violations) or unstable conditions, which the contingency analysis shows for possible outages in the system.

SystemOperator can perform these remedial actions, but in some cases they will be executed automatically using the control capabilities of the data acquisition and control (DAC) application. The advanced communications architecture will provide access to the field equipment and control devices; however in most situations remedial actions will be routed through DAC to avoid conflicts.

For wide area and regional operations, remedial actions will need to be coordinated among the participating utilities and reliability organizations. With proper coordination and planning, Future CA can send remedial action control outputs directly to field equipment and automatic systems, similar to the load shedding and generation dumping schemes used currently.

1.4.2.6 Additional "intelligence" features for CA

The Future CA can be enhanced with the ability to "look for the best source" data that will allow it to resolve problem situations. The application can use the communications architecture to interrogate alternate sources and actively find better data from the wider range available, both inside and outside the utility.

Future CA will also be able to check a stored library of previous studies and solutions, to identify similar situations to the current study being performed. This "knowledge base" library will include previous "fixes" applied by specialists for problem cases that did not solve without adjustments.

Future CA will use its knowledge base to assist the user (using prompts or assumptions) with the set up procedures and definition of the input data, network model adjustments, contingency lists and execution parameters.

In case of problems with the network model, or if the input data does not match the model, Future CA can exercise its "intelligence" by:

- finding and suggesting the best data to use from alternate sources, or
- checking its knowledge base and suggesting changes to the model or input data.

These changes or fixes can be quickly tried in a user-prompted or "self-healing" mode, so that CA guides itself toward a solution while alerting the user about the decisions it has made. An audit trail with the decision logic and choices will be maintained as part of the

solution mechanism. As CA gains experience in resolving problem situations, it will be able to provide to users a confidence factor for its solutions. In this way raw data (from alternate sources and about the guided solution process) is transformed into useful information, and becomes part of the knowledge base.

These "intelligent" features of CA - the ability to find better data, and to learn from and use its previous solution experience - will improve its reliability and usability as an on-line operations tool. The intelligence features of Future CA form a significant enhancement to current baseline CA, and make it a key component of the self-healing grid of the future.

1.4.2.7 CA coupled with the SystemOperator Training Simulator

In most current implementations, contingency analysis works separately (and often remotely) from the SystemOperator Training Simulator. When operating situations and contingency analysis cases/solutions are encountered that would be useful as training scenarios for operators, there are often no tools (or cumbersome tools) to transfer these cases to the Training Simulator.

The advanced communications architecture will include the capability for quick and easy transfer of cases from Future CA to SystemOperator Training Simulators. Tools for standardizing the case descriptions, data formats and input requirements will be needed for "feeding" Training Simulator applications from various suppliers.

Future CA will therefore be a source of challenging cases to be used for improved training for operators. This is another step toward the self-healing grid.

1.4.2.8 Future CA – prerequisites and outstanding issues

There are several prerequisites and issues that should be examined in more detail and resolved for the successful implementation of Future CA, considering its wide area capability and other improvements. These include:

- Apply and benefit from the experience with the basic wide area CA as already implemented at ISOs and RTOs in their function as area and regional reliability coordinators;
- Significant work and tools will be needed to develop and support the wide area network model, its frequent changes, and its parameters;
- Methods must be developed to collect the necessary data from many sources (participating utilities and regional authorities), and "feed" a wide area CA, fast enough (collection target within 10 seconds) to support its on-line use by operators;

- Significant work and tools will be needed to acquire and exchange data in common formats, requiring data conversion and re-mapping among different EnergyManagementSystems, data sources and applications;
- Uniform data access methods will be needed for all types of data, for ease of use;
- High performance needs - wide area CA should execute fast enough (solution target every 20 seconds) to be used for on-line operations support as well as for off-line studies;
- Performance may need to be enhanced by using a reduced wide area network model, that still contains enough detail to provide useful information;
- Data coherence and time synchronization needs (time skew) – the wide area data should be time synchronized (target within 5 seconds) so that the network model uses coherent data;
- Time synchronization needs for special data - phase angle measurements across an operating region must be very tightly synchronized (within a few milliseconds) to be useful;
- Data integrity – the CA input data and its attributes (source, quality, time stamp, etc.) must be preserved throughout the process, and (perhaps) afterward for storage
- Older RTU technology, field devices and communications technology currently used by utilities are limitations that will slow down data gathering to the "lowest common denominator" until they are upgraded;
- Several types of data must be gathered and shared among utilities, including the network model and parameters, initial base case set up data, real-time measurements, State Estimator solutions, special data, manually entered data, and the Future CA results including remedial action plans;
- Storage and archiving – the requirements for short-term storage and historical archiving of Future CA cases, including large data files, should be considered within the communications architecture;
- Work will be needed to develop coordinated remedial action plans for the most serious contingencies, for joint execution by utilities in the region;
- It may be possible to implement automatic triggering and automatic execution of remedial actions, similar to load shedding and generation shedding routines that are largely automatic today;
- For technical support and data flow optimization, it may be more feasible for all participating utilities to use a single regional wide area CA running on a central server (i.e. an extension of the current ISO type of CA), with real-time access and displays provided to all utilities for executing individual studies and obtaining CA results;

- For accuracy of its solutions, the Future CA should include in its network model the operations of Special Protection Systems (such as automatic load shedding and generation dumping), as well as the operating status of these systems;
- Future CA could be extended to provide useful results if the power system breaks into islands, for use in system restoration;
- Common training will be needed for users, including use of the operator training simulator for scenarios in the wide area context;
- For effective use by multiple utilities in an operating region, Future CA will require a common and intuitive User Interface, user procedures, and maintenance tools;
- Improved presentation methods (probably using graphics) will be needed to show the wide area CA results, to ensure easier and quicker understanding by all users, especially the busy power system operators;
- There may be some restrictions on sharing of certain data among utilities due to deregulation (e.g. knowledge of planned outages by one utility might provide a "market power" advantage to another utility).

1.4.2.9 Future CA improvements summary

In summary, the combination of the contingency analysis improvements reviewed above will constitute a Future CA that takes advantage of an advanced communications architecture to address many of the current CA shortcomings. Future CA will feature:

- Acquisition and use of data from wider, deeper, alternate and special sources
- Improved reliability and robustness (i.e. solving without problems and the need for expert assistance) due to the use of wide area, deeper and alternate data
- Improved usability (i.e. easier setup) with the uniform access to, and automatic use of, many sources of data
- Improved usability with a standard and intuitive User Interface
- Increased visibility of the interconnected power system, using the wide area data for regional solutions that are more valuable for on-line operations
- Remedial action plans that CA provides to operators, or automatically executes in some situations using DAC or direct control outputs
- Intelligence to learn from experience and guide itself toward correct solutions, for increased reliability in problem situations
- Use of special data such as equipment condition monitoring and phase angle measurements

- Easy transfer of unusual cases to the training simulator for building scenarios

These CA improvements can be implemented using an advanced communications architecture that is being defined by the IECSA project. Future contingency analysis will provide increased value to system operators, as a dependable on-line decision support tool. Actual implementation of the Future CA by suppliers will likely be done in stages, and is achievable by 2010, to form a major component of a self-healing grid.

1.4.3 Future CA usage

Future CA will be used for off-line studies as follows:

- A request to evaluate a power system change or a planned equipment outage initiates the contingency analysis study
- The CA user sets up the study, using input data from wide area and other sources, now available through the advanced communications architecture (and stored for use in "future" study cases)
- The intelligence features of CA assist the user to define the study case, including the input data, network model adjustments, contingency lists, and the execution parameters
- In case of execution problems, the intelligence features help to find a solution using alternate data or model adjustments, based on previous learned experience
- CA presents its wide area results (severity-ranked lists of overloads and violations, for the utility and the operating region) to the CA user for evaluation (probably with graphic displays for easier interpretation of the results)
- If necessary, the CA user easily transfers the study case and parameters to the Training Simulator for use in building operator training scenarios

Future CA will be used for on-line operations support as follows:

- Experts perform the set up of CA for on-line use, including the network model, definition of input data and the contingency list to be used, etc.
- An execution control program in the EMS for the security analysis sequence initiates CA to execute continuously, typically every 20 seconds
- CA uses for its solutions the wide area and other source data for the current operating conditions, continuously updated through the advanced communications architecture

- In case of execution problems, the intelligence features automatically find a solution using alternate data or model adjustments, based on previous learned experience
- CA presents its wide area results (severity-ranked lists of overloads and violations, plus warnings and alarms to notify of potential problems) to the system operators for decision support
- CA also provides lists of remedial actions for each severe contingency, for manual implementation by operators, or for automatic execution using the DAC application and the advanced communications network
- If necessary, the operators can easily transfer interesting CA cases and remedial action lists to the Training Simulator

As shown above, to the casual observer Future CA will work in a similar way to current baseline CA. However with its improvements the application will be more reliable, the results will show the wide area effects of contingencies, and operators will have an on-line tool that assists with remedial actions.

1.4.4 Future CA incremental data inputs and outputs

In addition to the data inputs that already are used in current baseline contingency analysis, Future CA will exploit the advanced communications architecture to use the following "new" data:

- Wide area data such as SCADA, network models and parameters, State Estimator solutions, telemetry and manual entries obtained from a large operating region, beyond each utility's boundaries
- Deeper data and accurate topology information from SCADA, distribution systems, telemetry and manual entries within each utility
- Alternate and substitute data, that Future CA actively seeks for use in solving execution problem situations
- Special data such as equipment condition monitoring and phase angle measurements

In addition to the results that already are provided by current baseline contingency analysis, Future CA will use its improvements and exploit the advanced communications architecture to provide the following "new" outputs:

- Remedial action lists, for operators to implement, or for automatic execution
- Control outputs (remedial action commands) to the DAC application, or in some cases directly to field devices and special protection systems

- Storage of cases and model or data adjustments by experts, for use in the knowledge base library
- Transfer of cases and associated parameters to the SystemOperator Training Simulator

These incremental inputs and outputs will be supported by the advanced communications architecture, to enhance the Future contingency analysis application.

1.4.5 Additional communications impacts for "central server" CA

If Future CA were implemented in a central server, to serve many remote users at utilities throughout an operating region, there would be communications impacts due to:

- Users sending requests and data for off-line contingency analysis studies to be executed at the central CA facility
- The return of CA results and displays to regional users
- The continuous "broadcast" of on-line CA results to operators and other users at participating utilities

In this use case template, it is assumed that each participating utility will have its own Future CA application working in its EnergyManagementSystem. The analysis and communications impacts reflect this "individual Future CA" model.

1.5 Actor (Stakeholder) Roles

Describe all the people (their job), systems, databases, organizations, and devices involved in or affected by the Function (e.g. operators, system administrators, technicians, end users, service personnel, executives, SCADA system, real-time database, RTO, RTU, IED, power system). Typically, these actors are logically grouped by organization or functional boundaries or just for collaboration purpose of this use case. We need to identify these groupings and their relevant roles and understand the constituency. The same actor could play different roles in different Functions, but only one role in one Function. If the same actor (e.g. the same person) does play multiple roles in one Function, list these different actor-roles as separate rows.

<i>Grouping (Community)</i>		<i>Group Description</i>
<p><i>Users of Future Contingency Analysis (CA) for off-line power system security studies, and related actors.</i></p> <p><i>Note that "security" means the safe (equipment will not be damaged) and stable (the power system will remain up and running) operation of the electric power system.</i></p>		<p><i>Users of Future Contingency Analysis in an off-line (non real-time) "study" mode or environment for (a) power system planning (changes or expansion), or for (b) equipment outage planning and scheduling.</i></p>
<i>Actor Name</i>	<i>Actor Type (person, device, system etc.)</i>	<i>Actor Description</i>
SystemPlanner	Person	Prime actor and off-line CA user. Engineer who studies the power system to ensure overall system security, with the ability to withstand at least the first major contingency (failure event). Assists with planning and evaluating changes to the power system, such as the addition of substations and transmission lines.
EquipmentOutagePlanner and Scheduler	Person	Prime actor and off-line CA user. Engineer who responds to outage requests from field maintenance personnel ("can I take this equipment out of service from XX to YY date?" by evaluating the impact on power system security if the equipment is withdrawn. Schedules equipment outages for minimum risk (to avoid same-time outages of key equipment), approves outage requests for execution by operators, and assists with the preparation of the annual maintenance schedule for the complete power system.
Future CA User (SM)	Person	Generic "stand-in" user actor for the SM = study mode, representing either of the main off-line CA users – the power system planner or the equipment outage planner/Scheduler. For simplicity, this generic actor is used in the sequence steps for the Future CA off-line study mode.
EnergyManagementSystem	Computer system (single machine or distributed)	The computer system that supports computation through various applications (including Contingency Analysis), the user interface

<i>Grouping (Community)</i>		<i>Group Description</i>
<p><i>Users of Future Contingency Analysis (CA) for off-line power system security studies, and related actors.</i></p> <p><i>Note that "security" means the safe (equipment will not be damaged) and stable (the power system will remain up and running) operation of the electric power system.</i></p>		<p><i>Users of Future Contingency Analysis in an off-line (non real-time) "study" mode or environment for (a) power system planning (changes or expansion), or for (b) equipment outage planning and scheduling.</i></p>
<i>Actor Name</i>	<i>Actor Type (person, device, system etc.)</i>	<i>Actor Description</i>
	network based)	<p>(displays), data input and output, communications (internal and external), storage in its databases, and other functions.</p> <p>The EnergyManagementSystem is an actor in the sense that it is responsible for the control and execution of these many functions, including CA.</p>
EMSDatabase	Stored information in computer memory or on media	<p>Main repository of the real-time and static information used by Contingency Analysis and its human actors, and by other EMS applications. Responsible for:</p> <ul style="list-style-type: none"> • finding, organizing, storing and providing the data requested by CA and other applications, and needed by the user displays, and • storage of CA results. <p>The EMS databases provide the power system data (collected by the DAC application) including real-time information, wide area and other input data used by Future CA, and the State Estimator solutions for initializing CA studies that are based on the current operating conditions.</p>
Future Contingency Analysis application	Computer program(s) and displays	<p>The solution engine within the Future CA application that solves the network model for each contingency event, and calculates the CA results.</p> <p>Includes Future CA internal application improvements such as</p>

<i>Grouping (Community)'</i>		<i>Group Description</i>
<p><i>Users of Future Contingency Analysis (CA) for off-line power system security studies, and related actors.</i></p> <p><i>Note that "security" means the safe (equipment will not be damaged) and stable (the power system will remain up and running) operation of the electric power system.</i></p>		<p><i>Users of Future Contingency Analysis in an off-line (non real-time) "study" mode or environment for (a) power system planning (changes or expansion), or for (b) equipment outage planning and scheduling.</i></p>
<i>Actor Name</i>	<i>Actor Type (person, device, system etc.)</i>	<i>Actor Description</i>
		<p>intelligence, knowledge base, use of wide area & alternate & special data, output of remedial actions, etc. For simplicity these functional improvements will not be modeled with separate actors, although some improvements will have associated communications requirements that are significant.</p> <p>Also includes user interface (UI) displays provided by the EMS and the CA application for data input and information output.</p>
SystemPlanner	Person(s)	<p>Note: This description is included for background information only; this secondary actor does not need to be "modeled".</p> <p>Engineers and technicians who are responsible for power system planning. They provide change study requests to the power system planner (a CA user) in the form of planned modifications to the electric power system, using drawings and written specifications.</p>
FieldEquipmentMaintenanceMgmtSystem	Person(s)	<p>Note: This description is included for background information only; this secondary actor does not need to be "modeled".</p> <p>Engineers and technicians who are responsible for power equipment maintenance (for generators, power lines, transformers, etc.) and preparation of the annual maintenance and outage plan. They request outage approvals from the outage planner and Scheduler (a CA user), in order to withdraw equipment from</p>

<i>Grouping (Community)'</i>		<i>Group Description</i>
<p><i>Users of Future Contingency Analysis (CA) for off-line power system security studies, and related actors.</i></p> <p><i>Note that "security" means the safe (equipment will not be damaged) and stable (the power system will remain up and running) operation of the electric power system.</i></p>		<p><i>Users of Future Contingency Analysis in an off-line (non real-time) "study" mode or environment for (a) power system planning (changes or expansion), or for (b) equipment outage planning and scheduling.</i></p>
<i>Actor Name</i>	<i>Actor Type (person, device, system etc.)</i>	<i>Actor Description</i>
		service for maintenance.
PowerNetworkModelEngineer	Person	<p>Note: This description is included for background information only; this secondary actor does not need to be "modeled".</p> <p>NetworkEngineer specialist, who maintains the model of the power system (used by CA and other control center applications) to keep it current, and consistent with the utility's and the neighboring utilities' configurations.</p>
DatabaseAdministrator	Person(s)	<p>Note: This description is included for background information only; this secondary actor does not need to be "modeled".</p> <p>Database analyst who performs changes to, and resolves problems with, the various databases in the EMS that CA uses.</p>
ExternalComputerSystem	Devices	<p>Sources of utility, wide area and other data used by Future CA for its solutions. These include:</p> <ul style="list-style-type: none"> • other computer systems within the utility (e.g. power equipment parameters are stored in a different computer system), and • computer systems and other data sources at other power utilities which provide necessary data about neighboring power systems, using data links and other communications methods. <p>Note: for modeling purposes, these external systems could be</p>

<i>Grouping (Community)'</i>		<i>Group Description</i>
<p><i>Users of Future Contingency Analysis (CA) for off-line power system security studies, and related actors.</i></p> <p><i>Note that "security" means the safe (equipment will not be damaged) and stable (the power system will remain up and running) operation of the electric power system.</i></p>		<p><i>Users of Future Contingency Analysis in an off-line (non real-time) "study" mode or environment for (a) power system planning (changes or expansion), or for (b) equipment outage planning and scheduling.</i></p>
<i>Actor Name</i>	<i>Actor Type (person, device, system etc.)</i>	<i>Actor Description</i>
		<p>divided into "local" and "wide area remote" sources of data. The communications requirements for each source will be specific to that source.</p> <p>Practically all external data is provided through the EMS databases. Therefore the model will be simplified by using a single actor (external computer systems) as the source for all "other data" used by CA.</p>
Special systems	Devices	<p>Sources of special data used by Future CA for its solutions. Includes equipment condition monitoring data and phase angle measurements from the utility and the wider operating region.</p> <p>This actor can be shown in the model simply to highlight a different data source used by Future CA. However this data would still route through the EMSDatabase actor.</p>
DAC	Subsystem and application in the EMS or SCADA system	<p>Collects most of the real-time and wide area data for the EMS databases.</p> <p>Also, for on-line CA, DAC is the receiver and processor of control commands to field devices in the power system.</p> <p>(a) Operators can use DAC to perform remedial actions as suggested by Future CA results (i.e open breakers, increase</p>

<i>Grouping (Community)'</i>		<i>Group Description</i>
<p><i>Users of Future Contingency Analysis (CA) for off-line power system security studies, and related actors.</i></p> <p><i>Note that "security" means the safe (equipment will not be damaged) and stable (the power system will remain up and running) operation of the electric power system.</i></p>		<p><i>Users of Future Contingency Analysis in an off-line (non real-time) "study" mode or environment for (a) power system planning (changes or expansion), or for (b) equipment outage planning and scheduling.</i></p>
<i>Actor Name</i>	<i>Actor Type (person, device, system etc.)</i>	<i>Actor Description</i>
		<p>generation, etc.),</p> <p>or in some cases</p> <p>(b) Future CA may send commands directly to DAC to perform remedial actions as automatic procedures, without operator assistance.</p>
SystemPlanners		
SystemOperator		
NERC		

Replicate this table for each logic group.

<i>Grouping (Community)</i>		<i>Group Description</i>
<p><i>Users of Future Contingency Analysis (CA) for on-line power system security studies and operations decision support, with related actors.</i></p> <p><i>Note that "security" means the safe (equipment will not be damaged) and stable (the power system will remain up and running) operation of the electric power system.</i></p>		<p><i>Users of Contingency Analysis in an on-line (essentially real-time) environment, to support power system operations. Typically they use the Energy Management System in the control room. Group includes related actors for these users.</i></p> <p><i>Note - only the ADDITIONAL actors for on-line Future CA use are identified here. The other actors are the same as for the Grouping for off-line study use.</i></p>
<i>Actor Name</i>	<i>Actor Type (person, device, system etc.)</i>	<i>Actor Description</i>
SystemOperator	Person	<p>Primary user of on-line CA. Also called a "Dispatcher". Person who "operates" the power system using the DAC (data acquisition and control) application in the EMS and/or SCADA system, to manage the operating conditions of the power system in real-time.</p> <p>In a wide area context there will be several operators at the utilities in an operating region, all using Future CA and its results including remedial action suggestions.</p>
OutageCoordinator	Person	<p>User of on-line CA. The outage coordinator manages the short-term weekly and daily equipment outage schedule, approves each scheduled outage before it is implemented by operators, and advises operators during the equipment withdrawal procedures.</p>
NetworkEngineer	Person	<p>User of on-line CA. The network engineer is an expert in the power system who advises operators (usually upon request) before and during their execution of complex or unusual procedures. He also monitors the current operating conditions and the CA results.</p>
Future CA User (OM)	Person	<p>Generic "stand-in" user actor for the OM = on-line mode, representing any of the main on-line Future CA users – the operator, outage coordinator, or network engineer.</p>

<i>Grouping (Community)</i>		<i>Group Description</i>
<p><i>Users of Future Contingency Analysis (CA) for on-line power system security studies and operations decision support, with related actors.</i></p> <p><i>Note that "security" means the safe (equipment will not be damaged) and stable (the power system will remain up and running) operation of the electric power system.</i></p>		<p><i>Users of Contingency Analysis in an on-line (essentially real-time) environment, to support power system operations. Typically they use the Energy Management System in the control room. Group includes related actors for these users.</i></p> <p><i>Note - only the ADDITIONAL actors for on-line Future CA use are identified here. The other actors are the same as for the Grouping for off-line study use.</i></p>
<i>Actor Name</i>	<i>Actor Type (person, device, system etc.)</i>	<i>Actor Description</i>
		For simplicity, this generic actor is used in the sequence steps for the Future CA on-line mode.

1.6 Information exchanged

Describe any information exchanged in this template.

<i>Information Object Name</i>	<i>Information Object Description</i>
Outage request	<p>Document form, electronic and paper</p> <p>The outage request is a form submitted by field maintenance personnel to the equipment outage planner and Scheduler. It requests approval to take equipment out of service for a defined period of time, for a specific reason.</p>
Outage approval	<p>Document form, electronic and paper</p> <p>Approval form issued by the outage planner and Scheduler, to approve the equipment outage and schedule it for a specified date/time/duration. Operations and maintenance personnel would then perform the equipment outage procedures.</p>

<i>Information Object Name</i>	<i>Information Object Description</i>
Change study request (study of a power system modification)	Document drawing and description, electronic and paper Notice of a planned change to the power system (e.g. the addition of a substation) to be studied. The system planner reviews this change using CA, to evaluate the impacts on the modified configuration in case of contingency events (equipment failures).
Change study report	Document drawing and description, electronic and paper Report prepared by the system planner from the results of the CA study, which accepts, accepts with modifications, or requests further study about the planned change.
Annual maintenance and outage plan (or similar names)	Document, electronic and paper Plan used to schedule the un-availabilities for power system equipment. Consulted to determine future planned configurations of the power system. Used for studies of new outage requests and for risk assessment by operations. Is refined into monthly and weekly outage schedules throughout the year, to reflect current operating conditions of the power system.
Network model (wide area)	Stored files on computer media Static simulated model of the wide area power system, used by Future CA. This model uses the parameters and characteristics of the real-world power system and "behaves" like the real system for the purposes of studies. Can be a model of the current power system, or of a future configuration of the power system.
Base case initial data	Stored files on computer media + Manually entered data Data that CA obtains from the EMS databases in order to set up the network model before executing the analysis. Includes data that is entered manually by users. Sometimes the base case is for a study of a future operating condition of the power system, requiring a future "picture" of the network and its parameters. Future CA will assist the definition of the base case initial data, with automated choices based on previous similar situations, and "prompts" to the user.
CA study model	Temporary or stored file

<i>Information Object Name</i>	<i>Information Object Description</i>
	<p>Network model that has been adjusted by the CA user, by removing or adding equipment until it represents the desired starting point for the CA study.</p> <p>Future CA will assist the definition of the study model, with automated choices based on previous similar situations, and "prompts" to the user.</p>
Contingency list	<p>Document, electronic and paper and Temporary or stored file</p> <p>List of contingency events (equipment outages) that is prepared by the CA user, and input to CA as the list of events to evaluate. Typically a base contingency list is retrieved from the EMS database and manually enabled and modified by the user (on displays) before it is ready for CA to use.</p> <p>These lists can range from a few selected items of power system equipment, to thousands of elements of the power system. They are the "test scripts" for CA execution.</p> <p>Future CA will assist the definition of the contingency list, with automated choices based on previous similar situations, and "prompts" to the user.</p>
Execution parameters	<p>Stored files on computer media + Manually entered data</p> <p>Control parameters (enable or disable certain features of the application, and enter values) that the CA user selects from menus or enters manually, to set up the behavior and functionality of the application.</p>
Screened contingency list	<p>Document, electronic and paper and Temporary or stored file</p> <p>List of the most serious equipment outages that are selected by the CA screening process (or manually selected by the CA user) to undergo a complete analysis to determine the severity of violations and overloads.</p>
CA results	<p>Document forms and graphic pictures, electronic and paper</p> <p>Lists of bus voltage violations and branch overloads for the wide area operating region, shown in displays and on printouts. Typically these results consist of long lists of numbers sorted by priority – worst case violations/overloads are shown at the top of the list. Future CA will have improved visualization technology and incorporate graphic pictures for easier interpretation of results.</p> <p>CA users also provide written reports to summarize these results for other departments.</p>

<i>Information Object Name</i>	<i>Information Object Description</i>
Stored CA results	Data files CA study results are stored in the EMS databases for review by system planning, outage scheduling, and operations personnel. They can also be accessed by or transferred to the Training Simulator, for use in building training scenarios for operations personnel.
CA error messages	Temporary or stored file The CA application issues notification to the users of any problems with its execution, so that the user can adjust the model or provide additional data inputs to correct the problem. Future CA will use its intelligence features to resolve solution problems based on previous experience and the use of better or alternate data.
CA warnings and alarms	Temporary or stored file For on-line users Future CA will issue warning messages and even audible alarms, to notify operators about overloads or violations that WOULD occur IF certain contingency events happen in future. These are essentially "preview" warnings or alarms about the effects of possible future events.
Remedial action suggestions	Temporary or stored file Future CA will provide suggestions for operators to correct potential overloads and violations. These would typically consist of suggestions to adjust or add generation, reduce load, adjust power system voltage levels, add reactive VAR resources, isolate a problem area, etc.
Remedial action commands	Temporary or stored files Future CA may send commands directly to DAC to perform remedial actions as automatic procedures, without operator assistance. Operators will also issue remedial action commands to DAC.
Saved cases for the knowledge base library	Data files Future CA will save useful and unusual study cases (network models, base case data, and adjustments by experts to allow solutions) in its knowledge library. The intelligence features will use this library

<i>Information Object Name</i>	<i>Information Object Description</i>
	to assist in providing solutions when execution problems occur.
Saved cases for the SystemOperator Training Simulator	Data files Future CA will transfer interesting study cases (network models, base case data and results) to the SystemOperator Training Simulator using easy procedures, if a CA user initiates this type of "saved case".

1.7 Activities/Services

Describe or list the activities and services involved in this Function (in the context of this Function). An activity or service can be provided by a computer system, a set of applications, or manual procedures. These activities/services should be described at an appropriate level, with the understanding that sub-activities and services should be described if they are important for operational issues, automation needs, and implementation reasons. Other sub-activities/services could be left for later analysis.

<i>Activity/Service Name</i>	<i>Activities/Services Provided</i>
Acquire and use extensive data	Future contingency analysis (CA) will use extensive data to be more robust, and to provide wide area analysis and visibility of the regional power system.
Use intelligent features to solve execution problems	Future CA will incorporate intelligent features to solve difficult cases, with minimal assistance needed from users and experts.
Identify the most serious contingencies for detailed analysis	CA performs a quick screening of the hundreds or even thousands of possible equipment outages (contingencies), and identifies the few (typically 10-50) that would have the worst effects on the power system.
Analyze the most serious contingencies and quantify the effects of each	CA performs a complete analysis of the most serious contingencies, to calculate the magnitude of branch overloads and voltage violations for individual elements of the power system. These "what if" simulations are the main tool for ensuring secure power system operation in case of equipment failures or planned equipment outages.
Organize the analysis results (by severity) and display them to users	CA presents the overloads and violations in order of their severity, in tabular lists. These are displayed

<i>Activity/Service Name</i>	<i>Activities/Services Provided</i>
(both on-line and off-line use)	and can be stored for reference. Future CA will use graphic displays for presentation of wide area results. For on-line use by operators, summary displays show highlights of the CA results, such as the names of contingency events that would result in severe overloads, and the number of these overloads.
Issue warnings and alarms to operators (on-line use)	CA issues warning and alarm messages to power system operators, to alert them about the effects of future contingency events (i.e. a preview) that would result in branch overloads and voltage violations.
Provide remedial actions (on-line use)	Future CA will provide remedial action suggestions for operators to perform, and will issue remedial action commands for automatic execution.
Save results and cases for reference, in the CA database and knowledge base	CA users can save results and the study cases (power system conditions), for future review. This includes Future CA saving in its knowledge base difficult cases and fixes applied by experts, for intelligent use in future situations. Note: this "save case to knowledge base" activity is NOT included in the step-by-step analysis, because it is an internal (background) activity of Future CA, with no external communications impact.
Transfer study cases to the operator training simulator for use in training	Future CA users can easily transfer interesting study cases to the operator training simulator, for use in training scenarios.

1.8 Contracts/Regulations

Identify any overall (human-initiated) contracts, regulations, policies, financial considerations, engineering constraints, pollution constraints, and other environmental quality issues that affect the design and requirements of the Function.

<i>Contract/Regulation</i>	<i>Impact of Contract/Regulation on Function</i>
Deregulation and competition (FERC Orders 888 and 889, etc.)	May restrict the sharing of power system data (especially equipment unavailabilities) among competing utilities (and related companies), which could limit the Contingency Analysis solutions to the "observable" network, instead of a wider area solution.

<i>Policy</i>	<i>From Actor</i>	<i>May</i>	<i>Shall Not</i>	<i>Shall</i>	<i>Description (verb)</i>	<i>To Actor</i>
NERC Operating Policy 2.A – Transmission Operations	NERC			X	Operate the power system in a secure and reliable manner, using security analysis tools to recognize and avoid problem conditions. "All control areas shall operate so that instability, uncontrolled separation, or cascading outages will not occur as a result of the most severe single contingency." (voluntary reliability guidelines and standards for utilities)	SystemPlanners and SystemOperator

<i>Constraint</i>	<i>Type</i>	<i>Description</i>	<i>Applies to</i>
Thermal limits of power system equipment	Engineering	Flow limits (maximum current and MW) to be respected in order to avoid damage to, or premature aging of, power system equipment (such as generators, transmission lines, transformers, breakers, etc.). Used by CA to calculate overloads.	Future Contingency Analysis application
Stability limits for transmission lines and corridors	Engineering	Flow limits (maximum MW and MVA) for transmission lines and corridors, to be respected in order to maintain power system stability. Used by CA to calculate overloads.	Future Contingency Analysis application
Voltage limits	Engineering	Voltage limits on buses (high and low) to be respected in order to maintain secure and stable operation of the power system. Used by CA to calculate violations.	Future Contingency Analysis application

Wide area and other data	Communications	Future CA will need an advanced communications architecture to provide wide area and other types of data for the calculations.	DAC
Need for fast solutions (a)	Performance of the application (computer resources)	For on-line use by power system operators (decision support), CA must provide fast solutions, within seconds of an event. Current (2004) computer resources can already meet this constraint, so there is no problem for Future CA resources.	EnergyManagementSystem
Need for fast solutions (b)	Performance of the application (application design)	For on-line use by power system operators (decision support), CA must provide fast solutions, within seconds of an event. Future CA will have improvements to meet this constraint, even for wide area solutions.	Future Contingency Analysis application
Need for robust application	Reliability of the application (application design and features)	For both off-line and on-line use, CA must be reliable – it must provide solutions even in difficult situations with limited input data. Future CA will have intelligent features to assist with solutions.	Future Contingency Analysis application
Need for ease-of-use of the application	Usability of the application (application design and user interface)	In order to be useful for on-line analysis and decision support, the CA application must be easy to use, without requiring a programmer's skills.	Future Contingency Analysis application
Need for fast analysis of the results	Usability of the application (application design and results presentation)	The CA application must present its voluminous numeric results in a manner that can be quickly understood by users, especially for on-line use. This requires summary displays and graphical displays that are designed for easier interpretation.	Future Contingency Analysis application

2 Step by Step Analysis of Function

Describe steps that implement the function. If there is more than one set of steps that are relevant, make a copy of the following section grouping (Preconditions and Assumptions, Steps normal sequence, and Steps alternate or exceptional sequence, Post conditions)

2.1 Steps to implement function

Name of this sequence.

Future Contingency Analysis Off-line Study Mode Sequence (SM)

2.1.1 Preconditions and Assumptions

Describe conditions that must exist prior to the initiation of the Function, such as prior state of the actors and activities

Identify any assumptions, such as what systems already exist, what contractual relations exist, and what configurations of systems are probably in place

Identify any initial states of information exchanged in the steps in the next section. For example, if a purchase order is exchanged in an activity, its precondition to the activity might be 'filled in but unapproved'.

<i>Actor/System/Information/Contract</i>	<i>Preconditions or Assumptions</i>
EMSDatabase	The EMS databases must contain current power system data for the wide area operating region and other data needed by Future CA, including the State Estimator solutions for initial data.
Network model	The network model must reflect the current or other situation of the regional power system that will be studied.

2.1.2 Future Contingency Analysis Off-line Study Mode Sequence = FCA-SM steps

Describe the normal sequence of events, focusing on steps that identify new types of information or new information exchanges or new interface issues to address. Should the sequence require detailed steps that are also used by other functions, consider creating a new “sub” function, then referring to that “subroutine” in this function. Remember that the focus should be less on the algorithms of the applications and more on the interactions and information flows between “entities”, e.g. people, systems, applications, data bases, etc. There should be a direct link between the narrative and these steps.

The numbering of the sequence steps conveys the order and concurrency and iteration of the steps occur. Using a Dewey Decimal scheme, each level of nested procedure call is separated by a dot ‘.’. Within a level, the sequence number comprises an optional letter and an integer number. The letter specifies a concurrent sequence within the next higher level; all letter sequences are concurrent with other letter sequences. The number specifies the sequencing of messages in a given letter sequence. The absence of a letter is treated as a default ‘main sequence’ in parallel with the lettered sequences.

Sequence 1:

*1.1 - Do step 1
1.2A.1 - In parallel to activity 2 B do step 1
1.2A.2 - In parallel to activity 2 B do step 2
1.2B.1 - In parallel to activity 2 A do step 1
1.2B.2 - In parallel to activity 2 A do step 2
1.3 - Do step 3
1.3.1 - nested step 3.1
1.3.2 - nested step 3.2*

Sequence 2:

*2.1 - Do step 1
2.2 - Do step 2*

#	Event	Primary Actor	Name of Process/Activity	Description of Process/Activity	Information Producer	Information Receiver	Name of Info Exchanged	Additional Notes	IECSA Environments
#	<i>Triggering event? Identify the name of the event.¹</i>	<i>What other actors are primarily responsible for the Process/Activity? Actors are defined in section 1.5.</i>	<i>Label that would appear in a process diagram. Use action verbs when naming activity.</i>	<i>Describe the actions that take place in active and present tense. The step should be a descriptive noun/verb phrase that portrays an outline summary of the step. "If ...Then...Else" scenarios can be captured as multiple Actions or as separate steps.</i>	<i>What other actors are primarily responsible for Producing the information? Actors are defined in section 1.5.</i>	<i>What other actors are primarily responsible for Receiving the information? Actors are defined in section 1.5. (Note – May leave blank if same as Primary Actor)</i>	<i>Name of the information object. Information objects are defined in section 1.6</i>	<i>Elaborate architectural issues using attached spreadsheet. Use this column to elaborate details that aren't captured in the spreadsheet.</i>	<i>Reference the applicable IECSA Environment containing this data exchange. Only one environment per step.</i>
1.1	Outage request Or Change study request (can split these later into separate sequences if necessary, but each request initiates the same steps)	FieldEquipmentMaintenanceMgmt System Or SystemPlanner	Initiate CA study	Initiates the Contingency Analysis study, by: <ul style="list-style-type: none"> a request for off-line analysis of an equipment outage request or a change (to the power system) request 		Future CA User (SM) (a generic user to represent the EquipmentOutagePlanner and Scheduler, or the SystemPlanner)	Outage request Or Change study request		Intra-Control Center

¹ Note – A triggering event is not necessary if the completion of the prior step – leads to the transition of the following step.

#	Event	Primary Actor	Name of Process/Activity	Description of Process/Activity	Information Producer	Information Receiver	Name of Info Exchanged	Additional Notes	IECSA Environments
1.2		Future CA User (SM)	Set up CA study	<p>CA user sets up the CA study, by using CA displays to feed/input/acquire the necessary network model and data from the EMS databases, and by using manual entries.</p> <p>Notes:</p> <ul style="list-style-type: none"> • the intelligent features of Future CA will prompt and assist the set up procedures; • several elements of data are required to "set up" a CA study; • these elements can be acquired from many wide area and other sources, however all necessary data is available through the EMS databases; • this process becomes more complex for a future study case 	<p>EMS databases ExternalComputerSystem Special systems DAC</p>	Future Contingency Analysis application	<p>Network model Base case initial data</p>	Communications issues: interfaces and data exchange and performance	Intra-Control Center

#	Event	Primary Actor	Name of Process/Activity	Description of Process/Activity	Information Producer	Information Receiver	Name of Info Exchanged	Additional Notes	IECSA Environments
1.3		Future CA User (SM)	Adjust the network model	CA user adjusts the network model to represent the power system configuration to be studied. The user performs this by manually removing equipment from a base configuration, or possibly by adding equipment.		Future ContingencyAnalysis application	CA study model	Communications issues: may need access to stored future data and historical data	Intra-Control Center
1.4		Future CA User (SM)	Define contingency list to be used	CA user defines the list of contingency events to be used in the study. Includes making manual adjustments to stored lists retrieved from the EMS database. This list could range from a few outages to be evaluated, to thousands of outages to be simulated.	EMS databases	Future ContingencyAnalysis application	Contingency list		Intra-Control Center
1.5		Future CA User (SM)	Set CA execution parameters	CA user sets the CA execution control parameters, to define constraints and outputs.		Future ContingencyAnalysis application	Execution parameters		Intra-Control Center

#	Event	Primary Actor	Name of Process/Activity	Description of Process/Activity	Information Producer	Information Receiver	Name of Info Exchanged	Additional Notes	IECSA Environments
1.6	CA user starts contingency screening process ("start" button)	Future Contingency Analysis application	Screen for worst contingencies	CA application performs a quick check to screen (identify) the worst contingencies, and displays these to the user. Note: users may choose to skip this step and instruct the application to proceed directly to the "complete analysis" step CA-SM.7.		Future CA User (SM)	Screened contingency list		Intra-Control Center
1.6.1	CA solution fails or has solution problems	Future Contingency Analysis application	Future CA resolves solution problems	Future CA alerts the CA user when it encounters solution problems; then will use its intelligent features and ability to find better or alternate data, to automatically resolve problems of incorrect models or mismatched data	Future Contingency Analysis application	Future CA User (SM)	CA error messages	Communications issues: interfaces and data exchange and performance	Intra-Control Center
1.7	CA user starts complete analysis for the worst contingencies	Future Contingency Analysis application	Perform complete analysis of the worst contingencies	Future CA application performs a complete analysis of the worst contingencies, to calculate and display the branch overloads and voltage violations for each outage, for the wide area operating region.		Future CA User (SM)	CA results	Performance and visualization issues	Intra-Control Center

#	Event	Primary Actor	Name of Process/Activity	Description of Process/Activity	Information Producer	Information Receiver	Name of Info Exchanged	Additional Notes	IECSA Environments
1.8		Future CA User (SM)	Reviews and interprets CA results	CA user reviews and interprets the CA results. Typically results are presented in summary tabular displays, however Future CA will use graphic display techniques to assist interpretation of voluminous results.				Presentation and visualization issues	Intra-Control Center
1.9		Future CA User (SM)	Saves results	CA user initiates the printing and "save" of CA results in the EMS databases. User may transfer the CA study model and results to the Training Simulator (an external system).		EMS databases ExternalComputerSystem	CA results	Communications issues: interfaces and data exchange	Intra-Control Center
1.10		Future CA User (SM)	Issues report	CA user issues report based on the CA results: an outage approval, or a report on the effects of the proposed change to the power system. Report templates and forms are typically available from the CA application and EMS. May also affect the annual maintenance and outage plan.		FieldEquipmentMaintenanceMgmtSystem Or SystemPlanner	Outage approval Change study report		Intra-Control Center

2.1.3 Steps – Alternative / Exception Sequences

Describe any alternative or exception sequences that may be required that deviate from the normal course of activities. Note instructions are found in previous table.

#	Event	Primary Actor	Name of Process/Activity	Description of Process/Activity	Information Producer	Information Receiver	Name of Info Exchanged	Additional Notes	IECSA Environments

2.1.4 Post-conditions and Significant Results

Describe conditions that must exist at the conclusion of the Function. Identify significant items similar to that in the preconditions section.

Describe any significant results from the Function

<i>Actor/Activity</i>	<i>Post-conditions Description and Results</i>
	See FCA-SM. 10 above – immediate results of off-line Future CA are in the form of an outage approval, or a study report on the proposed change to a power system configuration.
	Overall result of contingency analysis: a secure and stable power system, even after contingency events occur.

START A SECOND SEQUENCE:

2.1.5 Steps to implement function

Name of this sequence.

Future Contingency Analysis On-line Operations Mode Sequence (OM)

Note: This mode of use of Future Contingency Analysis is very similar to the off-line study mode, except that:

- the users are the power system operators in the control center, outage coordinators who manage the planned withdrawal of equipment from the power system, and network engineers who provide advisory support to the operators
- the application runs continuously in the background, providing its results (a preview of contingency effects) to operators with updates at every execution cycle (target every 20 seconds)
- the application looks at contingencies starting with the current operating situation (not future situations), and uses the current power system data and State Estimator data from the wide area to initiate its network model for the operating region
- operators typically do not interact with the application or initiate their own studies; it is more of a "look only" advisory tool
- the on-line Future CA provides visual warnings and even audible alarms to operators, to notify them of overloads and violations that would occur if certain contingency events happen in future (i.e. a "what if" preview of the effects of future outages)
- on-line Future CA provides lists of remedial action suggestions, which will be performed by operators to correct potential problems
- on-line Future CA may send commands directly to DAC to perform remedial actions as automatic procedures, without operator assistance

2.1.6 Preconditions and Assumptions

Same as 2.1.1 above.

2.1.7 Future Contingency Analysis On-line Operations Mode Sequence = FCA-OM steps

#	Event	Primary Actor	Name of Process/Activity	Description of Process/Activity	Information Producer	Information Receiver	Name of Info Exchanged	Additional Notes	IECSA Environments
#	Triggering event? Identify the name of the event. ²	What other actors are primarily responsible for the Process/Activity? Actors are defined in section 1.5.	Label that would appear in a process diagram. Use action verbs when naming activity.	Describe the actions that take place in active and present tense. The step should be a descriptive noun/verb phrase that portrays an outline summary of the step. "If...Then...Else" scenarios can be captured as multiple Actions or as separate steps.	What other actors are primarily responsible for Producing the information? Actors are defined in section 1.5.	What other actors are primarily responsible for Receiving the information? Actors are defined in section 1.5. <i>(Note – May leave blank if same as Primary Actor)</i>	Name of the information object. Information objects are defined in section 1.6	Elaborate architectural issues using attached spreadsheet. Use this column to elaborate details that aren't captured in the spreadsheet.	Reference the applicable IECSA Environment containing this data exchange. Only one environment per step.
2.1	Periodic "start CA" command from the execution control program	EnergyManagementSystem	Initiate on-line Future CA execution	Initiates the Future Contingency Analysis in periodic cycles (target every 20 seconds) using the application execution control program (security analysis sequence).				Communications issues: gather wide area and other data fast enough to support on-line use of Future CA	Intra-Control Center
2.2	CA results presented to users	Future Contingency Analysis application	Present on-line Future CA results	Presents the on-line Future CA results in displays for the users to consult and monitor; revised results are presented after every CA execution cycle, target every 20 seconds		Future CA User (OM)	CA results CA warnings and alarms Remedial action suggestions	Presentation and visualization issues	Intra-Control Center

² Note – A triggering event is not necessary if the completion of the prior step – leads to the transition of the following step.

#	Event	Primary Actor	Name of Process/Activity	Description of Process/Activity	Information Producer	Information Receiver	Name of Info Exchanged	Additional Notes	IECSA Environments
2.3	Future CA user action	Future CA User (OM)	Action by users of on-line CA	<p>Future CA on-line users may react to the CA results and remedial action suggestions by:</p> <ul style="list-style-type: none"> • SystemOperator: Planning remedial actions, to be ready if a contingency event occurs • OutageCoordinator and NetworkEngineer: Implementing or postponing a scheduled outage • SystemOperator: Making remedial action changes to the power system to reduce exposure to problems in case of a contingency event 		DAC FieldEquipmentMaintenanceMgmtSystem	Remedial action commands	Communications issues: output commands to DAC and field devices	Intra-Control Center
2.4	Future CA action	Future ContingencyAnalysis application	Future CA direct remedial action	Future CA may issue direct remedial action commands to DAC, to correct undesirable operating situations in the power system.		DAC	Remedial action commands	Communications issues: output commands to DAC and field devices	High security DAC

2.1.8 Steps – Alternative / Exception Sequences

N/A

2.1.9 Post-conditions and Significant Results

Describe conditions that must exist at the conclusion of the Function. Identify significant items similar to that in the preconditions section.

Describe any significant results from the Function

<i>Actor/Activity</i>	<i>Post-conditions Description and Results</i>
	See FCA-OM.2 and FCA-OM.4 above – immediate results of on-line Future CA are in the form of CA results (summaries of overloads and violations), CA warnings and alarms for operators, remedial action suggestions for operators, and direct remedial action commands issued by Future CA.
	Overall result of Future Contingency Analysis: a secure and stable power system, even after contingency events occur.

2.2 Architectural Issues in Interactions

Elaborate on all architectural issues in each of the steps outlined in each of the sequences above. Reference the Step by number.



Microsoft Excel
Worksheet

2.3 Diagram

For clarification, draw (by hand, by Power Point, by UML diagram) the interactions, identifying the Steps where possible.

DIAGRAM OF CONTINGENCY ANALYSIS OFF-LINE STUDY MODE
(CA-SM steps)

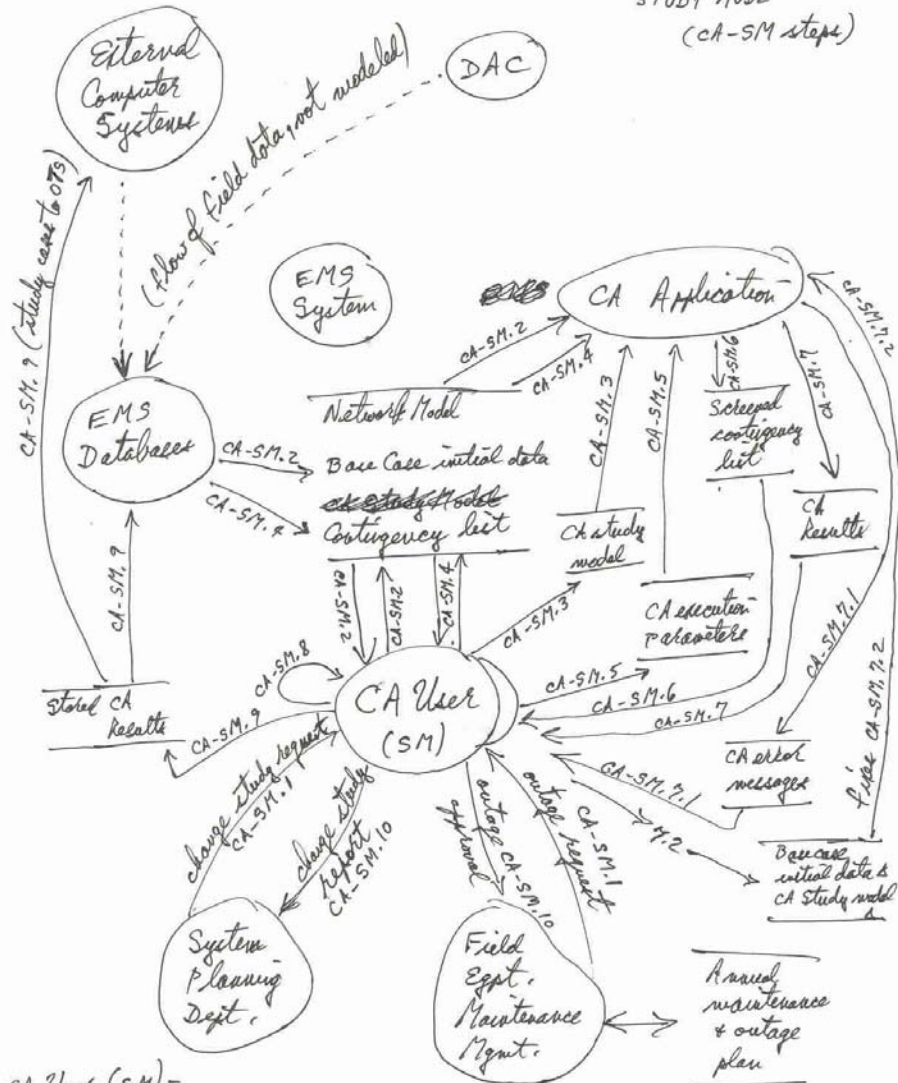

CA User (SM) =
 • power system planner
 • equipment outage planner/scheduler

J. BOBYN
 Mar. 1/04 Rev. 0

3 Auxiliary Issues

3.1 References and contacts

Documents and individuals or organizations used as background to the function described; other functions referenced by this function, or acting as “sub” functions; or other documentation that clarifies the requirements or activities described. All prior work (intellectual property of the company or individual) or proprietary (non-publicly available) work must be so noted.

ID	Title or contact	Reference or contact information
[1]		
[2]		

3.2 Action Item List

As the function is developed, identify issues that still need clarification, resolution, or other notice taken of them. This can act as an Action Item list.

ID	Description	Status
[1]		
[2]		

3.3 Revision History

For reference and tracking purposes, indicate who worked on describing this function, and what aspect they undertook.

No	Date	Author	Description
0.95	February 29, 2004	J. Bobyn	Completed Rev. 0.95 for posting to project site. <ul style="list-style-type: none">Performed additions, edits and changes according to reviews with Jamshid Sharif-Askary and Mark Adamiak

No	Date	Author	Description
			<ul style="list-style-type: none"><li data-bbox="835 266 1801 298">• Still needs a process/data flow diagram for section 2.3 to be complete Rev. 1.0

WAMAC Emergency Operations Baseline

1 Descriptions of Function

All prior work (intellectual property of the company or individual) or proprietary (non-publicly available) work should be so noted.

1.1 Function Name

Wide Area Monitoring and Control Systems - Emergency Operations Baseline

1.2 Function ID

IECSA identification number of the function

1.3 Brief Description

The purpose of the Wide Area Monitoring and Control Systems - Emergency Operations function is to provide communications services permitting an operator to take the following actions in response to a fault in the power system:

Locate the fault

Verify that protection has operated correctly to clear the fault

Shed load to ensure that the fault does not cause an overload of unaffected lines

Manually re-route power to restore service to subscribers

Dispatch crews and emergency teams to fix the fault

Capture fault recordings so engineers can later analyze the cause of the fault

This function also addresses handling of environmental and security alarms.

1.4 Narrative

A complete narrative of the Function from a Domain Expert's point of view, describing what occurs when, why, how, and under what conditions. This will be a separate document, but will act as the basis for identifying the Steps in Section 2.

Emergency operations are organizational sequences of activities that involve multiple integrated actors exchanging information when a fault is detected on a power system. These activities are integrated through the use of Wide Area Control and Monitoring Systems

(WAMACS) that provide operational control over the distributed network of actors that comprise the SCADA system. Each utility maintains their own WAMACS but in the future these systems must be linked to provide overall control and monitoring across multiple organizations to meet the future demands of the suppliers and users of electrical power.

The remainder of this narrative describes an example scenario illustrating the characteristics and sequence of activities that occur on the power system during Emergency Operations. The example is based on a typical substation with a SCADA system.

1.4.1 Initial State

When a typical substation is operating in the normal state, called initial state for the purposes of this discussion, there are at least two incoming lines connected to two transformers that feed two separate buses that supply the source side of the feeder circuits. In the initial state both lines and transformers would be energized and the main breakers would be closed to allow both buses to be energized. The bus tie breaker between the two buses is closed so both transformers are sharing the load from all four feeders.

The lines, transformers, buses and feeders each are monitored by separate protection relays that can sense abnormalities in the zone of protection that they are responsible for and isolate faults in the zone by opening the appropriate breaker. Adjacent protection relay zones overlap to ensure that there is protection at every point in the system. Incoming line relays are responsible for a zone of protection that extends out of the substation and down the line a certain distance. The other end of the line is usually owned by the power transmitter and there is similar distance protection on that end of the line. If a fault occurs on the line both relays report the distance and direction to the fault. There should be an overlap in the two fault reports and this is the portion of the line that the dispatched maintenance crew will check first for the fault.

In the initial state the SCADA system, shown in Figure 1, would have no outstanding alarms or abnormal readings that would require the operator to take action. The SCADA system, which is made up of these protection IEDs, monitor the critical areas of the substation and report data to the DataConcentrator. The protection IEDs are most often located within a substation, but may also be located at remote sites or on pole-tops.

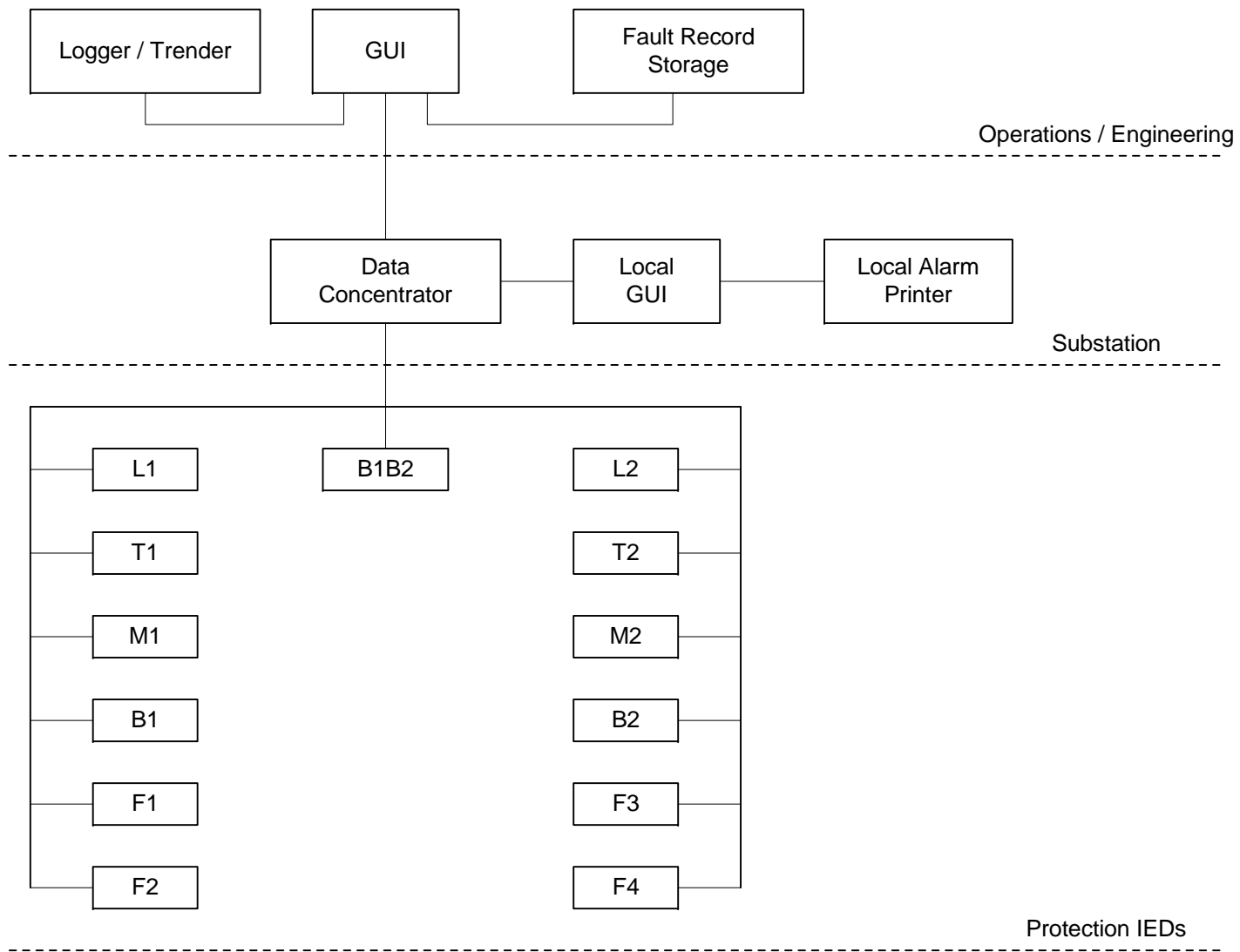

Figure 1: SCADA System

GUI – Graphical User Interface

L1/L2 – Line Distance relays

T1/T2 – Transformer relays

M1/M2 – Main Breaker relays

B1/B2 – Bus relays

F1/F2/F3/F4 – Feeder relays

The DataConcentrator is located in the substation and is connected with a communication link to each IED. The substation is often equipped with a local GUI and an alarm logger. The DataConcentrator is connected through a different communication link to one or more GUIs. GUIs can be local to the substation or in an operations center that monitors several substations.

The operator is located in close proximity to the GUI, which is the operator's window into the substation. The operations center is usually equipped with a logging and trending system to store analog quantities on a regular interval or on a change to display the quantities on a graph. There also must be a method of storing and accessing fault records that are used by engineers to analyze the faults.

DataConcentrators, GUIs, and the communications links between them and the IEDs are usually redundant, and perform switchover if one link fails. Reliability is very important.

1.4.2 Fault Occurrence and Detection

There are several places where a fault can occur on this system and several different ways the equipment can be used to isolate different fault conditions. Some very simple fault scenarios are used in the discussion to help describe Emergency Operations. Each zone of protection is equipped with a protection IED, or relay, that monitors the state of the system and the values of the electrical quantities that are relevant to the zone of protection. If a fault occurs the relay is able to cause a breaker and sometimes also a switch to operate to isolate the fault.

If a fault occurs some distance down the incoming transmission line the line distance relay associated with that zone is responsible for detecting the fault, tripping the main breaker and disconnecting the incoming line disconnect switch. This isolates the substation from the fault so that the excessive current associated with the fault does not damage any equipment in the substation. This operation must occur within one cycle of the power waveform and this precise timing requires accurate time synchronization to be applied to the device so that the time the event occurred and the sequence of events can be determined later. The line distance relay also reports the system changes caused by the fault to the DataConcentrator which in turn passes them to the GUI where the state changes are reported as system alarms to the operator.

A fault occurring in a different zone of protection would be handled in a similar way. For example the transformer relay is responsible for the closed zone of protection around the transformer. If a transformer fault occurs it opens the main breaker and then the disconnect switch.

1.4.3 Fault Record Generated

Often a fault recorder is monitoring the power system quantities at one or more strategic locations around the substation. The protection IEDs or the RTU often have built in fault recorders that can capture data before, during and after a fault. Engineers will use this information to determine the type, magnitude and profile of the fault.

During normal operation the fault recorder is storing several cycles worth of data continuously. If a fault occurs it triggers the recorder to stop overwriting the pre trigger data and continue recording the actual fault data. In this way the engineer is able to observe the stable condition before the fault, (pre trigger), and exactly what happened at the instant the fault occurred and then the post fault profile which is the system reaction to the fault.

The fault data profile usually has separate channels for each of the three phase voltages and currents and can use other signals as well. The fault data is usually stored in a standard format in the IED or in the fault recorder that captured the data. A signal, in the form of an alarm, is sent to the data concentrator and subsequently to the GUI to notify the operator that a fault file is available to be analyzed.

1.4.4 Change of State

Faults cause the system to change state, usually because one of the protection IEDs has tripped a breaker. The state of the breaker is detected by a change in position in the detection device located in close proximity to the breaker. This change of state is generally

detected by the IED and reported to the DataConcentrator or detected directly by the DataConcentrator in other situations. The DataConcentrator determines if it is required to communicate the change of state to the GUI in which case it does. The DataConcentrator's function is to translate the protocol that contains the state change between the IED and the GUI.

Often there is a large number of devices in the substation, slow communication links, legacy protocols that do not have timestamps, sorting requirements or the requirement to send the change of state data to more than one GUI. All these are reasons why a DataConcentrator is required.

1.4.5 Alarm

A fault causes a breaker to trip which causes a change of state in the system which is converted to an Alarm by the GUI to notify the operator of the system change. Usually the alarm shows up as a flashing text message at the bottom of the active screen on the operators GUI and is combined with an audible signal in case the operator is not looking at the screen. The flashing and audible signal stop when the alarm is acknowledged. Characteristics associated with each different alarm are preconfigured such as location, priority and description.

The trip notification is a digital change of state, accompanied by a timestamp indicating when the event occurred. The timestamp is important because it may be later used to reconstruct a "sequence of events" indicating when various devices and personnel within the utility took action to address the fault. For this reason, time between devices within the SCADA system is typically synchronized to within 1 millisecond. Sometimes this takes place over serial links or LANs, but most commonly is performed by connecting satellite time sources to each device.

1.4.6 Retrieve Fault Record

The Fault Record is stored in the IED and a notification that the record exists is provided and can be obtained. There is either a manual or automated process in place for retrieving the Fault Record so that it can be studied. The file is retrieved by the DataConcentrator and passed to the GUI where it is stored and cataloged. The information in the record is analog and digital data that was captured before, during and after the fault.

There are several issues that can limit the systems ability to retrieve faults:

Fault records contain large volumes of data that some devices cannot handle.

Not all DataConcentrators can forward file data.

Legacy protocols may not support file transfer.

Existing communication links may make the transfer of large files too slow.

Some arrangements require personnel to be dispatched to the site to extract the Fault Record directly from the IED.

1.4.7 Change in Line Load

When a breaker trips there is no longer a path for electrical energy to flow from the live side of the breaker through to the other side. The breaker has isolated the downstream equipment by opening the circuit to stop the energy from getting to the equipment. This always causes a change to the entire load that the substation is connected to. Anything downstream of the breaker is not running because the power is removed unless there is a way to feed the load with energy from another line. The IED monitoring the changed load is responsible for detecting and reporting the change in the quantities, such as voltage and current. The IED provides the information necessary to understand how the system has changed.

1.4.8 Analog Data Change

When Analog Data changes in the IED it is reported to the DataConcentrator first. If the DataConcentrator identifies the data as being of interest to one or more of the GUIs that are connected to it and the change in value is significant in that it exceeds a preconfigured deadband it translates the data from the IED to the GUI through the communications protocols.

1.4.9 Change in System Load

When the System Load changes and the GUI is notified of the change by the DataConcentrator it must perform several activities for the operators to be able to investigate:

Maps the point number of the protocol to the appropriate location in the database.

Scales the data appropriately for accurate display in the correct units.

Updates any values currently being displayed.

Raises appropriate alarms associated with the quantities.

Logs and trends data if required.

1.4.10 Shed Load or Restore Power

The SystemOperator addresses the alarm by viewing the system state displayed on the GUI. IEDs pass load and switch state change information to the GUI through the DataConcentrator, permitting the SystemOperator to:

Determine the location of the fault

Verify that the protection equipment has operated properly to clear the fault (isolate the faulted section).

See the impact of the fault isolation on the rest of the power system.

The SystemOperator takes action to address the alarm. This action may include any of the following items:

Reset any breakers that should not have tripped.

Disconnect the faulted section of line from the remainder of the power system, if protection equipment has not already done so.

Re-route power so the loss of the faulted line does not cause other portions of the system to be overloaded.

Re-route and restore power so the affected area is minimized.

Disconnect (shed) load from the power system if there is no other way to prevent an overload.

From the point of view of the communications network, the effect of all these actions is the same: the SystemOperator sends control requests to various IEDs within the substation and elsewhere in the network, to either open or close switches or breakers. The SystemOperator enters these controls at the GUI. They are forwarded through the DataConcentrator to the correct IED. At any point in this path, the SCADA System may reject the controls if they violate safety rules, e.g. closing a switch to run power back onto the faulted line. This is called Interlocking and is discussed further in the Automated Controls use case.

1.4.11 Control

If the operator has sent a control the GUI must format the control into an appropriate request, usually a Select-Before-Operate service is used, for the DataConcentrator or IED and sent through the protocol. The control can be digital such as changing the state of a breaker or an analog setpoint such as changing the position of a valve. The information contained in the control request includes: Point number, operation, duration and setpoint value.

1.4.12 Forward Control

If the operator has sent a control that is destined for a protection IED the DataConcentrator must forward the request to the IED. The IED acknowledgement to the request is received by the DataConcentrator first and then forwarded to the GUI. This is a protocol translation function performed by the DataConcentrator. The indication of the correct state of the control being achieved or the alarm to indicate that the control failed is also received first by the DataConcentrator and then forwarded to the GUI for display on the

screens the operator is looking at. When forwarding the control the DataConcentrator uses the Select-Before-Operate service similar to the GUI. The DataConcentrator can support multiple GUIs issuing controls if required.

1.4.13 Locate Fault

The protection IEDs that monitor the lines, L1 and L2, and the feeders, F1, F2, F3 and F4, usually have the capability of locating the fault by measuring the impedance of the line, and then comparing it to known impedances that exist when the fault is not present and preconfigured characteristics of the line. Usually the direction and distance to the fault are outputs of the IEDs calculations. This information is used to make operational and maintenance decisions by the DataConcentrator, the GUI and the operator.

1.4.14 Display Fault Location

The GUI is capable of interpreting the fault data and providing a meaningful display of the fault location in terms of the location and distance values that include the overlap provided by two different relays reporting the same fault from different locations. It also logs the distance and direction for future reference by engineers that need to study the characteristics of the fault.

1.4.15 Dispatch

The operator dispatches a maintenance crew to an area where it is believed that the fault exists based on the distance and direction that was logged and displayed by the GUI. This dispatching may take place through many types of media, including radio, telephone, a separate dispatcher, or a computerized system. Whatever mechanism the operator uses must be wireless at some point because the crews are mobile. The crew does not utilize the SCADA network on their own but receives orders directly from the operator.

1.4.16 Notify

The operator is also responsible for notifying engineers that study the fault characteristics to determine why the faults occurred where they did. The priority of this step is increased if the fault also affected service in a region. The information that these personnel use is obtained from the ProtectiveRelay, the DataConcentrator, the GUI and the operator. The personnel interested in the data are emergency personnel, protection engineers, system stability analysts and management. The process of notifying additional personnel may or may not be automated but typically does not use the SCADA network.

1.5 Actor (Stakeholder) Roles

Describe all the people (their job), systems, databases, organizations, and devices involved in or affected by the Function (e.g. operators, system administrators, technicians, end users, service personnel, executives, SCADA system, real-time database, RTO, RTU, IED, power system).

Typically, these actors are logically grouped by organization or functional boundaries or just for collaboration purpose of this use case. We need to identify these groupings and their relevant roles and understand the constituency. The same actor could play different roles in different Functions, but only one role in one Function. If the same actor (e.g. the same person) does play multiple roles in one Function, list these different actor-roles as separate rows.

Grouping (Community) ' ,		Group Description
Actor Name	Actor Type (person, device, system etc.)	Actor Description
SystemOperator	Person	Prime actor in this function. Responds to emergencies by operating the control system and dispatching personnel.
Graphical User Interface (GUI)	Device	Displays status of system for the SystemOperator and permits the SystemOperator to control the system. Often mistakenly called the SCADA system.
DataConcentrator	Device	Collects, stores, and filters data between the GUI and multiple IEDs. Often converts from one communications media to another. Often converts from one protocol suite to another. May or may not exist within the SCADA system.
IED	Device	End device monitoring and controlling primary equipment. May also be called a Remote Terminal Unit (RTU). Detects and reports faults and system state. May incorporate Protection and FaultRecorderDevice functions.
ProtectiveRelay	Device	Class of IED that responds to faults by tripping a breaker according to control logic, based on the monitoring of current and voltage values, and on communications with other ProtectiveRelays.
FaultRecorderDevice	Device	Class of IED that collects, stores, and reports waveform samples and other state information associated with a fault.
SCADASystem	System	Supervisory Control and Data Acquisition System. Consists of GUI, DataConcentrator and IEDs, interconnected to provide monitoring and control of the power system.
FieldPersonnel	Person	Dispatched by SystemOperator to fix a fault.
Protection Engineer	Person	Notified by SystemOperator to analyze a fault.
EmergencyPersonnel	Person	Security, medical, maintenance, or other personnel called by the SystemOperator in response to a fault or other emergency.
Subscriber	Person	End user of the power system
ManagementPersonnel	Person	Notified by SystemOperator in case of service-affecting outages.

1.6 Information exchanged

Describe any information exchanged in this template.

Information Object Name	Information Object Description
Point Number	The unique index of the point that is associated with the state or value that is currently of interest and is one of the points being monitored in the system. This number is a certain point in the IED, which becomes a different point in the DataConcentrator database and in turn becomes a different point number in the protocol that communicates with the GUI. There could be several mapping stages at each device the point goes through.
Timestamp	A data event such as a change of state is associated with a timestamp that indicates when the change of state occurred relative to the system clock. There is often a 1 ms accuracy requirement that specifies that the timestamp must be within 1 millisecond of the actual event. The time stamp is applied at the device that is responsible for processing the field point for which the event occurred. The timestamp is then associated with the change of state event that is reported to the other devices in the system. These time stamped events can occur on the IED or the DataConcentrator if it is equipped with equipment to monitor field devices.
State	Digital Input with value Open or Closed, 0 or 1, Trip or Closed, Off or On, Normal or Alarm, etc. The change of state of a field input such as a switch. Includes: a point number, the quality of the point (online/offline or valid/invalid), the new state, and the time the state changed which is typically accurate to millisecond resolution. If the state of the input is Trip it represents a particular type of state change that indicates through its point number that a certain breaker has tripped and is now open. Includes all the same data as any state change but state is unique to the application.
Fault Indication	Point Number + Timestamp + State
Location	The location of a point that has undergone a state change is represented on the GUI oneline graphic and in any number of other graphics. On the oneline the states of breakers are represented by filling in a box and the location of the breaker is provided by the labeling and location on the oneline graphic.
Priority	Varies; typically H,M,L, colored. Priorities are usually represented by different coloured objects or different locations in a graphic that show it's ranking. Priorities can be established on groups of data by assignment in the protocol between two devices.
Description	Text description of the condition that is represented by a certain digital input point in a certain state. These are used as the alarm descriptions for indicating when an alarm is established or cleared.
Notification of Alarm	Location + Priority + Description + State + Timestamp
Analog and digital sample file	Usually COMTRADE or PQDIF. Sometimes IEC 60870-5-103. Typically around 1Mb.
Voltage, Current	Analog values used in the system are often a twelve-bit or sixteen-bit integer that must be scaled for display in

Information Object Name	Information Object Description
	engineering units. The information includes: a point number, the quality of the point, and the value. It may or may not include a millisecond timestamp if the value is associated with a change event. A voltage would be scaled to engineering units of V or kV and a current in A. This is usually converted in the GUI which is a PC platform that supports floating point easily. This preserves the resolution in the raw data coming through the protocol.
Change in Line Load	Point Number + Voltage, Current
Operation	A control request is used to initiate a digital field operation such as close a breaker or switch. A setpoint request is used to initiate an analog field operation such as close the valve position by a certain amount. The operation required is defined in the protocol and can be a Trip or Close, Raise or Lower for a digital control or Open or Close or Raise or Lower for an analog event. The operation type is selected by the operator when the request is setup.
Duration	The time in milliseconds that the coil of a relay will be energized in the device that is required to perform the requested operation. The time is usually determined by how long it takes to pick up the field operation which seals itself in for the full duration of the operation. Most digital controls are short pulses between 500 and 1000 ms. Sometimes the operator enters the desired duration and sometimes it is pre configured in the device.
Setpoint Value	The setpoint value is the absolute engineering value that the field device is supposed to reach when the operation is complete. This value is entered by the operator and represents the desired outcome of the operation. The result of the operation is usually fed back to the operator using a separate sensor so the error between the setpoint and actual can be observed.
Send Control	Point Number + Operation + Duration + Setpoint Value
Direction	In a Fault Location Algorithm the direction to the fault is indicated as part of the information required to locate the fault.
Distance	In a Fault Location Algorithm a calculation is performed where the impedance of the conductor normally is compared to the impedance of the fault. The result is in an estimate of how far from the relay the fault is located in miles or kms. The value must be scaled from integer to engineering units and displayed on a GUI graphic in a meaningful way for the operator.
Locate Fault	Direction + Distance
Display Location	Location + Distance
Directions	When the operator dispatches a maintenance crew to correct a fault on a line part of the information includes the expected location of the fault and directions on how to find and access the location.
Request to contact operator	This is a voice, telephone, pager or email message to an operator, requesting that a particular action be taken, e.g. opening a particular switch. Includes: the operation to be taken (e.g. trip, close), and the location (e.g. the device name or feeder location). This may be graphical, text, or voice message that is sent to the operator and requires an acknowledgement and an action for the operator to perform. The procedures for opening breakers and switches and isolating parts of circuits are operationally critical because equipment damage and personal injury are risks if the operation is incorrect. Utility organizations have strict procedures which are followed to execute these operations.

1.7 Activities/Services

Describe or list the activities and services involved in this Function (in the context of this Function). An activity or service can be provided by a computer system, a set of applications, or manual procedures. These activities/services should be described at an appropriate level, with the understanding that sub-activities and services should be described if they are important for operational issues, automation needs, and implementation reasons. Other sub-activities/services could be left for later analysis.

Activity/Service Name	Activities/Services Provided
Display and Manage Alarms	Identifies that a fault or other emergency has occurred and the priority of the alarm. May suppress some alarms in favor of concentrating the operator's attention on critical information.
Display System State	Permits the SystemOperator to verify that protection has operated properly to clear the fault, and to view the current state of load on various components of the system
Manually Shed Load	Permits the SystemOperator to disconnect load from the power system so the fault will not cause cascading failures. Load shedding may also be done automatically, but that is discussed in another function.
Manually Restore Power	Permits the SystemOperator to restore power to Subscriber by re-routing through the operation of switches and breakers.
Locate Fault	Permits the SystemOperator to determine where the fault has occurred
Record Fault and Collect Fault Records	Collects and stores waveform data and other fault information for later analysis
Alert Additional Personnel	Alerts managers, engineers, troubleshooters to the fault via telephone, email, pagers, etc.
Dispatch Crews	Directs FieldPersonnels to the site of the fault
Dispatch EmergencyPersonnel	Directs Emergency personnel to the site of a problem

1.8 Contracts/Regulations

Identify any overall (human-initiated) contracts, regulations, policies, financial considerations, engineering constraints, pollution constraints, and other environmental quality issues that affect the design and requirements of the Function.

Contract/Regulation	Impact of Contract/Regulation on Function

Policy	From Actor	May	Shall Not	Shall	Description (verb)	To Actor
Fault notification	SCADASystem			X	Report faults within 1 second	SystemOperator
Load monitoring	SCADASystem			X	Report load values within 2 seconds	SystemOperator
Control	SCADASystem			X	Change switch states within 2 seconds	SystemOperator

Constraint	Type	Description	Applies to

2 Step by Step Analysis of Function

Describe steps that implement the function. If there is more than one set of steps that are relevant, make a copy of the following section grouping (Preconditions and Assumptions, Steps normal sequence, and Steps alternate or exceptional sequence, Post conditions)

2.1 Steps to implement function

Name of this sequence.

2.1.1 Preconditions and Assumptions

Describe conditions that must exist prior to the initiation of the Function, such as prior state of the actors and activities

Identify any assumptions, such as what systems already exist, what contractual relations exist, and what configurations of systems are probably in place

Identify any initial states of information exchanged in the steps in the next section. For example, if a purchase order is exchanged in an activity, its precondition to the activity might be 'filled in but unapproved'.

Actor/System/Information/Contract	Preconditions or Assumptions
SCADASystem	No outstanding alarms

2.1.2 Steps – Normal Sequence

Describe the normal sequence of events, focusing on steps that identify new types of information or new information exchanges or new interface issues to address. Should the sequence require detailed steps that are also used by other functions, consider creating a new “sub” function, then referring to that “subroutine” in this function. Remember that the focus should be less on the algorithms of the applications and more on the interactions and information flows between “entities”, e.g. people, systems, applications, data bases, etc. There should be a direct link between the narrative and these steps.

The numbering of the sequence steps conveys the order and concurrency and iteration of the steps occur. Using a Dewey Decimal scheme, each level of nested procedure call is separated by a dot ‘.’. Within a level, the sequence number comprises an optional letter and an integer number. The letter specifies a concurrent sequence within the next higher level; all letter sequences are concurrent with other letter sequences. The number specifies the sequencing of messages in a given letter sequence. The absence of a letter is treated as a default 'main sequence' in parallel with the lettered sequences.

Sequence 1:

- 1.1 - Do step 1
- 1.2A.1 - In parallel to activity 2 B do step 1
- 1.2A.2 - In parallel to activity 2 B do step 2
- 1.2B.1 - In parallel to activity 2 A do step 1
- 1.2B.2 - In parallel to activity 2 A do step 2
- 1.3 - Do step 3
- 1.3.1 - nested step 3.1
- 1.3.2 - nested step 3.2

Sequence 2:

- 2.1 - Do step 1
- 2.2 - Do step 2

#	Event	Primary Actor	Name of Process/Activity	Description of Process/Activity	Information Producer	Information Receiver	Name of Info Exchanged	Additional Notes	IECSA Environments
#	Triggering event? Identify the name of the event. ¹	What other actors are primarily responsible for the Process/Activity? Actors are defined in section 0.	Label that would appear in a process diagram. Use action verbs when naming activity.	Describe the actions that take place in active and present tense. The step should be a descriptive noun/verb phrase that portrays an outline summary of the step. "If ...Then...Else" scenarios can be captured as multiple Actions or as separate steps.	What other actors are primarily responsible for Producing the information? Actors are defined in section 0.	What other actors are primarily responsible for Receiving the information? Actors are defined in section 0. (Note – May leave blank if same as Primary Actor)	Name of the information object. Information objects are defined in section 1.6	Elaborate architectural issues using attached spreadsheet. Use this column to elaborate details that aren't captured in the spreadsheet.	Reference the applicable IECSA Environment containing this data exchange. Only one environment per step.
1.1	Fault	ProtectiveRelay	Report Fault	Detects fault and trips appropriate breaker.	ProtectiveRelay	DataConcentrator (sometimes GUI)	Fault Indication	Must be detected within a cycle. Timestamp requires accurate synchronization	Inter-Field Equipment
1.2		FaultRecorderDevice	Generate Report	Send indication that a fault record is available.	FaultRecorderDevice	DataConcentrator or GUI	Fault Indication		Inter-Field Equipment

¹ Note – A triggering event is not necessary if the completion of the prior step – leads to the transition of the following step.

#	Event	Primary Actor	Name of Process/Activity	Description of Process/Activity	Information Producer	Information Receiver	Name of Info Exchanged	Additional Notes	IECSA Environments
1.3		DataConcentrator	Report COS	Identifies data as being of interest to the GUI. Translates protocol from IED to GUI.	DataConcentrator	GUI	Fault Indication	Concentrator required due to slow links, large numbers of devices. Legacy protocols may not support timestamp. May sort events by timestamp before transmission May distribute to multiple GUIs.	Lower Security DAC
1.4		GUI	Notification of Alarm	Identifies the trip as an alarm condition and displays notification on screen. Maps point number and state to human-readable information. Logs the alarm / change of state.	GUI	SystemOperator	Notification of Alarm	Location, priority, description must all be pre-configured.	Intra-Control Center
2.1	Retrieve Fault	DataConcentrator or GUI	Retrieve Fault	Retrieves the fault record from the fault recorder.	IED	DataConcentrator or GUI	Analog and digital sample file	Large volumes of data. Many data concentrators cannot forward files. Legacy protocols may not support file transfer. Existing links may make transfer slow. Sometimes may need to send operator to site.	Lower Security DAC

#	Event	Primary Actor	Name of Process/Activity	Description of Process/Activity	Information Producer	Information Receiver	Name of Info Exchanged	Additional Notes	IECSA Environments
3.1	Change in line load	ProtectiveRelay	Change in line load	Detect change in load due to protection activity.	IEDs	DataConcentrator or GUI	Change in Line Load		Inter-Field Equipment
3.2		DataConcentrator	Change in Analog Data	Identifies data as being of interest to the GUI. Identifies the change as being significant (deadband). Converts communications protocol from IED to GUI.	DataConcentrator	GUI	Change in Line Load	May distribute to multiple GUIs.	Lower Security DAC
3.3		GUI	Load Change	Maps point number to database. Updates values if currently on display. Raises alarm if threshold exceeded. Logs data if it is being trended.	GUI	SystemOperator	Voltage, Current	Scaling is usually pre-configured	Intra-Control Center
4.1	Shed Load, or Restore Power	SystemOperator	Shed Load / Restore Power	Operates control	SystemOperator	GUI			Intra-Control Center
4.2		GUI	Send Control	Sends control or setpoint	GUI	DataConcentrator or IED	Send Control	Normally uses Select-Before-Operate service. Occasionally broadcast.	Lower Security DAC
4.3		DataConcentrator	Forward Control	Translates control or setpoint and sends to IED.	DataConcentrator	IED	Send Control	Uses Select-Before-Operate service. Often supports multiple GUIs.	Inter-Field Equipment

#	Event	Primary Actor	Name of Process/Activity	Description of Process/Activity	Information Producer	Information Receiver	Name of Info Exchanged	Additional Notes	IECSA Environments
5.1	Locate Fault	ProtectiveRelay	Locate Fault	Measures impedance of line and calculates distance based on pre-configured characteristics of the line.	ProtectiveRelay	DataConcentrator or GUI	Locate Fault		Inter-Field Equipment
5.2		GUI	Display Location	Displays location and distance on GUI in a manner that shows overlap. Logs distance and direction.	GUI	SystemOperator	Display Location		Intra-Control Center
6.1	Dispatch	SystemOperator	Dispatch FieldPersonnel	Dispatches crew based on fault location log and display.	SystemOperator	FieldPersonnel	Directions	Currently does not use SCADA network	User Interface
7.1	Notify	SystemOperator	Notify Personnel	Notifies personnel that a service-affecting fault has occurred based on an alarm condition.	GUI, DataConcentrator, SystemOperator	Protection Engineer, ManagementPersonnel	Request to contact operator	May or may not be automated. Typically does not use SCADA network	User Interface

2.1.3 Steps – Alternative / Exception Sequences

Describe any alternative or exception sequences that may be required that deviate from the normal course of activities. Note instructions are found in previous table.

#	Event	Primary Actor	Name of Process/Activity	Description of Process/Activity	Information Producer	Information Receiver	Name of Info Exchanged	Additional Notes	IECSA Environments

2.1.4 Post-conditions and Significant Results

Describe conditions that must exist at the conclusion of the Function. Identify significant items similar to that in the preconditions section.

Describe any significant results from the Function

Actor/Activity	Post-conditions Description and Results
FieldPersonnel / Protection Engineers	Identify fault, fix problem. Check system is ready to have power restored.
SystemOperator	Uses SCADA system to restore power system to original state.

2.2 Architectural Issues in Interactions

Elaborate on all architectural issues in each of the steps outlined in each of the sequences above. Reference the Step by number.



Microsoft Excel
Worksheet

2.3 Diagram

For clarification, draw (by hand, by Power Point, by UML diagram) the interactions, identifying the Steps where possible.

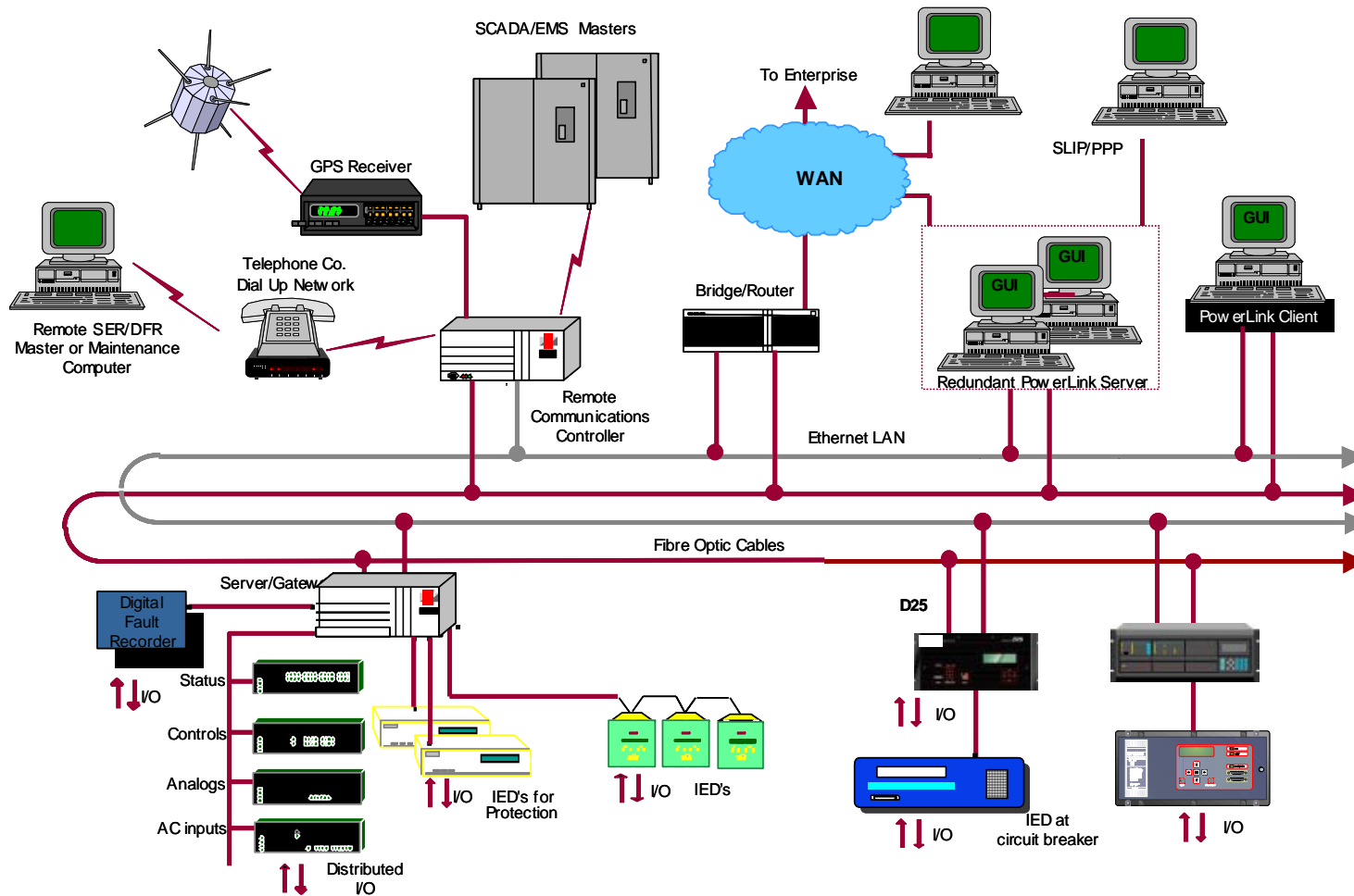

3 Auxiliary Issues

3.1 References and contacts

Documents and individuals or organizations used as background to the function described; other functions referenced by this function, or acting as “sub” functions; or other documentation that clarifies the requirements or activities described. All prior work (intellectual property of the company or individual) or proprietary (non-publicly available) work must be so noted.

ID	Title or contact	Reference or contact information

3.2 Action Item List

As the function is developed, identify issues that still need clarification, resolution, or other notice taken of them. This can act as an Action Item list.

ID	Description	Status

3.3 Revision History

For reference and tracking purposes, indicate who worked on describing this function, and what aspect they undertook.

No	Date	Author	Description
0.			

This page intentionally left blank.

Inter-Area Oscillation Damping

1 Descriptions of Function

All prior work (intellectual property of the company or individual) or proprietary (non-publicly available) work should be so noted.

1.1 Function Name

Inter-Area Oscillation Damping

1.2 Function ID

T-4.18,T-6.10

“Automation system controls voltage, var and power flow based on algorithms, real-time data, and network-linked capacitive and reactive components.”

1.3 Brief Description

Low frequency Inter-area oscillations are detrimental to the goals of maximum power transfer and optimal power flow. An available solution to this problem is the addition of power system stabilizers to the automatic voltage regulators on the generators. The damping provided by this technique provides a means to minimize the effects of the oscillations.

1.4 Narrative

Inter-Area oscillations result from system events coupled with a poorly damped electric power system. The oscillations are observed in the large system with groups of generators, or generating plants connected by relatively weak tie lines. The low frequency modes (0.1 to 0.8 Hz) are found to involve groups of generators, or generating plants, on one side of the tie oscillating against groups of generators on the other side of the tie. These oscillations are undesirable as they result in sub-optimal power flows and inefficient operation of the grid. The stability of these oscillations is of vital concern.

Although Power System Stabilizers exist on many generators, their effect is only on the local area and do not effectively damp out inter-area oscillations. It can be shown that the inter-area oscillations can be detected through the analysis of phasor measurement units (PhasorMeasurementUnit) located around the system. In a typical implementation, one or more of the generators in a system are selected as Remote Feedback Controllers (RFCController). The RFCController received synchronized phasor measurements from one or more remote phasor

sources. The RFCController analysis the phase angles from the multiple sites and determines if an inter-area oscillation exists. If an oscillation exists, a control signal is sent to the generator’s voltage regulator that effectively modulates the voltage and effectively damps out the oscillations.

To overcome the inter-area oscillation, new equipment such as Static Var Compensator (SVC) and various Flexible AC Transmission System (FACTSDevice) devices, are being increasingly used. These techniques have become possible due to the recent advancement in power electronic technology. The involvement of SVC and FACTSDevice in transmission network is through the so-called Variable Series Compensation (VSCController). Besides the FACTSDevice devices, the application of Super-Conducting Magnetic Storage (SMESDevice) to enhance the inter-area oscillation damping is also reported.

The key to coordinate RFCController, VSCController and various controllers is the using of PhasorMeasurementUnit synchronized with the Global Positioning Satellite (GPS).

The natural frequency and damping of the inter-area mode depends on the weakness of the tie and on the power transferred through the tie. The action of a dc link, parallel to the ac tie, is to strengthen the tie. Connection of two areas, through a dc link alone, does not introduce an inter-area mode owing to the asynchronous nature of a dc tie. Therefore, the inter-area instability is avoided. Indeed, that is one of the reasons for the growth of dc links.

1.5 Actor (Stakeholder) Roles

Describe all the people (their job), systems, databases, organizations, and devices involved in or affected by the Function (e.g. operators, system administrators, technicians, end users, service personnel, executives, SCADA system, real-time database, RTO, RTU, IED, power system). Typically, these actors are logically grouped by organization or functional boundaries or just for collaboration purpose of this use case. We need to identify these groupings and their relevant roles and understand the constituency. The same actor could play different roles in different Functions, but only one role in one Function. If the same actor (e.g. the same person) does play multiple roles in one Function, list these different actor-roles as separate rows.

<i>Grouping (Community)</i>		<i>Group Description</i>
<i>Inter-Area Oscillation Damping</i>		
<i>Actor Name</i>	<i>Actor Type (person, device, system etc.)</i>	<i>Actor Description</i>
PhasorMeasurementUnit	Device	Phasor Measurement Unit (PhasorMeasurementUnit) - Calculate and transmit synchronized phasors at the required rate

<i>Grouping (Community)</i>		<i>Group Description</i>
<i>Inter-Area Oscillation Damping</i>		
<i>Actor Name</i>	<i>Actor Type (person, device, system etc.)</i>	<i>Actor Description</i>
RFCController	Device	Remote Feedback Controller (RFCController) - Receive phasor measurement data from one or more Phasor Measurement Units; Detect inter-area oscillations; Issue local controls to the generator voltage regulator to damp out the inter-area oscillation
AVRController	Device	Automatic Voltage Regulator (AVRController) - Receives controls from the RFCController and adjusts the generator voltage based upon the received signal
VSCController	Device	Variable Series Compensation (VSCController) - Receive phasor measurement data from PMUs located at both sides of the tie, adjust the variable series reactance by controlling the SVC and FACTSDevice devices.
SMESDevice	Device	Superconducting Magnetic Energy Storage (SMESDevice) - A energy storage device that stores energy in the magnetic field created by the flow of direct current in a coil of superconducting material that has been cryogenically cooled. It is designed to improve power quality, reliability and operational performance.
SMESDeviceSMESController	Device	Superconducting Magnetic Energy Storage system controller
FACTSDevice	Device	A power electronics based system and other static equipment that provide control one or more ac transmission system parameters to enhance controllability and increase power transfer capability,

Replicate this table for each logic group.

1.6 Information exchanged

Describe any information exchanged in this template.

<i>Information Object Name</i>	<i>Information Object Description</i>
Synchro Phasor	A phasor calculated from data samples using a standard time signal as the reference for the sampling process. In this case, the phasors from remote sites have a defined common phase relationship.
Controller Settings	Set points of the AVRController, FACTSDevice and SMESDevice systems.

1.7 Activities/Services

Describe or list the activities and services involved in this Function (in the context of this Function). An activity or service can be provided by a computer system, a set of applications, or manual procedures. These activities/services should be described at an appropriate level, with the understanding that sub-activities and services should be described if they are important for operational issues, automation needs, and implementation reasons. Other sub-activities/services could be left for later analysis.

<i>Activity/Service Name</i>	<i>Activities/Services Provided</i>
Send Phasor Measurement	Real-time transmission of Phasor Measurement data
Receive Phasor Data	Real time receipt of phasor Measurement data
Aggregate Synchronized Phasors	Upon receiving synchronized phasors from multiple sites, the received phasors are sorted by time tag and passed onto the analysis and feedback control algorithms
Coordinate Global Control	Based on the received phasor measurements and various control algorithms to coordinate the RFCController, VSCController and the SMESDevice controller.
Generator Voltage Control	A control signal (analog or digital) that is sent to the generator voltage regulator in order to modulate the generator voltage to minimize any inter-area oscillations
FACTSDevice Control	A control signal sent from VSCController to change the reactance of the FACTSDevice system

<i>Activity/Service Name</i>	<i>Activities/Services Provided</i>
SMESDevice Control	Control the charging and discharging of the SMESDevice system.

1.8 Contracts/Regulations

Identify any overall (human-initiated) contracts, regulations, policies, financial considerations, engineering constraints, pollution constraints, and other environmental quality issues that affect the design and requirements of the Function.

<i>Contract/Regulation</i>	<i>Impact of Contract/Regulation on Function</i>
PhasorMeasurementContract	

<i>Policy</i>	<i>From Actor</i>	<i>May</i>	<i>Shall Not</i>	<i>Shall</i>	<i>Description (verb)</i>	<i>To Actor</i>
PhasorMeasurementPolicy	PhasorMeasurementUnit			X	Comply with IEEE C37.118 standard	RFController, VSCController

<i>Constraint</i>	<i>Type</i>	<i>Description</i>	<i>Applies to</i>

2 Step by Step Analysis of Function

Describe steps that implement the function. If there is more than one set of steps that are relevant, make a copy of the following section grouping (Preconditions and Assumptions, Steps normal sequence, and Steps alternate or exceptional sequence, Post conditions)

2.1 Steps to implement function

Name of this sequence.

2.1.1 Preconditions and Assumptions

Describe conditions that must exist prior to the initiation of the Function, such as prior state of the actors and activities

Identify any assumptions, such as what systems already exist, what contractual relations exist, and what configurations of systems are probably in place

Identify any initial states of information exchanged in the steps in the next section. For example, if a purchase order is exchanged in an activity, its precondition to the activity might be 'filled in but unapproved'.

<i>Actor/System/Information/Contract</i>	<i>Preconditions or Assumptions</i>
Phasor Measurement Unit	Must have voltage (3-phase) and time synchronization in order to compute phasors
Remote Function Controller	Must have valid communications from the remote sites; the controlled generator must be up and running

2.1.2 Steps – Normal Sequence

Describe the normal sequence of events, focusing on steps that identify new types of information or new information exchanges or new interface issues to address. Should the sequence require detailed steps that are also used by other functions, consider creating a new “sub” function, then referring to that “subroutine” in this function. Remember that the focus should be less on the algorithms of the applications and more on the interactions and information flows between “entities”, e.g. people, systems, applications, data bases, etc. There should be a direct link between the narrative and these steps.

The numbering of the sequence steps conveys the order and concurrency and iteration of the steps occur. Using a Dewey Decimal scheme, each level of nested procedure call is separated by a dot ‘.’. Within a level, the sequence number comprises an optional letter and an integer number. The letter specifies a concurrent sequence within the next higher level; all letter sequences are concurrent with other letter sequences. The number specifies the sequencing of messages in a given letter sequence. The absence of a letter is treated as a default 'main sequence' in parallel with the lettered sequences.

Sequence 1:

*1.1 - Do step 1
1.2A.1 - In parallel to activity 2 B do step 1
1.2A.2 - In parallel to activity 2 B do step 2
1.2B.1 - In parallel to activity 2 A do step 1
1.2B.2 - In parallel to activity 2 A do step 2
1.3 - Do step 3
1.3.1 - nested step 3.1
1.3.2 - nested step 3.2*

Sequence 2:

*2.1 - Do step 1
2.2 - Do step 2*

#	Event	Primary Actor	Name of Process/Activity	Description of Process/Activity	Information Producer	Information Receiver	Name of Info Exchanged	Additional Notes	IECSA Environments
#	<i>Triggering event? Identify the name of the event.¹</i>	<i>What other actors are primarily responsible for the Process/Activity? Actors are defined in section 1.5.</i>	<i>Label that would appear in a process diagram. Use action verbs when naming activity.</i>	<i>Describe the actions that take place in active and present tense. The step should be a descriptive noun/verb phrase that portrays an outline summary of the step. "If ...Then...Else" scenarios can be captured as multiple Actions or as separate steps.</i>	<i>What other actors are primarily responsible for Producing the information? Actors are defined in section 1.5.</i>	<i>What other actors are primarily responsible for Receiving the information? Actors are defined in section 1.5. (Note – May leave blank if same as Primary Actor)</i>	<i>Name of the information object. Information objects are defined in section 1.6</i>	<i>Elaborate architectural issues using attached spreadsheet. Use this column to elaborate details that aren't captured in the spreadsheet.</i>	<i>Reference the applicable IECSA Environment containing this data exchange. Only one environment per step.</i>
1.1	Any power system state	Phasor Measurement Unit	Send Phasor Measurement	At all times, the PMUs in the field shall synchronously send phasors to the RFC Controller and VSC Controller.	Phasor Measurement Unit	RF Controller, VSC Controller	Synchro Phasor	Synchro phasors must be received at a rate of up to 60 phasors per second. Security is not crucial, however, data integrity is paramount, i.e., no faulty data shall be accepted.	Intra-Control Center

¹ Note – A triggering event is not necessary if the completion of the prior step – leads to the transition of the following step.

#	Event	Primary Actor	Name of Process/Activity	Description of Process/Activity	Information Producer	Information Receiver	Name of Info Exchanged	Additional Notes	IECSA Environments
1.2	Power system disturbance (e.g. fault)	RFCController and VSCController	Coordinate Global Control	PMUs continue to send phasor data. Upon detection of $df/dt > \epsilon$, trigger a storage local storage event; RFCs continue to synchronously receive phasor data and also detect the system event; The RFCController/VSCs, upon detection of the event, will trigger local data storage and coordinate the control action in order to coneract the detected inter-area oscillations.				The communication requirements differ from algorithm to algorithm. For the decentralized control, the system is decoupled with known system states.	NA
1.3 A	New control calculate	RFCController	Generator Voltage Control	The RFCController, having detected an inter-area oscillation and having computed an appropriate control action, sends the control information to the voltage regulator	RFCController	AVRController	Controller Settings	Voltage regulator control information shall be issued at the same rate as the synchro voltage receive rate	Intra-Control Center

#	Event	Primary Actor	Name of Process/Activity	Description of Process/Activity	Information Producer	Information Receiver	Name of Info Exchanged	Additional Notes	IECSA Environments
1.3 B	New control calculate	VSCController	FACTSDevice Control	The VSCController, having detected an inter-area oscillation and having computed an appropriate control action, sends the control information to the FACTSDevice system	VSCController	FACTSDevice	Controller Settings		Deterministic Rapid Response Intra-Sub
1.3 C	New control calculate	SMESDevice SMESController	SMESDevice Control	The SMESDeviceSMESController, having detected an inter-area oscillation and having computed an appropriate control action, sends the control information to the FACTSDevice system	SMESDevice SMESController	SMESDevice	Controller Settings		Deterministic Rapid Response Intra-Sub

2.1.3 Steps – Alternative / Exception Sequences

Describe any alternative or exception sequences that may be required that deviate from the normal course of activities. Note instructions are found in previous table.

#	Event	Primary Actor	Name of Process/Activity	Description of Process/Activity	Information Producer	Information Receiver	Name of Info Exchanged	Additional Notes	IECSA Environments

2.1.4 Post-conditions and Significant Results

Describe conditions that must exist at the conclusion of the Function. Identify significant items similar to that in the preconditions section.

Describe any significant results from the Function

<i>Actor/Activity</i>	<i>Post-conditions Description and Results</i>

2.2 Architectural Issues in Interactions

Elaborate on all architectural issues in each of the steps outlined in each of the sequences above. Reference the Step by number.



Microsoft Excel
Worksheet

2.3 Diagram

For clarification, draw (by hand, by Power Point, by UML diagram) the interactions, identifying the Steps where possible.

3 Auxiliary Issues

3.1 References and contacts

Documents and individuals or organizations used as background to the function described; other functions referenced by this function, or acting as “sub” functions; or other documentation that clarifies the requirements or activities described. All prior work (intellectual property of the company or individual) or proprietary (non-publicly available) work must be so noted.

ID	Title or contact	Reference or contact information
[1]	Inter-area oscillation damping with power system stabilizers and synchronized phasor measurements	Snyder, A.F.; Hadjsaid, N.; Georges, D.; Mili, L.; Phadke, A.G; Faucon, O.; Vitet, S.; Power System Technology, 1998. Proceedings, POWERCON'98. 1998 International Conference on, Volume: 2, 18-21 Aug. 1998 Pages: 790 – 794 Vol.2
[2]	A fundamental study of inter-area oscillations in power systems	Klein, M.; Rogers G.J.; Kundur P.; Power Systems, IEEE Transactions on, Volume: 6, Issue: 3, Aug. 1991 Pages: 914 - 921
[3]	Coordinated Decentralized Optimal Control of Inter-Area Oscillations in Power Systems	Lie, T.T.; Li, G.J.; Shrestha, G.B.; Lo, K.L.; Energy Management and Power Delivery, 1998, Proceedings of

		EMPD'98, 1998 International
[4]	Using global control and SMESDevice to damp inter-area oscillations: an exploratory assessment	Heniche, A.; Kamwa, I.; Power Engineering Society Summer Meeting, 2000, IEEE, Volume: 3, 16-20 July 2000 Pages: 1872-1876 vol. 3
[5]	IEEE C37.118 Standard for Synchrophasors for Power Systems	Draft 3.20, Nov 9, 2003

3.2 Action Item List

As the function is developed, identify issues that still need clarification, resolution, or other notice taken of them. This can act as an Action Item list.

ID	Description	Status
[1]		
[2]		

3.3 Revision History

For reference and tracking purposes, indicate who worked on describing this function, and what aspect they undertook.

No	Date	Author	Description
0.	10/29/2003	Mark Adamiak	Complete the draft based on domain template version 1.21
1.	1/20/2004	Rui Zhou	Migrate the draft to domain template version 1.28

System-wide Automatic Voltage Control

1 Descriptions of Function

All prior work (intellectual property of the company or individual) or proprietary (non-publicly available) work should be so noted.

1.1 Function Name

System-wide Automatic Voltage Control (SAVC)

1.2 Function ID

T-5.3, T-1.5.1, T-4.18, T-4.20, T-6.3, T-6.21

1.3 Brief Description

Perform wide-area voltage control through closed loop control by measuring the wide area voltages, computing a control solution, and effecting wide area control

1.4 Narrative

System wide voltage and subsequent power flow can be optimized by looking at the voltage profile for a large segment of the power grid, choosing set-points for the voltages at the various control points, and issuing the appropriate control commands to effect the desired operating point.

Prior to starting the voltage control process, the system would need to determine the availability (in/out of service) and capacity of all the control points around the system. This information would then have to be factored into the voltage control algorithm. For example, if part of a series capacitor bank is out of service, the remaining available series impedance shall be reported; if an SVC is out of service, this shall be reported to the Controller.

Voltage (phase and sequence) from 10 to a few hundred points around the power system are to be measured and transmitted to one or more Controllers located around the power system. Each Controller analyzes the measured voltages and computes an optimal voltage control solution. The control solution would include linear control of generator voltage and synchronous condenser outputs, transformer tap changer control, voltage regulator control, Thyristor controlled Series Capacitor (TCSC) control, Static Var Capacitor control, DC link power flows, as well as

on/off control of series and shunt capacitor banks and reactor switching. A measure/control link to DER/ADA/Consumer/Industrial devices is also envisioned that would enable some voltage support/load shed (in emergency conditions) from the distribution system. Upon issuance of the control command, the device receiving the command shall acknowledge that the voltage control command was received and subsequently executed.

This devices in this scenario would also be used for Voltage Security (see Voltage Security use case) and the steps for Voltage Security are called out as an alternate sequence in the function steps.

On failure of the communication system to a particular node, that node shall resort to local voltage control with previously calculated set-points. Failure of communication to any remote node shall be immediately (within 1 second) to the system operator and other monitoring points as desirable.

1.5 Actor (Stakeholder) Roles

Describe all the people (their job), systems, databases, organizations, and devices involved in or affected by the Function (e.g. operators, system administrators, technicians, end users, service personnel, executives, SCADA system, real-time database, RTO, RTU, IED, power system). Typically, these actors are logically grouped by organization or functional boundaries or just for collaboration purpose of this use case. We need to identify these groupings and their relevant roles and understand the constituency. The same actor could play different roles in different Functions, but only one role in one Function. If the same actor(e.g. the same person) does play multiple roles in one Function, list these different actor-roles as separate rows.

<i>Grouping (Community)</i>		<i>Group Description</i>
<i>Actor Name</i>	<i>Actor Type (person, device, system etc.)</i>	<i>Actor Description</i>
PhasorMeasurementUnit	Device	Source of synchronized data in the substation. Sends measurements to the PhasorDataConcentrator
PhasorDataConcentrator	Device/System	Data collection, organization, and output communication engine. The PhasorDataConcentrator is responsible for establishing bi-directional communications with multiple PMUs. On receiving data, the PhasorDataConcentrator collects the continuous stream of time-stamped data

<i>Grouping (Community)</i>		<i>Group Description</i>
<i>Actor Name</i>	<i>Actor Type (person, device, system etc.)</i>	<i>Actor Description</i>
		from the PMUs, organizes the data by time stamp, and passes the organized data to a Controller and to a data archive database.
Controller	Device/System	Takes measurements from the power system, detects any system abnormalities, computes control actions, issues control commands back to the Controller
CapacitorController	Device	Responds to on/off commands from the Controller and reports status information, power system measurements, and alarms back to the Controller
LoadTapChangeController	Device	Responds to set point commands from the Controller and reports status information (tap position), power system measurements, and alarms back to the Controller
ReactorController	Device	Responds to on/off commands from the Controller and reports status information, power system measurements, and alarms back to the Controller
VoltageRegulatorController	Device	Responds to set point commands from the Controller and reports status information, power system measurements, and alarms back to the Controller
FACTSController	Device	Responds to linear control values from the Controller and operates the FACTS system based on the commanded set point. Communicates operating point, power system measured values, and alarm conditions back to the Controller.
DERDevice	Device	Distributed energy devices located throughout the distribution system that is a source of Volt/Var support.
DistributionVoltVarController	Device	Source of volt/var control in the distribution network

<i>Grouping (Community)</i>		<i>Group Description</i>
<i>Actor Name</i>	<i>Actor Type (person, device, system etc.)</i>	<i>Actor Description</i>
CustomerCommunicationPortal	Devices/System	Source of sheddable load for emergency voltage control applications
VoltageSecurityController	System	Program that detects voltage security issues and calculates the proper Voltage Security control action
ControllableDevice	Devices	Ensemble of devices as (listed above) that can respond to control actions as deemed by the Controller
Regional System Operator	Person	Individual who interfaces with the system and makes decisions as to what non-automatic control actions to take in a given situation
User Interface	Device/System	HMI that runs numerous user applications to view/analyze trends, angles, oscillations, etc.

Replicate this table for each logic group.

1.6 Information exchanged

Describe any information exchanged in this template.

<i>Information Object Name</i>	<i>Information Object Description</i>
PMU Phasor Data	Time Tagged Phasor Measurement data stream from the PMU
Control Information	Substation control information either from the Controller or operator action
Aggregate Data Stream	Output of Phasor Data Concentrator - consolidated stream of phasor data from multiple PMUs

<i>Information Object Name</i>	<i>Information Object Description</i>
PMU Configuration Data	Settings for operation of the PMU

1.7 Activities/Services

Describe or list the activities and services involved in this Function (in the context of this Function). An activity or service can be provided by a computer system, a set of applications, or manual procedures. These activities/services should be described at an appropriate level, with the understanding that sub-activities and services should be described if they are important for operational issues, automation needs, and implementation reasons. Other sub-activities/services could be left for later analysis.

<i>Activity/Service Name</i>	<i>Activities/Services Provided</i>
Stream Phasors	Send a stream of information from the Phasor Measurement Unit
Receive Stream	Receive multiple streams of information from multiple PMUs
Send Control	Control signals sent to PMU devices

1.8 Contracts/Regulations

Identify any overall (human-initiated) contracts, regulations, policies, financial considerations, engineering constraints, pollution constraints, and other environmental quality issues that affect the design and requirements of the Function.

<i>Contract/Regulation</i>	<i>Impact of Contract/Regulation on Function</i>

<i>Policy</i>	<i>From Actor</i>	<i>May</i>	<i>Shall Not</i>	<i>Shall</i>	<i>Description (verb)</i>	<i>To Actor</i>
SecurityPolicy	PHASORMEASUREMENTUNIT			X	Provide security on data transmitted across any utility boundaries	PhasorDataConcentrator
SecurityPolicy	PhasorDataConcentrator			X	Provide security on data transferred between PDCs	PhasorDataConcentrator
SecurityPolicy	Controller			X	Provide security on control data	ControllableDevice
Authentication Policy	Controller			X	Provide authentication on control data to the controlled devices	ControllableDevice

<i>Constraint</i>	<i>Type</i>	<i>Description</i>	<i>Applies to</i>

2 Step by Step Analysis of Function

Describe steps that implement the function. If there is more than one set of steps that are relevant, make a copy of the following section grouping (Preconditions and Assumptions, Steps normal sequence, and Steps alternate or exceptional sequence, Post conditions)

2.1 Steps to implement function

Name of this sequence.

2.1.1 Preconditions and Assumptions

Describe conditions that must exist prior to the initiation of the Function, such as prior state of the actors and activities

Identify any assumptions, such as what systems already exist, what contractual relations exist, and what configurations of systems are probably in place

Identify any initial states of information exchanged in the steps in the next section. For example, if a purchase order is exchanged in an activity, its precondition to the activity might be 'filled in but unapproved'.

<i>Actor/System/Information/Contract</i>	<i>Preconditions or Assumptions</i>
Controller	Set initial desired voltage state
Controller	Determine if a control device is available to be controlled
PHASORMEASUREMENTUNIT	Report initial system voltage state
Controller	Set initial control state

2.1.2 Steps – Normal Sequence

Describe the normal sequence of events, focusing on steps that identify new types of information or new information exchanges or new interface issues to address. Should the sequence require detailed steps that are also used by other functions, consider creating a new “sub” function, then referring to that “subroutine” in this function. Remember that the focus should be less on the algorithms of the applications and more on the interactions and information flows between “entities”, e.g. people, systems, applications, data bases, etc. There should be a direct link between the narrative and these steps.

The numbering of the sequence steps conveys the order and concurrency and iteration of the steps occur. Using a Dewey Decimal scheme, each level of nested procedure call is separated by a dot ‘.’. Within a level, the sequence number comprises an optional letter and an integer number. The letter specifies a concurrent sequence within the next higher level; all letter sequences are concurrent with other letter sequences. The number specifies the sequencing of messages in a given letter sequence. The absence of a letter is treated as a default 'main sequence' in parallel with the lettered sequences.

Sequence 1:

*1.1 - Do step 1
1.2A.1 - In parallel to activity 2 B do step 1
1.2A.2 - In parallel to activity 2 B do step 2
1.2B.1 - In parallel to activity 2 A do step 1
1.2B.2 - In parallel to activity 2 A do step 2
1.3 - Do step 3
1.3.1 - nested step 3.1
1.3.2 - nested step 3.2*

Sequence 2:

*2.1 - Do step 1
2.2 - Do step 2*

#	Event	Primary Actor	Name of Process/Activity	Description of Process/Activity	Information Producer	Information Receiver	Name of Info Exchanged	Additional Notes	IECSA Environments
#	<i>Triggering event? Identify the name of the event.¹</i>	<i>What other actors are primarily responsible for the Process/Activity? Actors are defined in section 1.5.</i>	<i>Label that would appear in a process diagram. Use action verbs when naming activity.</i>	<i>Describe the actions that take place in active and present tense. The step should be a descriptive noun/verb phrase that portrays an outline summary of the step. "If ...Then...Else" scenarios can be captured as multiple Actions or as separate steps.</i>	<i>What other actors are primarily responsible for Producing the information? Actors are defined in section 1.5.</i>	<i>What other actors are primarily responsible for Receiving the information? Actors are defined in section 1.5. (Note – May leave blank if same as Primary Actor)</i>	<i>Name of the information object. Information objects are defined in section 1.6</i>	<i>Elaborate architectural issues using attached spreadsheet. Use this column to elaborate details that aren't captured in the spreadsheet.</i>	<i>Reference the applicable IECSA Environment containing this data exchange. Only one environment per step.</i>
1.1	System Initialization	System Regional System Operator	Initialization	System operator starts the automatic voltage control process	Controller	Controllable Device	Initialization data; configuration data		Lower Security DAC
1.2	Programmed data rate	PHASOR MEASUREMENT UNIT	Measure System Voltage	Measure system voltage and stream to PhasorData Concentrator	PHASOR MEASUREMENT UNIT	PhasorData Concentrator	Phasor Data stream		Inter-Field Equipment
1.3	Programmed data rate	PhasorData Concentrator	Aggregation	Aggregate phasor data streams from multiple PHASOR MEASUREMENT UNIT sources	PhasorData Concentrator	Controller	Aggregated Phasor Data		Lower Security DAC
1.4	Programmed data rate	Controller	Decision	Manipulation of phasor data to determine the control required to implement the optimal system voltage	Controller	Controllable Device	Control information		Lower Security DAC

¹ Note – A triggering event is not necessary if the completion of the prior step – leads to the transition of the following step.

#	Event	Primary Actor	Name of Process/Activity	Description of Process/Activity	Information Producer	Information Receiver	Name of Info Exchanged	Additional Notes	IECSA Environments
1.5	Programmed data rate	Controllable Device	Acknowledge	Acknowledge that the ControllableDevice received the control command and were able to execute as requested	ControllableD evice	Controller	Status information		Lower Security DAC

2.1.3 Steps – Alternative / Exception Sequences

Describe any alternative or exception sequences that may be required that deviate from the normal course of activities. Note instructions are found in previous table.

#	Event	Primary Actor	Name of Process/Activity	Description of Process/Activity	Information Producer	Information Receiver	Name of Info Exchanged	Additional Notes	IECSA Environments
2.1	Large system voltage angle detected	Controller	Angle Check	Check the difference of the angles of the voltages across the system	Controller	Regional System Operator; VoltageSecurityController	Voltage Security alarm; Voltage angle difference		Lower Security DAC
2.2	Large system voltage angle detected	Controller	Voltage Security Control	Determine the corrective action to be taken upon detection of a voltage security issue	VoltageSecurityController	Controller	System phase angles		Lower Security DAC

#	Event	Primary Actor	Name of Process/Activity	Description of Process/Activity	Information Producer	Information Receiver	Name of Info Exchanged	Additional Notes	IECSA Environments
2.3	Large system voltage angle detected	Controller	Issue Control Action	Issue the control actions to the controllable elements around the system	Controller	Controllable Device	Control		Lower Security DAC
2.4	Control action received	Controllable Device	Acknowledge	Acknowledgement that the control action has been received and executed	Controllable Device	Controller	Control Acknowledge		Lower Security DAC

2.1.4 Post-conditions and Significant Results

Describe conditions that must exist at the conclusion of the Function. Identify significant items similar to that in the preconditions section.

Describe any significant results from the Function

<i>Actor/Activity</i>	<i>Post-conditions Description and Results</i>

2.2 Architectural Issues in Interactions

Elaborate on all architectural issues in each of the steps outlined in each of the sequences above. Reference the Step by number.



Microsoft Excel
Worksheet

[1]	<u>Future Trends in Power System Control</u>	Computer Applications in Power; July 2002; Bruce Fardanesh
[2]	Bruce Fardanesh	NYPA
[3]	Voltage Security Use Case	

3.2 Action Item List

As the function is developed, identify issues that still need clarification, resolution, or other notice taken of them. This can act as an Action Item list.

ID	Description	Status
[1]		
[2]		

3.3 Revision History

For reference and tracking purposes, indicate who worked on describing this function, and what aspect they undertook.

No	Date	Author	Description
0.	12/11/03	Adamiak	Initial engagement with Bruce Fardanesh - NYPA

Wide Area Control System for the Self-healing Grid (SHG)

1 Descriptions of Function

All prior work (intellectual property of the company or individual) or proprietary (non-publicly available) work should be so noted.

1.1 Function Name

Wide-Area Control System for the Self-healing Grid (SHG)

1.2 Function ID

IECSA identification number of the function

T-4,T-4.1,T-4.2,T-4.3,T-4.12,T-4.14,T-4.15,T-4.17,T-4.18,T-4.19,T-4.20,T-4.21,T-4.22,T-5,T-6,T-6.5,T-6.10,T-6.11,T-6.17,T-6.18,T-6.19,T-6.21

1.3 Brief Description

Describe briefly the scope, objectives, and rationale of the Function.

The objective of the SHG applications is to evaluate power system behavior in real-time, prepare the power system for withstanding credible combinations of contingencies, prevent wide-area blackouts, and accommodate fast recovery from emergency state to normal state.

1.4 Narrative

A complete narrative of the Function from a Domain Expert's point of view, describing what occurs when, why, how, and under what conditions. This will be a separate document, but will act as the basis for identifying the Steps in Section 2.

The SHG function comprises a set of computing applications for information gathering, modeling, decision-making, and controlling actions. These applications reside in central and/or in widely distributed systems, such as relay protection, remedial automation schemes (RAS), local controllers, and other distributed intelligence systems. All these applications and system components operate in a coordinated manner and are adaptive to the actual situations.

The conventional methodology for emergency control is based on off-line studies for selection of the local emergency automation schemes, their locations, and their settings. Such off-line studies are usually performed for selected operating conditions based on typical cases and on previous emergencies. However, the design of remedial actions and emergency automation schemes based on previous emergencies may be ineffective for the future emergencies. In reality, the emergency situations often occur under conditions that are quite different from the study cases. With the advent of deregulation, the energy schedules are derived from financial considerations rather than strictly power operations considerations. Therefore, the types of possible contingencies increase substantially, and it would be very difficult to study with purely off-line analyses. Not only are there increased pressures from deregulation, there are new challenges imposed by the involvement of distribution systems and customers in preventing and responding to power system emergencies. For instance, with the increased number of distributed energy resource (DER) devices connected to the distribution system, distribution operations have to expand to monitor and manage (if not actually control) these DER devices. The advances of Distribution Management Systems (DMS) and Advanced Distribution Automation (ADA) make these systems available for real-time coordination of transmission and distribution operations in normal, emergency, and restorative states of the power systems.

The SHG will be supported by fast data acquisition systems (WIDE AREA MEASUREMENT SYSTEM(S)/SCADA) and will include fast simulation and decision-making applications observing wide power system areas. These wide-area applications will coordinate the behavior of distributed control systems (regional EMS, DMS, Plant EMS, RAS, and relay protection). These distributed systems and actuators will perform adequately fast under emergency and later under restorative conditions following the rules and settings preset by the upper level simulation and decision-making applications. The coordination of different systems and actuators will be accomplished in a hierarchical manner. Some directive from the upper level, e.g., from the ISO/RTO EMS will be transmitted to the regional EMS, and some commands and settings will be downloaded directly to the actuators. The regional EMS will transmit some directives to the DMS and plant EMS and some commands and settings will be directly downloaded to the actuators, which are in the corresponding areas of responsibility. Some local actuators will be integrated into distributed intelligence schemes and will communicate among themselves in a peer-to-peer manner. The rules of behavior of the distributed intelligence schemes can be preset by the upper control system. (See Fig.1).

The power system operators will be the Persons In Charge (PIC) for the performance of the entire SHG and will participate in the system setup and decision-making processes, which allow sufficient time for the operators to perform an educated action. Under emergency conditions, when fast and complex actions should be performed, the pre-armed and adaptive local and distributed applications and automatic schemes should be the main executors for the protection of equipment and prevention of blackouts.

The future control system for the self-healing grid will differ from the current approaches by implementing significantly more automated controls instead of supervisory controls by the operators and by aiming at preservation of adequate integrity of the generation-transmission-distribution-customer system instead of self-protection of equipment only.

Figure 1 Integration of DMS/ADA with EMS - A real time adaptive decision -making and wide area control system is required to meet the objectives of the self-healing grid.

Coordination of Emergency Actions

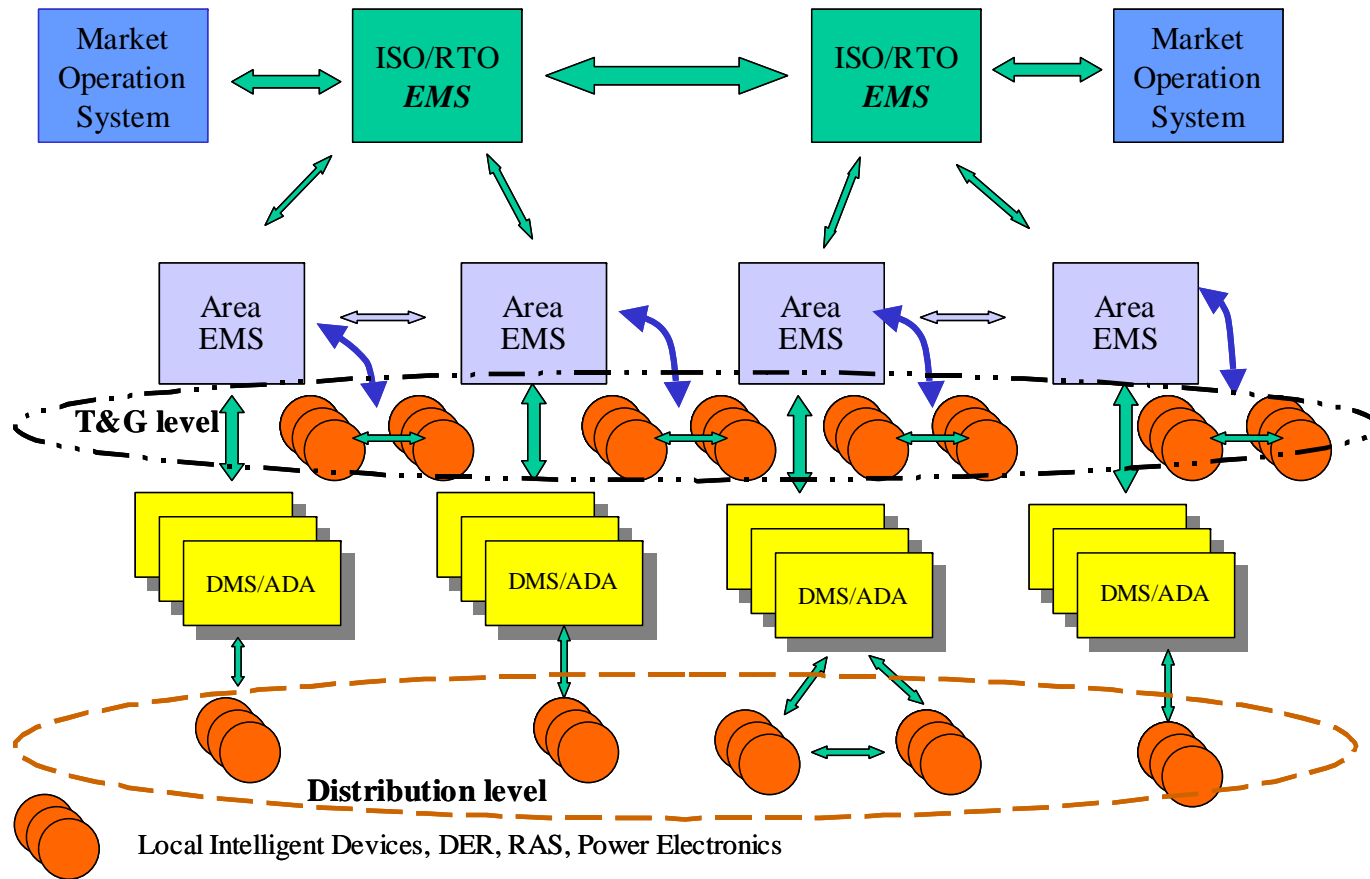

1.5 Actor (Stakeholder) Roles

Describe all the people (their job), systems, databases, organizations, and devices involved in or affected by the Function (e.g. operators, system administrators, technicians, end users, service personnel, executives, SCADA system, real-time database, RTO, RTU, IED, power system). Typically, these actors are logically grouped by organization or functional boundaries or just for collaboration purpose of this use case. We need to identify these groupings and their relevant roles and understand the constituency. The same actor could play different roles in different Functions, but only one role in one Function. If the same actor (e.g. the same person) does play multiple roles in one Function, list these different actor-roles as separate rows.

<i>Grouping (Community)</i>		<i>Group Description</i>
<i>Top Level Stakeholders</i>		<i>High-level actors who have significant stake on the SHG function.</i>
<i>Actor Name</i>	<i>Actor Type (person, device, system etc.)</i>	<i>Actor Description</i>
Regional System Operator	Organization	Organizations responsible for maintaining transmission system reliability and ensuring open access to the grid for all market participants. Regional System Operator responsibilities include: transmission planning, contingency analysis, real-time system operation, and market monitoring and management.
SCADA System	System	Control area supervisory control and data acquisition system
Energy Management System	System	Control area energy management system
Wide Area Measurement System(s)	System	Phasor measurement system covers a wide power system area.
Power Market	Entity	Entities who buy and sell electricity in wholesale markets.

<i>Grouping (Community)</i>		<i>Group Description</i>
<i>Top Level Stakeholders</i>		<i>High-level actors who have significant stake on the SHG function.</i>
<i>Actor Name</i>	<i>Actor Type (person, device, system etc.)</i>	<i>Actor Description</i>
r		
PowerSystem	System	Composition of interconnected transmission, generation, distribution power systems
Reliability/security Coordinator	Entity	Entities that are responsible for the reliability of the power grid and have the authority to fulfill that responsibility within the operating region managed by an Regional System Operator
ControlAreaOperator	Entity	Entities that manually operate and maintain control area facilities and equipment, and execute control orders.
Transmission Level Actuator	System	Power system actuators, which are controlled directly by transmission control area SCADA/EMS
Distribution and PlantControlSystem	System	Distribution management systems, distributed energy resources and generation plant control systems
IED	Device	Intelligent electronic devices including protective relays, RTUs, sensors.

<i>Grouping (Community)'</i>		<i>Group Description</i>
<i>Transmission Level Actuator</i>		<i>Power system actuators, which are controlled directly by transmission control area SCADA/EMS</i>
<i>Actor Name</i>	<i>Actor Type (person, device, system etc.)</i>	<i>Actor Description</i>
FACTSDevice	System	A power electronic based system and other static equipment (such as Static Var Compensator, Thyristor Controlled Series Compensator, STATCOM) that provide control of one or more ac transmission system parameters to enhance controllability and increase power transfer capability.
RAS	Systems/devices	Local or distributed intelligence remedial action schemes acting under emergency operating conditions in accordance with either pre-set or adaptive settings to protect equipment, prevent wide-area blackouts, and restore services.

<i>Grouping (Community)'</i>		<i>Group Description</i>
<i>Distribution and PlantControlSystem</i>		<i>Distribution management systems, distributed energy resources and generation plant control systems.</i>
<i>Actor Name</i>	<i>Actor Type (person, device, system etc.)</i>	<i>Actor Description</i>
DistributionManagementSystem	System	A distribution management system is a suite of application software that supports distribution system operations.
ADA	System	Advanced distribution automation is a multifunctional system that supports remote monitoring, coordination and operation of distribution components by taking full advantage of new capabilities in power electronics, information technology and system simulation.

<i>Grouping (Community)'</i>		<i>Group Description</i>
<i>Distribution and PlantControlSystem</i>		<i>Distribution management systems, distributed energy resources and generation plant control systems.</i>
<i>Actor Name</i>	<i>Actor Type (person, device, system etc.)</i>	<i>Actor Description</i>
DERDevice	Device/System	Distributed energy resource refers to distributed generation, storage, load management, combined heat and power and other sources involved in electricity supply, both in stand-alone and interconnection applications.
PlantControlSystem	System	A DCS (distributed control system) that operates a generation plant

<i>Grouping (Community)'</i>		<i>Group Description</i>
<i>IED</i>		<i>Intelligent electronic devices including protective relays, RTUs, sensors.</i>
<i>Actor Name</i>	<i>Actor Type (person, device, system etc.)</i>	<i>Actor Description</i>
ProtectiveRelay	Device	A device that responds to faults by tripping a breaker according to control logic, based on the monitoring of current and voltage values, and on communications with other protective relays.
PhasorMeasurementUnit	Device	Phasor Measurement Unit – a generic device which produces synchronized phasors from voltage and/or current inputs and synchronizing signals.
RemoteTerminalUnit	Device	Remote Terminal Unit – A device used to control/monitor/record sensor results in SCADA applications

Replicate this table for each logic group.

1.6 Information exchanged

Describe any information exchanged in this template.

<i>Information Object Name</i>	<i>Information Object Description</i>
Real Time Data	Information needed to be updated or exchanged in real time. These data include voltage, current phasor measurements, and frequency, rate of change of frequency, rate of change of voltage calculations. The system flow (both MW and MVAR) can be derived by the voltage and current phasors.
Control Area Network Model	<p>One could partition the power system network model used by a control area into four subnetworks as follows: [1]</p> <p>Subnetwork 1. Internal transmission network is modeled in detail and it is monitored.</p> <p>Subnetwork 2. Unmonitored internal transmission network is modeled in detail as well. It is expected that the unmonitored internal network will be minimized in time given the growth in the utility communication infrastructure.</p> <p>Subnetwork 3. Adjacent external network is modeled in detail because it has significant impact on the security of the internal system. This model will be updated based on the input from adjacent control center.</p> <p>Subnetwork 4: Distant external network is modeled by reduced equivalents because it has less impact on the internal system.</p>
Control Area Network Model Parameters	The parameters in the control area network model include facility status (such as generation shifts due to changes in transaction schedules, redispatch and unit outages, and the status of power plant auxiliary equipments), transmission element impedances, control device set points (such as generator and LTC settings), generation response capabilities (MW/min), breaker/switch states (these states are critical to update the topology of the control area network), and bus load.
Controller Settings	These settings include relay protection and load shedding schemes, other remedial action schemes (RAS), and set points for FACTSDevice devices, voltage controller, phase-shifters and other controllers.

<i>Information Object Name</i>	<i>Information Object Description</i>
Control Actions	The control actions involve real and reactive power generators, controllable shunts in transmission, FACTSDevice devices, phase shifters, Load Tap Changers (LTCs), transmission sectionalizing, and distribution automation functions like Volt/Var control, feeder reconfiguration, and load management functions.
Transmission System Limits	The transmission system limits include the determination of the thermal limits, available capacity, economic constraints, interface limits, steady state, transient and small signal voltage stability limits.
PowerSystem Vulnerability Data	The power system vulnerability data include fault information, environmental data, and other sources of power system vulnerability data
Boundary Conditions	Refer to the power system conditions such as voltage, current, and phase angles at the boundary of the network model that is used to simulate internal system behavior.

1.7 Activities/Services

Describe or list the activities and services involved in this Function (in the context of this Function). An activity or service can be provided by a computer system, a set of applications, or manual procedures. These activities/services should be described at an appropriate level, with the understanding that sub-activities and services should be described if they are important for operational issues, automation needs, and implementation reasons. Other sub-activities/services could be left for later analysis.

<i>Activity/Service Name</i>	<i>Activities/Services Provided</i>
Dynamic Model Update	EMS system performs dynamic model update, state estimation, bus load forecast. Dynamic Model Update sub-function updates the system model to reflect the status of the transmission and generation equipment and critical operational parameters in real-time, based on gathering the wide-area synchronized phasor measurements and estimating the missing and inaccurate data; The bus-load model update and forecast is supported by the distribution operation model and analysis; In a multi-area interconnected system, each control area updates its model and exchanges the full or reduced model with neighbor areas.
Optimal Power Flow (OPF)	EMS system performs optimal power flow analysis, recommends optimization actions: Optimal Power

<i>Activity/Service Name</i>	<i>Activities/Services Provided</i>
	<p>flow provides operations personnel with recommended system changes to correct limit violations while optimizing the system for pre-defined objectives including minimizing losses, maximizing MW capacity via optimal Mvar control, minimizing the number of controls moved, or minimizing the movement in all available controls. OPF uses bus load models supported by DistributionManagementSystem applications and includes the bus dispatchable load in its variables. OPF issues sets of actions for multiple local controllers, distributed intelligence schemes, and DistributionManagementSystem applications.</p>
Stability Analyses	<p>EMS system performs stability study of network to: Determine the dynamic stability limits and Determine whether network is operating close to limits of stability</p>
Real Time Contingency Analysis	<p>EMS system performs contingency analysis (CA), recommends preventive and corrective actions:</p> <p>Contingency Analysis and post-contingency analysis of remedial action provides the ability to correct problems caused by harmful disturbances</p> <p>Result from contingency analysis is analyzed by post contingency optimal power flow</p> <p>The post contingency optimal power flow simulates the behavior of relay protection, load shedding schemes, other remedial action schemes (RAS), FACTS devices, voltage controllers, phase-shifters, and other local controllers. Status and set points are obtained from the dynamic model update, and are applied to probabilistic models of power system operations.</p> <p>CA sub- function considers multiple sets of independent and dependent contingencies and provides risk assessment and severity evaluation of the sets</p> <p>CA sub-function develops and implements preventive actions to reduce the risk and severity of anticipated contingencies, including generation-constrained optimal power flow implemented in closed-loop mode, blocking of some controls, and pre-arming of RAS and other distributed intelligence schemes.</p> <p>CA checks the success of execution of the preventive actions and changes the input criteria in case of failure.</p>

<i>Activity/Service Name</i>	<i>Activities/Services Provided</i>
	This activity is further elaborated in the “Contingency Analysis” use cases.
Real-time Emergency Operations (system protection level)	<p>Protects power system facilities from damage</p> <p>Automatically sheds load under conditions of low frequency, based on pre-defined or real-time computed settings, modes of operations, and priorities of connected groups of customers. Should be made adaptive to the conditions of the interconnected self-healing grid and non-intentional and intentional islanding.</p> <p>Automatically sheds or reduces generation to preserve load balance over the transmission lines and power system stability</p> <p>Automatically sheds load under conditions of low voltage, based on pre-defined or real-time computed settings, modes of operations, and priorities of connected groups of customers. Should be made adaptive to the conditions of the interconnected self-healing grid and non-intentional and intentional islanding.</p> <p>Automatically sheds load under specific conditions, based on pre-defined or real-time computed settings, modes of operations, and priorities of connected groups of customers. Should be made adaptive to the conditions of the interconnected self-healing grid and non-intentional and intentional islanding.</p> <p>Restores load based on real-time power system restoration capabilities. Should be made adaptive to the changing conditions.</p> <p>Fast control of LTC to prevent voltage instability (Fast = 10 to 100ms – depending on the size of the control area)</p> <p>Fast control of shunts to prevent voltage instability</p> <p>Fast control of series compensation devices to prevent system instability and critical overloads</p> <p>Balanced separation of the power system into near balanced islands to prevent cascading development</p>

<i>Activity/Service Name</i>	<i>Activities/Services Provided</i>
	<p>of severe contingencies into wide-area blackout.</p> <p>Filters and summarizes multiple alarms into a conclusive message about the core cause of the contingency. Uses centralized alarm reduction based on events from multiple substations</p> <p>Automatically locates faults based on high-speed synchronized measurements</p> <p>Provides field crews with real-time information by using mobile computing</p> <p>Provides pre-fault, fault, and post-fault data for fault location, alarm processing, and analyses of the emergency operating conditions.</p> <p>Provides other EMS applications and the operators with near-real time stability limits</p> <p>Changes the modes of operation, the settings, and the priorities of RAS, based on evaluation of the developing or expected emergency conditions.</p> <p>Issues summary requirements to DISCOs for changing distribution operations, based on evaluation of the developing or expected emergency conditions.</p> <p>Changes the modes of operation, the objectives, constraints, and the priorities of DistributionManagementSystem Volt/var control application, based on evaluation of the developing or expected emergency conditions</p> <p>Changes the modes of operation, the objectives, constraints, and the priorities of DistributionManagementSystem feeder reconfiguration application, based on evaluation of the developing or expected emergency conditions</p> <p>Issues summary requirements (amount and timing) to DISCOs for activating the interruptible/curtailable load systems. DISCO defines the specifics of implementation.</p> <p>Issues summary requirements (amount and timing) to DISCOs for activating the direct load control systems. DISCO defines the specifics of implementation.</p>

<i>Activity/Service Name</i>	<i>Activities/Services Provided</i>
	<p>Issues summary requirements (amount and timing) to DISCOs for activating the DERDevice reserves. DISCO defines the specifics of implementation.</p> <p>Issues summary requirements (amount and timing) to DISCOs for activating the load managements systems. DISCO defines the specifics of implementation.</p> <p>This activity is further elaborated in the “Emergency Operation” use cases.</p>
System Restoration	<p>Operators perform system restorations based on system restoration plans prepared (authorized) by operation management. System restoration to normal state, in addition to automatic restoration, if needed.</p> <p>Unit starts, auto-synchronization, load energization, based on the power system recovery capability monitored and coordinated by EMS</p> <p>This activity is further elaborated in the “Advanced Auto Restoration” use case.</p>

1.8 Contracts/Regulations

Identify any overall (human-initiated) contracts, regulations, policies, financial considerations, engineering constraints, pollution constraints, and other environmental quality issues that affect the design and requirements of the Function.

<i>Contract/Regulation</i>	<i>Impact of Contract/Regulation on Function</i>
Data Exchange Contract	

<i>Policy</i>	<i>From Actor</i>	<i>May</i>	<i>Shall Not</i>	<i>Shall</i>	<i>Description (verb)</i>	<i>To Actor</i>
Data Exchange Policy	EnergyManagementSystem			X	Provides data to other control area EMS based upon bilateral agreements, which define the types and amounts of data and the data exchange frequencies. [1]	EnergyManagementSystem

<i>Constraint</i>	<i>Type</i>	<i>Description</i>	<i>Applies to</i>
Economics Constraints		Optimal Power Flow function is subject to the market constraints.	Optimal Power Flow (Activity)

2 Step by Step Analysis of Function

Describe steps that implement the function. If there is more than one set of steps that are relevant, make a copy of the following section grouping (Preconditions and Assumptions, Steps normal sequence, and Steps alternate or exceptional sequence, Post conditions)

2.1 Steps to implement function

Name of this sequence.

SHG

2.1.1 Preconditions and Assumptions

Describe conditions that must exist prior to the initiation of the Function, such as prior state of the actors and activities

Identify any assumptions, such as what systems already exist, what contractual relations exist, and what configurations of systems are probably in place

Identify any initial states of information exchanged in the steps in the next section. For example, if a purchase order is exchanged in an activity, its precondition to the activity might be 'filled in but unapproved'.

<i>Actor/System/Information/Contract</i>	<i>Preconditions or Assumptions</i>
PowerSystem	PowerSystem is under normal operation state.

2.1.2 Steps – Normal Sequence

Describe the normal sequence of events, focusing on steps that identify new types of information or new information exchanges or new interface issues to address. Should the sequence require detailed steps that are also used by other functions, consider creating a new “sub” function, then referring to that “subroutine” in this function. Remember that the focus should be less on the algorithms of the applications and more on the interactions and information flows between “entities”, e.g. people, systems, applications, data bases, etc. There should be a direct link between the narrative and these steps.

The numbering of the sequence steps conveys the order and concurrency and iteration of the steps that occur. Using a Dewey Decimal scheme, each level of nested procedure call is separated by a dot ‘.’. Within a level, the sequence number comprises an optional letter and an integer number. The letter specifies a concurrent sequence within the next higher level; all letter sequences are concurrent with other letter sequences. The number specifies the sequencing of messages in a given letter sequence. The absence of a letter is treated as a default 'main sequence' in parallel with the lettered sequences.

Sequence 1:

*1.1 - Do step 1
1.2A.1 - In parallel to activity 2 B do step 1
1.2A.2 - In parallel to activity 2 B do step 2
1.2B.1 - In parallel to activity 2 A do step 1
1.2B.2 - In parallel to activity 2 A do step 2
1.3 - Do step 3
1.3.1 - nested step 3.1
1.3.2 - nested step 3.2*

Sequence 2:

*2.1 - Do step 1
2.2 - Do step 2*

#	Event	Primary Actor	Name of Process/Activity	Description of Process/Activity	Information Producer	Information Receiver	Name of Info Exchanged	Additional Notes	IECSA Environments
#	<i>Triggering event? Identify the name of the event.¹</i>	<i>What other actors are primarily responsible for the Process/Activity? Actors are defined in section 1.5.</i>	<i>Label that would appear in a process diagram. Use action verbs when naming activity.</i>	<i>Describe the actions that take place in active and present tense. The step should be a descriptive noun/verb phrase that portrays an outline summary of the step. "If...Then...Else" scenarios can be captured as multiple Actions or as separate steps.</i>	<i>What other actors are primarily responsible for Producing the information? Actors are defined in section 1.5.</i>	<i>What other actors are primarily responsible for Receiving the information? Actors are defined in section 1.5. (Note – May leave blank if same as Primary Actor)</i>	<i>Name of the information object. Information objects are defined in section 1.6</i>	<i>Elaborate architectural issues using attached spreadsheet. Use this column to elaborate details that aren't captured in the spreadsheet.</i>	<i>Reference the applicable IECSA Environment containing this data exchange. Only one environment per step.</i>
1.1A		EnergyManagementSystem	Gather model data	Gather the network model parameters in real time, including actual data about the mode of operation and settings of the automated systems and devices.	SCADA System	EnergyManagementSystem	Control Area Network Model Parameters	High amount of data need to be handled. Common data format is an issue. Missing data is another issue. The data exchange could be report- by-change. Synchronization of data is an issue	Intra-Control Center
1.1B		Regional System Operator	Receive phasor measurements	Receive the wide-area synchronized phasor measurements	WIDE AREA MEASUREMENT SYSTEM(S)	Regional System Operator	Real Time Data	Time synchronization is required. C37.118 specifies synchronization in 1ms for some applications, 5ms for others. [2] Real time constraints: Phasor Measurement Unit delivers up to 60/50 measurements within one second in a 60/50 Hz system.	Inter-Control Center

¹ Note – A triggering event is not necessary if the completion of the prior step transitions to the next step.

#	Event	Primary Actor	Name of Process/Activity	Description of Process/Activity	Information Producer	Information Receiver	Name of Info Exchanged	Additional Notes	IECSA Environments
1.2		Regional System Operator	Synchronize data	Synchronizes and estimates the data obtained from SCADA and WIDE AREA MEASUREMENT SYSTEM(S), identifies and corrects inaccurate data, replaces bad and missing data. Incorporates updates of parameters of controllers and control systems and outputs from other automated systems (DistributionManagementSystem, ADA, plant EMS, neighbor area, ISO/ RTO EMS, MOS).	Regional System Operator	Regional System Operator		Regional System Operator through State estimation/Dynamic Model Update Application. The calculation and updates should be complete within 1 second in some cases	Inter-Control Center
2.1		EnergyManagementSystem Real Time Security Analysis Applications	Collect vulnerability data	Collect fault information, environmental data, and other sources of power system vulnerability data.	SCADA System	EnergyManagementSystem	PowerSystem Vulnerability Data	Time-step for real-time security assessment is 1-10sec [3]	Intra-Control Center
2.2		EnergyManagementSystem Real Time Security Analysis Applications	Simulate system behavior	Simulates the reactions of relevant automated systems based on the updated system model.	EnergyManagementSystem	EnergyManagementSystem	Boundary Conditions	In order to achieve timely results, the system configuration should be considered. Whether to conduct the simulation in centralized or distributed fashion will have significant impact on the architecture.	Inter-Control Center

#	Event	Primary Actor	Name of Process/Activity	Description of Process/Activity	Information Producer	Information Receiver	Name of Info Exchanged	Additional Notes	IECSA Environments
2.3A		EnergyManagementSystem Real Time Security Analysis Applications	Conduct steady state analyses	Conduct steady state analyses by applying probabilistic models of power system components.	EnergyManagementSystem	EnergyManagementSystem			Inter-Control Center
2.3B		EnergyManagementSystem Real Time Security Analysis Applications	Conduct dynamic analyses	Conduct dynamic analyses considering multiple sets of independent and dependent contingencies.	EnergyManagementSystem	EnergyManagementSystem			Inter-Control Center
2.4		EnergyManagementSystem Real Time Security Analysis Applications	Update system limits	Define the distances to system limits that will determine the severity of the contingencies.	EnergyManagementSystem	EnergyManagementSystem	Transmission System Limits		Inter-Control Center
2.5A		EnergyManagementSystem Real Time Security Analysis Applications	Assess security risk	Assess the risk associated with each contingency.	EnergyManagementSystem	EnergyManagementSystem			Inter-Control Center
2.5B		Control Area EM Real Time Security Analysis Applications	Assess intentional islands	Assess the feasibility of automatically created islands and determine the root cause of insecurity.	EnergyManagementSystem	EnergyManagementSystem			Inter-Control Center
3.1	Perceived power system condition change based on Sequence 2 assessment results	EnergyManagementSystem with its Real Time Security Analysis Application preemptive control function	Implement preventive actions	Activate the OPF and implements preventive actions	EnergyManagementSystem	Transmission Level Actuator, Distribution and PlantControlSystem, IED	Controller Settings	A huge amount of data needs to be exchanged in real time.	Intra-Control Center

#	Event	Primary Actor	Name of Process/Activity	Description of Process/Activity	Information Producer	Information Receiver	Name of Info Exchanged	Additional Notes	IECSA Environments
3.2A		EnergyManagementSystem with its Real Time Security Analysis Application preemptive control function	Pre-arm actuators	Pre-arm the appropriate actuators with the corrective actions for emergency events.	EnergyManagementSystem	Transmission Level Actuator, Distribution and PlantControlSystem, IED	Controller Settings	A huge amount of data needs to be exchanged in real time.	Intra-Control Center
3.2B		EnergyManagementSystem with its Real Time Security Analysis Application preemptive control function	Impose inhibition of control	Impose the inhibition of control, if the analysis of hypothetical controller failure would yield much more severe consequences than the denial of the control action itself.	EnergyManagementSystem	Transmission Level Actuator	Controller Settings		Intra-Control Center
3.2C		Regional System Operator	Coordinate corrective actions	Coordinate the corrective actions based on acceptable supply-demand balance in prospective islands, weak links between control areas, within control areas, and within islands, contractual agreements and market rules for implementation.	Regional System Operator	PowerMarketer, EnergyManagementSystem	Control Actions	Bi-directional communications among PowerMarketer, Regional System Operator and control area EMS.	RTOs / Market Participants, Inter-Control Center
4.1		EnergyManagementSystem EnergyManagementSystem through Optimal Power Flow application	Power flow optimization actions	Take power flow optimization actions.	EnergyManagementSystem	PowerMarketer, Regional System Operator, EnergyManagementSystem, Transmission Level Actuator, Distribution and PlantControlSystem	Control Actions		Intra-Control Center, RTOs / Market Participants, Inter-Control Center

#	Event	Primary Actor	Name of Process/Activity	Description of Process/Activity	Information Producer	Information Receiver	Name of Info Exchanged	Additional Notes	IECSA Environments
4.2A		EnergyManagementSystem through Preemptive Control function	Verify system status	Verify the execution results in closed-loop control mode	EnergyManagementSystem	Regional System Operator, EnergyManagementSystem, Transmission Level Actuators, Distribution and PlantControlSystem	Real Time Data		Inter-Control Center, Intra-Control Center
4.2B		EnergyManagementSystem through Real-time emergency operations	Detect imbalance	Detect the generation and load imbalance.	EnergyManagementSystem	Regional System Operator, EnergyManagementSystem	Real Time Data	This function should be executed with 10-100sec. [3]	Inter-Control Center
5.1	Power system under emergency state	Regional System Operator	System decomposition	Decompose the power system into approximately self-sufficient islands.	Regional System Operator	EnergyManagementSystem			Inter-Control Center
5.2		Regional System Operator	Control reconfiguration	Coordinate the interrelated control actions and resolve the conflicting control signals by the higher-level controllers.	Regional System Operator,	EnergyManagementSystem			Inter-Control Center
6.1	Power system under emergency state	Regional System Operator	System correction	Implement emergency control actions such as reducing generation or shedding load or both to restore the generation/load balance.	Regional System Operator	Regional System Operator, EnergyManagementSystem, Transmission Level Actuator, Distribution and PlantControlSystem	Control Actions	The control action must be accomplished within 0.1-1.3 seconds. [4]	Inter-Control Center
7.1	Post emergency state	Regional System Operator	Prepare for restoration	Re-synchronize the separated transmission lines (reconnect islands).	EnergyManagementSystem	Regional System Operator	Real Time Data	System restorations based on system restoration plans prepared (authorized) by operation management	Inter-Control Center

#	Event	Primary Actor	Name of Process/Activity	Description of Process/Activity	Information Producer	Information Receiver	Name of Info Exchanged	Additional Notes	IECSA Environments
7.2		Regional System Operator	Restoration	Start reserve/tripped generation, control shunts and analyze the conditions for load restoration, based on generation reserves, reactive power support, and transmission transfer capacity.	Regional System Operator	EnergyManagementSystem		System restorations based on system restoration plans prepared (authorized) by operation management	Inter-Control Center

2.1.3 Steps – Alternative / Exception Sequences

Describe any alternative or exception sequences that may be required that deviate from the normal course of activities. Note instructions are found in previous table.

#	Event	Primary Actor	Name of Process/Activity	Description of Process/Activity	Information Producer	Information Receiver	Name of Info Exchanged	Additional Notes	IECSA Environments

2.1.4 Post-conditions and Significant Results

Describe conditions that must exist at the conclusion of the Function. Identify significant items similar to that in the preconditions section.

Describe any significant results from the Function

<i>Actor/Activity</i>	<i>Post-conditions Description and Results</i>
PowerSystem	Power system is back to normal operation state.

2.2 Architectural Issues in Interactions

Elaborate on all architectural issues in each of the steps outlined in each of the sequences above. Reference the Step by number.



Microsoft Excel
Worksheet

2.3 Diagram

For clarification, draw (by hand, by Power Point, by UML diagram) the interactions, identifying the Steps where possible.

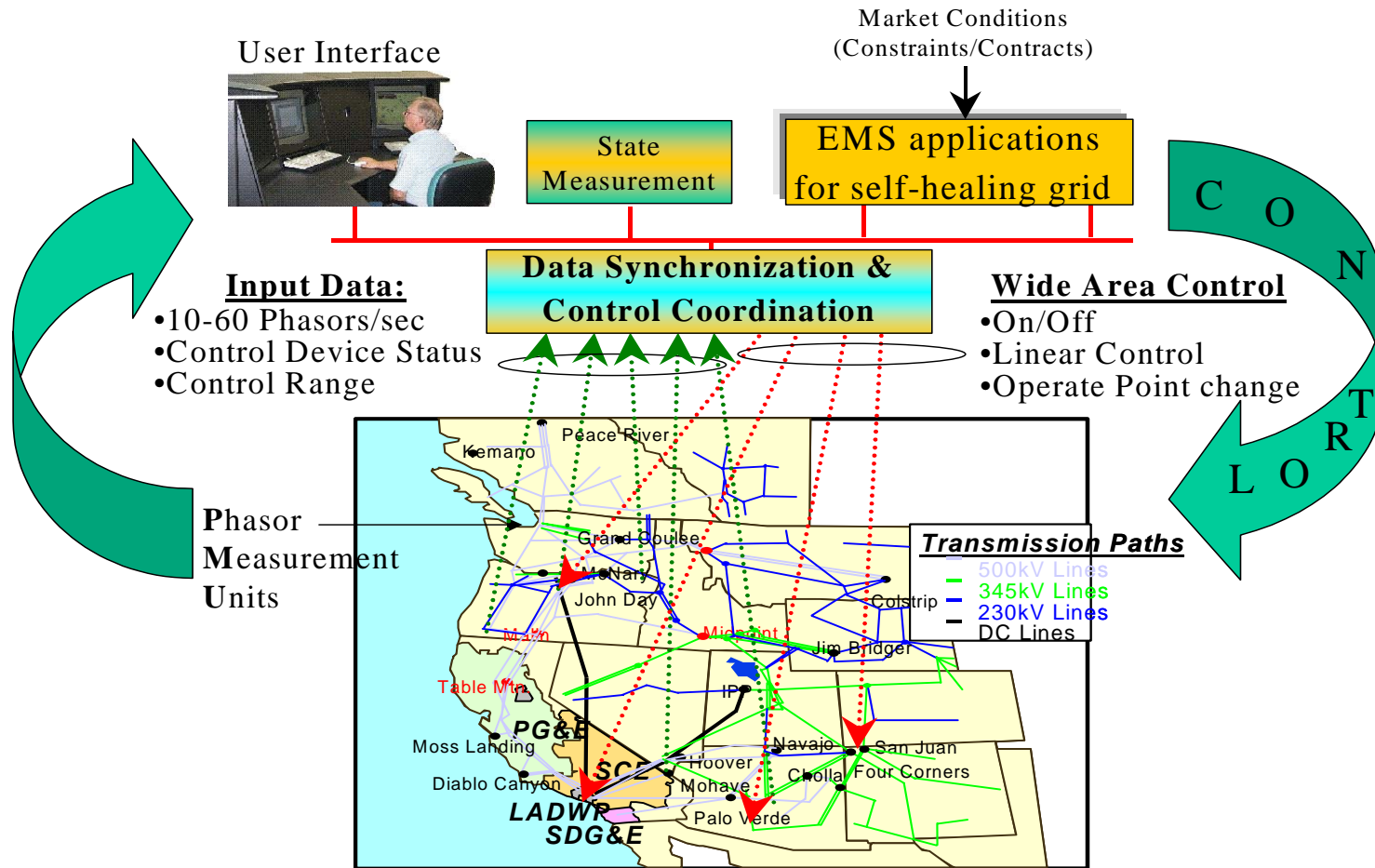

Figure 2 Overview of SHG Application

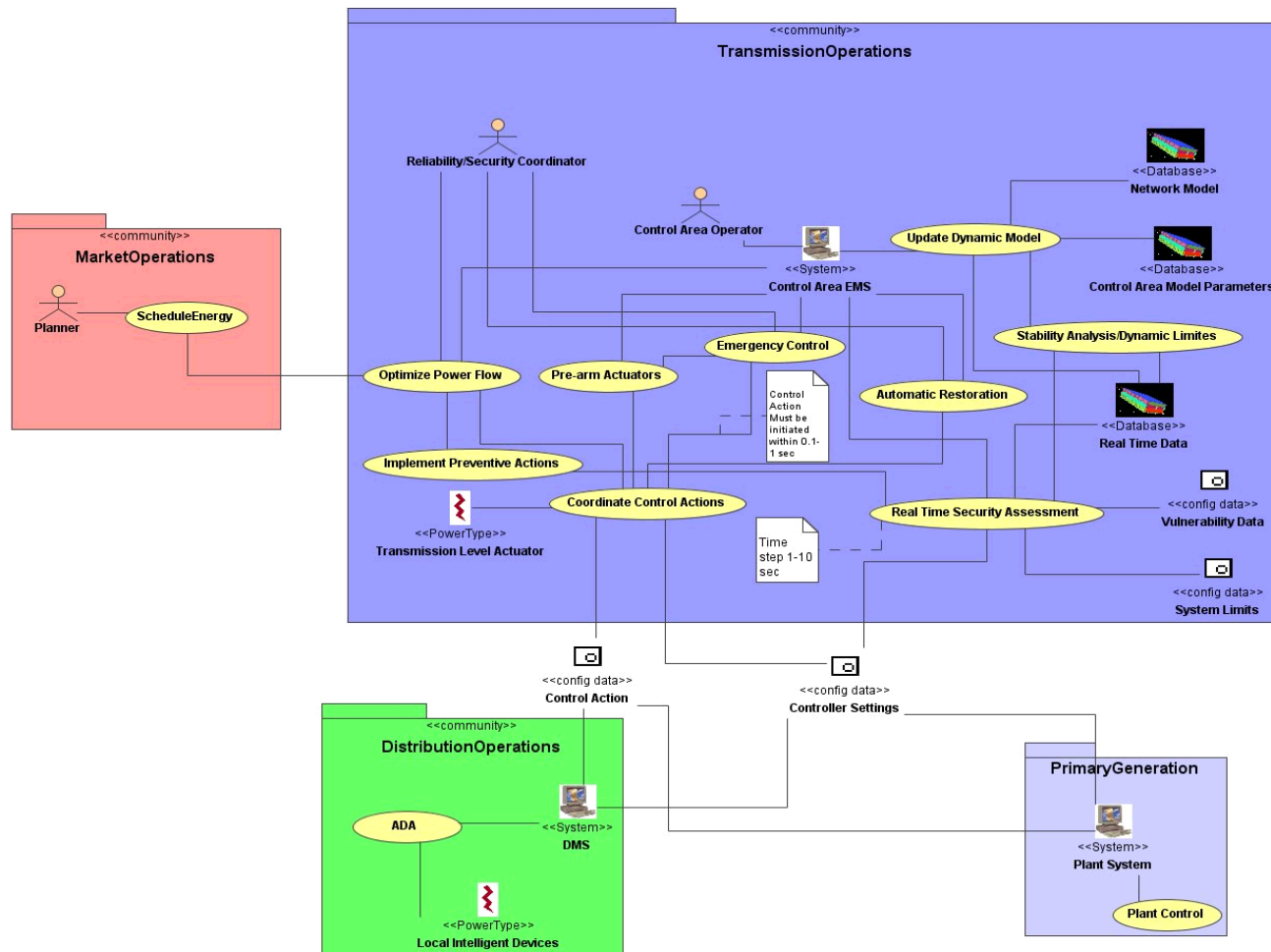

Figure 3 Information Flow Diagram

3 Auxiliary Issues

3.1 References and contacts

Documents and individuals or organizations used as background to the function described; other functions referenced by this function, or acting as “sub” functions; or other documentation that clarifies the requirements or activities described. All prior work (intellectual property of the company or individual) or proprietary (non-publicly available) work must be so noted.

ID	Title or contact	Reference or contact information
[1]	Real-time data exchange for on-line security assessment	K, Kato et.al, Power Industry Computer Application Conference, May 1991, pp30-36
[2]	Syncro Phasor Domain Template	William Premerlani
[3]	Fast Simulation and Modeling System RFP	E2I/CEIDS, Sept 2003
[4]	Adaptive Protection as Preventive and Emergency Control	M.J.Damborg et.al. Power Engineering Society Summer Meeting, 2000. IEEE , Volume: 2 , 16-20 July 2000 Page(s): 1208 -1212 vol. 2
[5]	Specification of integrated SCADA/EMS/DMS for Florida Power and Light (FP&L and UCI proprietary) Experience of System - Wide Distribution Automation At JEA, Don C. Gilbert, Nokhum Markushevich and Alex Fratkin, Distributech 2004 conference The Specifics Of Coordinated Real-Time Voltage And Var Control In Distribution, Nokhum S. Markushevich, Utility Consulting International (UCI), Distributech 2002 Conference	Nokhum Markushevich, (UCI), nokhum@uci-usa.com

	<p>Implementation Of Advanced Distribution Automation In Us Utilities, Nokhum S. Markushevich and Aleksandr P. Berman (Utility Consulting International), Charles J. Jensen (JEA), James C. Clemmer (OG&E), USA, CIRED Conference, Amsterdam, 2001</p> <p>Integration Of Distribution Automation into Power System Operation, Edward H.P. Chan, Nokhum S. Markushevich; DA/DSM Conference, January 1994, Florida</p> <p>Intelligent Alarm Processing, Electric Power Research Institute (EPRI) TR-101576, Research Project #2944-04, E.H.P. Chan, Nokhum Markushevich, and J. Birchfield. December 1992</p> <p>Automated Dispatcher Control System, Nokhum S. Markushevich Moscow, 1986.</p> <p>Under-frequency Load Shedding in Power Systems, Nokhum S. Markushevich, Moscow, 1975.</p>	
--	---	--

3.2 Action Item List

As the function is developed, identify issues that still need clarification, resolution, or other notice taken of them. This can act as an Action Item list.

ID	Description	Status
[1]		
[2]		

3.3 Revision History

For reference and tracking purposes, indicate who worked on describing this function, and what aspect they undertook.

No	Date	Author	Description
0.	10/14/2003	Rui Zhou	Draft the narrative section based on Nokhum's original write-up
1.	10/14/2003	Rui Zhou	Start to fill in the tables and draw the block diagrams
2.	10/15/2003	Nokhum Markushevich	Revised section 1.3 and 1.4
3.	10/16/2003	Rui Zhou	Filled in Section 1.5 and 2.2
4.	10/16/03	Nokhum Markushevich	Rewrote section 1.6 and revised section 2.2
5.	10/16/03	Nokhum Markushevich	Changed 1.6 to a higher level, edited 1.5, changed 2.2, and marked up the use-case diagram
6.	10/27/03	Rui Zhou	Updated based on the domain template ver 1.19
7.	12/16/03	Ellen Liu	Updated based on the latest domain template ver 1.27. Revised section 2.1.2; start working on section 2.2.
8.	12/22/03	Rui Zhou	First cut done for section 2.2; updated 1.6. The document now conforms to the latest version of the domain template.
9	1/30/04	Rui Zhou	Addressed the comments received from the team.
10	1/31/04	Nokhum Markushevich	Added text to 1.4 and an illustration for coordinated emergency operations. Edited and commented on text in other sections.
11	2/26/04	Rui Zhou	Clean up the use case considering the automated importing process.

This page intentionally left blank.

Synchro Phasor

1 Descriptions of Function

All prior work (intellectual property of the company or individual) or proprietary (non-publicly available) work should be so noted.

1.1 Function Name

Synchro-Phasors

1.2 Function ID

IECSA identification number of the function

T-4.3

1.3 Brief Description

This system provides synchronized and time-tagged voltage and current phasor measurements to any protection, control, or monitoring function that requires measurements taken from several locations, whose phase angles are measured against a common, system wide reference. This is an extension of simple phasor measurements, commonly made with respect to a local reference. Present day implementation of many protection, control, or monitoring functions are hobbled by not having access to the phase angles between local and remote measurements. With system wide phase angle information, they can be improved and extended. The essential concept behind this system is the system wide synchronization of measurement sampling clocks to a common time reference.

In addition to providing synchronized measurements, the synchro-phasor system distributes the measurements. Voltages and currents are measured at many nodes throughout the power grid. Any protection, control, or monitoring function can access measurements from several nodes, either by subscribing to continuous streams of data, or requesting snapshots as needed. In principle, any function could request measurements from any node, though in practice most functions require data from only a few nodes.

1.4 Narrative

The following is an example of how synchro-phasors can be used to perform digital current differential fault protection for a two terminal transmission line. There are two intelligent electronic devices, one at each terminal, taking samples of currents from all three phases. Physically, the two terminals might be any distance at all apart, ranging from a few miles to a thousand miles, for example. It is wished to provide fault protection for the transmission line by summing the phasor values of currents to determine differential current. In order to do that, the two intelligent electronic devices need to measure the phasor values against the same time reference, and exchange the data with each other. This can be done with synchro-phasors.

Each intelligent device in this example is both a client and a server of synchro-phasors. As a server, it provides synchro-phasors to its partner. As a client, it requires synchro-phasors from its partner. It is a completely symmetric situation. We will examine the example mostly from the point of view of one of the terminals, call it A.

Terminal A requires a steady stream of phasors for three phase currents from terminal B. In this particular case, it is decided to compute phasors every $\frac{1}{2}$ cycle of the power system frequency, and to transmit them once per $\frac{1}{2}$ cycle. To simplify things, it is decided not to perform frequency tracking, but rather to base the sampling frequency on absolute time. For this particular case, it is decided that synchronization between any pair of measurements must be within 10 microseconds in steady state, even though there are other applications that require tighter synchronization, such as to within 1 microsecond. Transiently, much larger synchronization errors are permitted, but each terminal requires an estimate of the least upper bound of the synchronization error if it exceeds 10 microseconds.

For correct transient tracking, it is decided that the sampling windows must be aligned. That is, the set of sampling times for each phasor window must be the same at each terminal: overlapping is not allowed. It is understood that there may be some latency involved in the exchange of information, but it should not exceed 24 milliseconds, for example. It is also recognized that some data might get lost or corrupted. A certain amount of lost data is acceptable. The amount is somewhat arbitrary, but experience has shown that 2.5% lost data can be tolerated. For this application, it is not necessary to retransmit the lost data, since more, up-to-date data will be arriving shortly anyway. However, it is necessary to inform the protection application, so that it can move on to the next time slot. It is also recognized that sometimes, communications might be down altogether.

The possibility of corrupted data is a fact of life in this arena. Without even considering abnormal events such as electrical interference from faults, many types of communications are considered to be operating normally with a low, but non-zero bit error rate. Unless some steps are taken, it is possible for bit errors to corrupt the data being exchanged. For this application, corrupted data must be detected and ignored, since incorrect data could very well cause a false de-energization of a transmission line, and move one step closer to a black out. Bad data is worse than no data at all. To that end, protection engineers would either want to see a 32 bit cyclic redundancy code protecting against corrupted data, or have some other assurances that under a credible worst scenario, it would not be expected that a corrupted phasor would sneak through more often than once every 300 years.

During installation of the differential protection scheme, the two terminals are identified to each other, and various parameters are selected, including those that impact the exchange of synchro-phasors. There are GPS receivers at both substations that can be used for sampling synchronization, so the intelligent devices are configured to synchronize to the GPS clock. (That is not always the case.) In this case, the GPS receivers are not deemed reliable enough, so a backup strategy is required in which the intelligent devices can synchronize to other clocks in the network using the network time protocol. Also, the system engineers do not completely trust digital communications, so they insist on two physically independent communications channels between the pair of terminals. That way, the system can continue to provide protection if only one of the communications channels fails.

During commissioning, the two intelligent devices are connected to their GPS clocks and checked out. Various tests are run successfully off-line. The devices are then re-initialized in an on-line mode.

During re-initialization of terminal A, the synchro-phasor service synchronizes the local sampling clock to the GPS clock, and turns on the calculation of synchronized phasors. Terminal A then attempts to connect with terminal B, which in this scenario, has not been initialized yet, so terminal A waits. Finally, both terminals are ready, and begin to exchange synchro-phasor data, and begin to provide digital current differential protection of the transmission line.

Because of the communications latency, the synchro-phasor also provides an alignment service. That is, it matches local phasors with remote phasors that arise from the same time window. This is a non-trivial task, because of the possibility of lost data or data that arrives out of sequence under normal operation.

During normal operation, the synchro-phasor exchange service attempts to exchange phasors redundantly. That is, two copies of the data are transmitted over physically independent paths. That way, if one path fails, data is likely available over the other.

Occasionally the communications network may switch the physical path between the two terminals, thereby changing the latency. In the case of a switch to a shorter path, it is possible to receive data out of order. In that case, it is permissible to throw some data away, on the theory that more will be arriving shortly.

On rare occasions, the GPS clock at one or both of the terminals may become unavailable. In that case, it is desired to automatically throw over to the use of the communications network to maintain the synchronization of the sampling clock(s), although the protection function will need to be informed of the loss of the GPS clock, and will need an estimate of the synchronization error. In the case of loss of clock synchronization altogether, the protection function also needs to be notified.

On resumption of clock synchronization following a loss of synchronization, there are two options: a step reset of the sampling clock, or a gradual ramping. As far as the protection function is concerned, either approach is acceptable, but protection is turned off until complete resynchronization is attained.

1.5 Actor (Stakeholder) Roles

Actor groupings include applications that use synchro-phasor measurements, and services that this function is built on. Applications receive time-tagged, synchronized phasor measurements, both phase quantities and sequence quantities, as well as estimates of the actual frequency.

<i>Grouping (Community)</i>		<i>Group Description</i>
Synchro-phasor Client		Any monitoring, control, or protection function that requires remote measurements.
<i>Actor Name</i>	<i>Actor Type (person, device, system etc.)</i>	<i>Actor Description</i>
General phasor client	function	Any monitoring, control, or protection function that could request phasor measurements.
Synchro-phasor subscriber	function	Any client that subscribes to a continuous stream of synchronized, time-tagged phasor measurements.
Synchro-phasor requestor	function	Any client that requests a single snapshot of synchronized, time-tagged phasor measurements.

<i>Grouping(Community)</i>		<i>Group Description</i>
Synchro-phasor Supporting Service		Services that support the synchro-phasor system
<i>Actor Role Name</i>	<i>Actor Type (person, device, system etc.)</i>	<i>Role Description</i>
host device	device	The gathering of data generally requires a host device to provide the basic hardware functions for supporting the measurements, such as sensors, filters, A/D converters, etc.
TimeSynchronizationDevice	function	A globally synchronized local clock that is used to control the timing of data sampling and the time-tagging of phasors. Usually provided by the host device.
SamplingDevice	device	A device such as a variable frequency oscillator (VCO), delta-sigma A/D converter, or simple A/D converter, for converting analog information into digital form. Usually provided by the host device.
Communications interface	device	The interface to the wide area communications network. Usually provided by the host device.
Clock monitor	function	A function that monitors the sampling clock to ensure synchronization.
PhasorMeasurementUnit	device	Phasor measurement unit

Replicate this table for each logic group.

1.6 Information exchanged

Describe any information exchanged in this template.

<i>Information Object Name</i>	<i>Information Object Description</i>

1.7 Activities/Services

Describe or list the activities and services involved in this Function (in the context of this Function). An activity or service can be provided by a computer system, a set of applications, or manual procedures. These activities/services should be described at an appropriate level, with the understanding that sub-activities and services should be described if they are important for operational issues, automation needs, and implementation reasons. Other sub-activities/services could be left for later analysis.

<i>Activity/Service Name</i>	<i>Activities/Services Provided</i>
Phasor computation	Compute and provide the synchronized, time-tagged, fundamental power frequency components of voltages and currents for each phase. The theoretical basis for the calculation is providing a least mean square error fit of a sine wave to the samples over a given time window, using a fixed sampling frequency. Corrections should be made for errors caused by off-nominal frequency.
Total vector error estimation	Many clients of this function will find it useful to have some estimate of how well (or poorly) the data samples fit a sine wave. This can be provided by a total vector error estimate.
Sequence components computation	Compute and provide positive, negative, and zero sequence components of voltages and currents.
Frequency estimation	Estimate and provide the actual frequency of the power system at that node from the data samples. Of course, each node may be at a different frequency.
Subscription alignment and validation	A client will usually subscribe to data streams from several nodes, which will not necessarily arrive at the same time, because of variations in communications latencies. Nearly all client calculations require a set of phasors collected at the same time. For this reason, it is necessary to provide an alignment function, that packages the separate, unaligned node subscriptions into a

<i>Activity/Service Name</i>	<i>Activities/Services Provided</i>
	coherent picture, keeping in mind that individual phasors may be lost, corrupted, or arrive out of order.
Measurement identification	Clients of synchro phasors will need a way to find out what measurements are available from a measurement node, and to be able to identify the measurements with physical locations in the power grid.
Self description	Clients of synchro phasors will need a way to find out the values of various parameters used in the computation of particular phasors, since it may turn out that they are not the same throughout the system. Parameters are described in the next section.

1.8 Contracts/Regulations

There are several key performance parameters that are relevant to the application of synchro-phasors, that can be derived from an analysis of the requirements of the applications that use synchro-phasors. Standards are beginning to emerge, such as the proposed IEEE standard, C37.118, "IEEE Standard for Synchrophasors for Power Systems". However, several issues are still being debated and remain to be resolved. It is hoped that analysis of synchro-phasors with respect to control applications will shed some light and resolve some issues.

There are three technical areas to be considered: phasor measurement, synchronization, and communications. Phasor measurement is concerned with estimating the fundamental power system frequency component. Synchronization is concerned with taking measurements in a wide area at the same time. Communications is concerned with transporting the measurement from the location where it is made to the location where it is used.

<i>Contract/Regulation</i>	<i>Impact of Contract/Regulation on Function</i>
IEEE 1344-1995	Integrating measurement systems into substation environments, specifying data output formats, and assuring that the measurement processes are producing comparable results
Draft C37.118	The SYNCHROPHASOR standard defines the synchronizing input and the data output for phasor measurements made by substation computer systems. It also discusses the processes involved in computing phasors from sampled data. It is hoped that this standard will be of considerable value to the developers and users of digital computer based substation systems.

<i>Policy</i>	<i>From Actor</i>	<i>May</i>	<i>Shall Not</i>	<i>Shall</i>	<i>Description (verb)</i>	<i>To Actor</i>

<i>Constraint</i>	<i>Type</i>	<i>Description</i>	<i>Applies to</i>

2 Step by Step Analysis of Function

Describe steps that implement the function. If there is more than one set of steps that are relevant, make a copy of the following section grouping (Preconditions and Assumptions, Steps normal sequence, and Steps alternate or exceptional sequence, Post conditions)

2.1 Steps to implement function

Name of this sequence.

2.1.1 Preconditions and Assumptions

Describe conditions that must exist prior to the initiation of the Function, such as prior state of the actors and activities

Identify any assumptions, such as what systems already exist, what contractual relations exist, and what configurations of systems are probably in place

Identify any initial states of information exchanged in the steps in the next section. For example, if a purchase order is exchanged in an activity, its precondition to the activity might be 'filled in but unapproved'.

<i>Actor/System/Information/Contract</i>	<i>Preconditions or Assumptions</i>
TimeSynchronizationDevice	Prior to publication of synchro-phasors, the underlying sampling clock shall be synchronized to the other clocks in the system.
communication interface	Prior to publication of synchro-phasors, the communication interface must be initialized.
Phasor publication enabled	Phasor publication is enabled after the sampling clock is synchronized and the communication interface is ready.

2.1.2 Steps – Normal Sequence

Describe the normal sequence of events, focusing on steps that identify new types of information or new information exchanges or new interface issues to address. Should the sequence require detailed steps that are also used by other functions, consider creating a new “sub” function, then referring to that “subroutine” in this function. Remember that the focus should be less on the algorithms of the applications and more on the interactions and information flows between “entities”, e.g. people, systems, applications, data bases, etc. There should be a direct link between the narrative and these steps.

The numbering of the sequence steps conveys the order and concurrency and iteration of the steps occur. Using a Dewey Decimal scheme, each level of nested procedure call is separated by a dot ‘.’. Within a level, the sequence number comprises an optional letter and an integer number. The letter specifies a concurrent sequence within the next higher level; all letter sequences are concurrent with other letter sequences. The number specifies the sequencing of messages in a given letter sequence. The absence of a letter is treated as a default ‘main sequence’ in parallel with the lettered sequences.

Sequence 1:

*1.1 - Do step 1
1.2A.1 - In parallel to activity 2 B do step 1
1.2A.2 - In parallel to activity 2 B do step 2
1.2B.1 - In parallel to activity 2 A do step 1
1.2B.2 - In parallel to activity 2 A do step 2
1.3 - Do step 3
1.3.1 - nested step 3.1
1.3.2 - nested step 3.2*

Sequence 2:

*2.1 - Do step 1
2.2 - Do step 2*

#	Event	Primary Actor	Name of Process/Activity	Description of Process/Activity	Information Producer	Information Receiver	Name of Info Exchanged	Additional Notes	IECSA Environments
#	<i>Triggering event? Identify the name of the event.¹</i>	<i>What other actors are primarily responsible for the Process/Activity? Actors are defined in section0.</i>	<i>Label that would appear in a process diagram. Use action verbs when naming activity.</i>	<i>Describe the actions that take place in active and present tense. The step should be a descriptive noun/verb phrase that portrays an outline summary of the step. "If ...Then...Else" scenarios can be captured as multiple Actions or as separate steps.</i>	<i>What other actors are primarily responsible for Producing the information? Actors are defined in section0.</i>	<i>What other actors are primarily responsible for Receiving the information? Actors are defined in section0. (Note – May leave blank if same as Primary Actor)</i>	<i>Name of the information object. Information objects are defined in section 1.6</i>	<i>Elaborate architectural issues using attached spreadsheet. Use this column to elaborate details that aren't captured in the spreadsheet.</i>	<i>Reference the applicable IECSA Environment containing this data exchange. Only one environment per step.</i>
1.1	Phasor computation	PhasorMeasurementUnit	Compute phasor	Local phasor measurements are handed off for publication.					NA
1.2A.1	Request for subscription	General phasor client	Request phasor subscription	Request that local phasor measurements be transmitted to a remote client	General phasor client	Communications interface			Intra-Control Center
1.2A.2	Cancellation of subscription	Synchro-phasor subscriber	Cancel phasor subscription	Cancellation of a previous subscription request	Synchro-phasor subscriber	Communications interface			Intra-Control Center
1.2B	Request for phasor	Synchro-phasor requestor	Request local phasor measurement	Request that a single local phasor measurement be transmitted to a local client	Synchro-phasor requestor	Communications interface			Intra-Control Center

2.1.3 Steps – Alternative / Exception Sequences

Describe any alternative or exception sequences that may be required that deviate from the normal course of activities. Note instructions are found in previous table.

¹ Note – A triggering event is not necessary if the completion of the prior step – leads to the transition of the following step.

#	Event	Primary Actor	Name of Process/Activity	Description of Process/Activity	Information Producer	Information Receiver	Name of Info Exchanged	Additional Notes	IECSA Environments
2.1	Loss of clock synchronization		Censor phasor data	Loss of synchronization triggers either censoring of phasor data, or indication that the phasors are not synchronized, or an estimate of the synch error.	Clock monitor	Communications interface			NA
2.2	Clock recovery		Resume normal operation	Normal operation is resumed.	Clock monitor	Communications interface			NA

2.1.4 Post-conditions and Significant Results

Describe conditions that must exist at the conclusion of the Function. Identify significant items similar to that in the preconditions section.

Describe any significant results from the Function

<i>Actor/Activity</i>	<i>Post-conditions Description and Results</i>

2.2 Architectural Issues in Interactions

Elaborate on all architectural issues in each of the steps outlined in each of the sequences above. Reference the Step by number.



Microsoft Excel
Worksheet

2.3 Diagram

For clarification, draw (by hand, by Power Point, by UML diagram) the interactions, identifying the Steps where possible.

3 Auxiliary Issues

3.1 References and contacts

Documents and individuals or organizations used as background to the function described; other functions referenced by this function, or acting as “sub” functions; or other documentation that clarifies the requirements or activities described. All prior work (intellectual property of the company or individual) or proprietary (non-publicly available) work must be so noted.

ID	Title or contact	Reference or contact information
[1]		
[2]		

3.2 Action Item List

As the function is developed, identify issues that still need clarification, resolution, or other notice taken of them. This can act as an Action Item list.

ID	Description	Status
[1]		
[2]		

3.3 Revision History

For reference and tracking purposes, indicate who worked on describing this function, and what aspect they undertook.

No	Date	Author	Description
0.			

Voltage Security

1 Descriptions of Function

Based on the work done by Dick Schulz at AEP and the paper by Nuqui, Phadke, Schulz, and Bhatt entitled: Fast On-Line Voltage Security Monitoring Using Synchronized Phasor Measurements and Decision Trees. IEEE 2001.

1.1 Function Name

Voltage Security

1.2 Function ID

IECSA identification number of the function

T-4.1,T-4.18,T-5,T-6.10

1.3 Brief Description

The Voltage Security function is designed to detect severe low voltage conditions based on phasor measurements of Power and Voltage and upon detection, initiate corrective action such as load shed.

1.4 Narrative

It has been shown through simulation that for certain credible contingencies on a power system, there can occur unacceptable consequences that are characterized by severe low voltages, excessively high power and MVar flows, and likely split-up of a utility's interconnections. System studies have shown that a combined measurement of phasor measurements (only angle needed) and power flow can be used to provide a robust (both dependable and secure) indication of proximity of power system collapse. To be included in a typical measurement set are EHV and HV system voltages and generator MVar production. Classification type Decision Trees models are utilized to predict voltage security status. Results of the Decision Tree are executed through control actions on loads and generators throughout the system.

A stressed power system is characterized by widening angular separation of bus voltage angles as it moves towards voltage insecurity. Decision Trees exploit the complex non-linear relationship between voltage security status and generator Vars/angular difference in term of hierarchical rules extracted from a large number of off-line load-flow simulations.

1.5 Actor (Stakeholder) Roles

Describe all the people (their job), systems, databases, organizations, and devices involved in or affected by the Function (e.g. operators, system administrators, technicians, end users, service personnel, executives, SCADA system, real-time database, RTO, RTU, IED, power system). Typically, these actors are logically grouped by organization or functional boundaries or just for collaboration purpose of this use case. We need to identify these groupings and their relevant roles and understand the constituency. The same actor could play different roles in different Functions, but only one role in one Function. If the same actor (e.g. the same person) does play multiple roles in one Function, list these different actor-roles as separate rows.

<i>Grouping (Community)</i>		<i>Group Description</i>
<i>Voltage Security</i>		
<i>Actor Name</i>	<i>Actor Type (person, device, system etc.)</i>	<i>Actor Description</i>
PhasorMeasurementUnit	Device	Source of Phasor measurements of voltage and power
PhasorDataConcentrator	Device	Collection and synchronization of phasor measurements from multiple sites
Decision System	Device	Analyzes the captured data and proposes resultant control solutions. Control options can be displayed on an operator console.
ControlSystem	Device / Operator	Implements the resultant control decision either automatically or manually
GenerationCapacityDatabase	System	Available generation capability throughout the system
CustomerLoad	System	Available sheddable load throughout the system

Replicate this table for each logic group.

1.6 Information exchanged

Describe any information exchanged in this template

<i>Information Object Name</i>	<i>Information Object Description</i>
Phasor Measurement	PMU captured phasor measurement of voltage and power
System state parameter measurement	System state parameters used for power flow analysis
Control decision	The resultant control decision made after analyzing the phasor and power flow, such as load shedding or generation change

1.7 Activities/Services

Describe or list the activities and services involved in this Function (in the context of this Function). An activity or service can be provided by a computer system, a set of applications, or manual procedures. These activities/services should be described at an appropriate level, with the understanding that sub-activities and services should be described if they are important for operational issues, automation needs, and implementation reasons. Other sub-activities/services could be left for later analysis.

<i>Activity/Service Name</i>	<i>Activities/Services Provided</i>
GetPhasorData	The process of subscribing to data from any number of Phasor Measurement Units
CheckData	The process of verifying that there are no errors in the received data packet
TriggerCapture	The process of triggering a data capture and storage of a block of data based on either a local or remote trigger criteria
ValidateControl	The process of guaranteeing that a control is legitimate
ValidateData	The process of verifying that the data came from a known source

1.8 Contracts/Regulations

Identify any overall (human-initiated) contracts, regulations, policies, financial considerations, engineering constraints, pollution constraints, and other environmental quality issues that affect the design and requirements of the Function.

<i>Contract/Regulation</i>	<i>Impact of Contract/Regulation on Function</i>
Sheddable Load Contracts	Defines which customer load can be shed and in what order
Quality Power Contracts	Requires a “high quality” of power to specified customers

<i>Policy</i>	<i>From Actor</i>	<i>May</i>	<i>Shall Not</i>	<i>Shall</i>	<i>Description (verb)</i>	<i>To Actor</i>

<i>Constraint</i>	<i>Type</i>	<i>Description</i>	<i>Applies to</i>

2 Step by Step Analysis of Function

{Primarily equivalent to RM-ODP Computational View and Information View, with Engineering View as part of Assumptions}

2.1 Steps to implement function

Name of this sequence.

2.1.1 Preconditions and Assumptions

Describe conditions that must exist prior to the initiation of the Function, such as prior state of the actors and activities

Identify any assumptions, such as what systems already exist, what contractual relations exist, and what configurations of systems are probably in place

Identify any initial states of information exchanged in the steps in the next section. For example, if a purchase order is exchanged in an activity, its precondition to the activity might be 'filled in but unapproved'.

<i>Actor/System/Information/Contract</i>	<i>Preconditions or Assumptions</i>

2.1.2 Steps – Normal Sequence

Describe the normal sequence of events, focusing on steps that identify new types of information or new information exchanges or new interface issues to address. Should the sequence require detailed steps that are also used by other functions, consider creating a new “sub” function, then referring to that “subroutine” in this function. Remember that the focus should be less on the algorithms of the applications and more on the interactions and information flows between “entities”, e.g. people, systems, applications, data bases, etc. There should be a direct link between the narrative and these steps.

The numbering of the sequence steps conveys the order and concurrency and iteration of the steps occur. Using a Dewey Decimal scheme, each level of nested procedure call is separated by a dot ‘.’. Within a level, the sequence number comprises an optional letter and an integer number. The letter specifies a concurrent sequence within the next higher level; all letter sequences are concurrent with other letter sequences. The number specifies the sequencing of messages in a given letter sequence. The absence of a letter is treated as a default ‘main sequence’ in parallel with the lettered sequences.

Sequence 1:

*1.1 - Do step 1
1.2A.1 - In parallel to activity 2 B do step 1
1.2A.2 - In parallel to activity 2 B do step 2
1.2B.1 - In parallel to activity 2 A do step 1
1.2B.2 - In parallel to activity 2 A do step 2
1.3 - Do step 3
1.3.1 - nested step 3.1
1.3.2 - nested step 3.2*

Sequence 2:

*2.1 - Do step 1
2.2 - Do step 2*

#	Event	Primary Actor	Name of Process/Activity	Description of Process/Activity	Information Producer	Information Receiver	Name of Info Exchanged	Additional Notes	IECSA Environments
#	<i>Triggering event? Identify the name of the event.¹</i>	<i>What other actors are primarily responsible for the Process/Activity? Actors are defined in section0.</i>	<i>Label that would appear in a process diagram. Use action verbs when naming activity.</i>	<i>Describe the actions that take place in active and present tense. The step should be a descriptive noun/verb phrase that portrays an outline summary of the step. "If ...Then...Else" scenarios can be captured as multiple Actions or as separate steps.</i>	<i>What other actors are primarily responsible for Producing the information? Actors are defined in section0.</i>	<i>What other actors are primarily responsible for Receiving the information? Actors are defined in section0. (Note – May leave blank if same as Primary Actor)</i>	<i>Name of the information object. Information objects are defined in section 1.6</i>	<i>Elaborate architectural issues using attached spreadsheet. Use this column to elaborate details that aren't captured in the spreadsheet.</i>	<i>Reference the applicable IECSA Environment containing this data exchange. Only one environment per step.</i>
1	$\Delta\theta > \text{s.p.}$ $\Delta P > \text{s.p.}$ $\Delta V_{\text{var}} > \text{s.p.}$			The PHASORMEASUREMENTUNIT shall continuously send data to the Decisioner. On detection of a trigger event, the PHASORMEASUREMENTUNIT may and the decisioner should log the stream of phasors being delivered	PHASORMEASUREMENTUNIT	Decisioner	Phasor data	Need to be able to synchronize received data	Lower Security DAC
2	Voltage Security Compromised			The decisioner shall issue controls to the controllable devices – either on/off or linear control	Decisioner	Field controllable devices	Controls		Lower Security DAC

¹ Note – A triggering event is not necessary if the completion of the prior step – leads to the transition of the following step.

2.1.3 Steps – Alternative / Exception Sequences

Describe any alternative or exception sequences that may be required that deviate from the normal course of activities. Note instructions are found in previous table.

#	Event	Primary Actor	Name of Process/Activity	Description of Process/Activity	Information Producer	Information Receiver	Name of Info Exchanged	Additional Notes	IECSA Environments

2.1.4 Post-conditions and Significant Results

Describe conditions that must exist at the conclusion of the Function. Identify significant items similar to that in the preconditions section.

Describe any significant results from the Function

<i>Actor/Activity</i>	<i>Post-conditions Description and Results</i>

2.2 Architectural Issues in Interactions

Elaborate on all architectural issues in each of the steps outlined in each of the sequences above. Reference the Step by number.



Microsoft Excel
Worksheet

2.3 Diagram

For clarification, draw (by hand, by Power Point, by UML diagram) the interactions, identifying the Steps where possible.

3 Auxiliary Issues

3.1 References and contacts

Documents and individuals or organizations used as background to the function described; other functions referenced by this function, or acting as “sub” functions; or other documentation that clarifies the requirements or activities described. All prior work (intellectual property of the company or individual) or proprietary (non-publicly available) work must be so noted.

ID	Title or contact	Reference or contact information
[1]		
[2]		

3.2 Action Item List

As the function is developed, identify issues that still need clarification, resolution, or other notice taken of them. This can act as an Action Item list.

ID	Description	Status
[1]		
[2]		

3.3 Revision History

For reference and tracking purposes, indicate who worked on describing this function, and what aspect they undertook.

No	Date	Author	Description
v00			
rev01	1/12/04	Ellen Liu	New Format

This page intentionally left blank.

Market Operations – Post Dispatch

1 Descriptions of Functions – Post Dispatch Market Operations

All prior work (intellectual property of the company or individual) or proprietary (non-publicly available) work should be so noted.

1.1 Function Name

Name of Function

Post Dispatch Market Operations across 3 Western Regional Transmission Organizations (RTOs)

1.2 Function ID

IECSA identification number of the function

M-6

1.3 Brief Description

Describe briefly the scope, objectives, and rationale of the Function.

As the electricity industry is deregulated, and as FERC defines more clearly what the market operation tariffs will encompass, three possible Regional Transmission Organizations (RTOs) in the Western Interconnection are developing seamless interfaces for Market Participants to submit energy schedules and ancillary service bids across these 3 RTOs. The 3 RTOs are California ISO (existing ISO handling the electricity market in California), RTO West (potential RTO of many northwestern utilities), and WestConnect (potential RTO of many southwestern utilities). These 3 RTOs are developing the requirements for the Western RTO functions. The descriptions of the functions below may or may not represent the final market rules and market operations, because these have not been finalized yet.

1.4 Narrative

A complete narrative of the Function from a Domain Expert's point of view, describing what occurs when, why, how, and under what conditions. This will be a separate document, but will act as the basis for identifying the Steps in Section 2.

The following is a list of Western RTO functions related to Post Dispatch Market Operations.

Only the listed functions with asterisks are represented in the diagrams and/or step-by-step descriptions in section 2.

1. Post-Dispatch
 - a. Metering Data Collection *
 - Register meters
 - Process meter revenue data
 - b. Transmission and Distribution Schedule Checkout *
 - c. Financial Settlements *
 - LMP Calculation
 - Losses calculation
 - Reconcile ISO market
 - Reconcile real-time market
 - Resolve disputes
 - d. Accounting and Billing *
 - Create budget and financial forecast
 - Manage accounts payable
 - Manage accounts receivable
 - Purchasing
 - e. Market Monitoring and Auditing *
 - Develop monitoring criteria
 - Perform market assessment
 - Investigate market abuse

1.5 Actor (Stakeholder) Roles

Describe all the people (their job), systems, databases, organizations, and devices involved in or affected by the Function (e.g. operators, system administrators, technicians, end users, service personnel, executives, SCADA system, real-time database, RTO, RTU, IED, power system). Typically, these actors are logically grouped by organization or functional boundaries or just for collaboration purpose of this use case. We need to identify these groupings and their relevant roles and understand the constituency. The same actor could play different roles in different Functions, but only one role in one Function. If the same actor (e.g. the same person) does play multiple roles in one Function, list these different actor-roles as separate rows.

<i>Grouping (Community)</i>		<i>Group Description</i>
<i>Market Operations</i>		
<i>Actor Name</i>	<i>Actor Type (person, device, system etc.)</i>	<i>Actor Description</i>
Area & Resource Operation Centers	Corporation	Operation Centers which perform AGC and other activities on utility facilities within a specific control area
Auditor	Person	Audits logs and records
Database Administrator	Person	Maintains databases
DisCos	Corporation	Distribution company
Distribution Power System	System	Distribution power system
Eligible Customer Metered Entity	Corporation	A company that has a special relationship with the RTO with respect to market participation
Eligible Customers	Person	Person responsible and authorized to act for the Eligible Customer Metered Entity
GenCos	Corporation	Generation company

<i>Grouping (Community)'</i>		<i>Group Description</i>
<i>Market Operations</i>		
<i>Actor Name</i>	<i>Actor Type (person, device, system etc.)</i>	<i>Actor Description</i>
Interval Meters	Device	Meters that can identify energy usage for different time intervals during the day and week
LGR Owners	Person	Local Generation Resource owner, who manages their Local Generation Resources, which may be larger power plants, distributed energy resources, or load management
Load Profiles	Database	Database of load profiles for different types of customers, based on time of day, day of week, and season
Market Participant	Person	Any participant in the electricity marketplace
Metered Entities	Corporation	Any customer or group of customers that are metered
National Weather Service	Corporation	Provides weather information
NERC	Corporation	National Electric Reliability Council which handles etagging for market operations
Other 2 RTOs	Corporation	For each RTO, this actor represents the other two RTOs in the Western Interconnection
RetailCos	Corporation	Retail companies
RTO Operator	Person	Operator of the power system for the RTO
RTO Programmer /Engineer	Person	Programmer and/or engineer that works for an RTO

<i>Grouping (Community)'</i>		<i>Group Description</i>
<i>Market Operations</i>		
<i>Actor Name</i>	<i>Actor Type (person, device, system etc.)</i>	<i>Actor Description</i>
RTO Scheduler	Person	Person who handles the energy scheduling and ancillary services for an RTO
SC-FTR Owner	Person	Scheduling Coordinator who is also an owner of Firm Transmission Capacity (FTR)
Scheduling Coordinators	Person	Authorized to submit energy schedules and ancillary services bids to the RTO
Settlement Administrator	Person	Person handling the settlement of the financial transactions that took place during market operations
Settlement Data Mgmt Agent	Corporation	Company that provides individual and amalgamated metering data into the settlements process
Standard Customers Meters	Device	Common meters, that are not interval meters
Tag Authority	Corporation	Entity that is responsible for managing e-tagging
Time Line Manager Function	Timer	Timer based on periodicity and/or specific time of day, and/or specific day of week. The timer triggers specific activities
Transmission Owner	Corporation	Owner of transmission circuits
Transmission Power System	Power System	Power system that provides transmission of energy on transmission circuits
WSCC	Corporation/Regulator	Western Systems Coordinating Council

<i>Grouping (Community)'</i>		<i>Group Description</i>
<i>Market Operations</i>		
<i>Actor Name</i>	<i>Actor Type (person, device, system etc.)</i>	<i>Actor Description</i>
Power System Model	Database	Database with model of the power system connectivity and the characteristics of the power system elements
Other RTO Power System Model	Database	Databases with power system models belonging to the other RTOs
Transmission Outage Schedules	Database	Database of schedules of planned outages of transmission equipment for maintenance and/or construction
LGR Generation Maintenance Schedules	Database	Databases of maintenance schedules for local generation resources
Energy Schedules	Database	Database of schedules of energy sources matched with loads
Ancillary Services Schedules	Database	Database of schedules of available ancillary services
Transmission Rights Ownership Database	Database	Database linking owners to transmission rights
FTR Requirements Matrix	Database	Matrix of firm transmission rights requirements to available FTRs
Transmission System Characteristics Database	Database	Database of transmission system characteristics
Existing Transmission Contracts	Database	Database of existing transmission rights contracts
Operating Plan	Database	Database containing the operating plan that will actually be implemented to run the power system

<i>Grouping (Community)'</i>		<i>Group Description</i>
<i>Market Operations</i>		
<i>Actor Name</i>	<i>Actor Type (person, device, system etc.)</i>	<i>Actor Description</i>
Balancing Energy Stack	Database	Database containing the ancillary services that are available for use, organized by price, for balancing the power system generation against load

Replicate this table for each logic group.

1.6 Information Exchanged

Describe any information exchanged in this template.

<i>Information Object Name</i>	<i>Information Object Description</i>

1.7 Activities/Services

Describe or list the activities and services involved in this Function (in the context of this Function). An activity or service can be provided by a computer system, a set of applications, or manual procedures. These activities/services should be described at an appropriate level, with the understanding that sub-activities and services should be described if they are important for operational issues, automation needs, and implementation reasons. Other sub-activities/services could be left for later analysis.

<i>Activity/Service Name</i>	<i>Activities/Services Provided</i>
Maintenance Outage Function	Analyzes maintenance outages

<i>Activity/Service Name</i>	<i>Activities/Services Provided</i>
7-Day Load Forecast Function	Determines the long term load forecast
Congestion Management Function	Determines if congestion could occur
Operations Transmission Capacity	Determines the Operations Transmission Capacity, based on energy schedules
Western Market Interface Web Server	Manages the interface between the RTOs and the Market Participants
Data Acquisition and Control Subsystem	Monitors and controls field devices
Available FTR	Manages FTRs
FTR Market Clearing Price Auction Function	Determines market clearing price of FTRs based on energy schedules
Energy Schedules Analysis Function	Analyzes the energy schedules
Ancillary Services Procurement Analysis	Analyzes the needs for ancillary services
Tag Approval Service	Approves electronic tags

1.8 Contracts/Regulations

Identify any overall (human-initiated) contracts, regulations, policies, financial considerations, engineering constraints, pollution constraints, and other environmental quality issues that affect the design and requirements of the Function.

<i>Contract/Regulation</i>	<i>Impact of Contract/Regulation on Function</i>
Market Tariff	Basis for all actions

<i>Policy</i>	<i>From Actor</i>	<i>May</i>	<i>Shall Not</i>	<i>Shall</i>	<i>Description (verb)</i>	<i>To Actor</i>

<i>Constraint</i>	<i>Type</i>	<i>Description</i>	<i>Applies to</i>

2 Step by Step Analysis of Function

Describe steps that implement the function. If there is more than one set of steps that are relevant, make a copy of the following section grouping (Preconditions and Assumptions, Steps normal sequence, and Steps alternate or exceptional sequence, Post conditions)

2.1 Metering Data Collection (MDC)

2.1.1 MDC – Preconditions and Assumptions

Describe conditions that must exist prior to the initiation of the Function, such as prior state of the actors and activities

Identify any assumptions, such as what systems already exist, what contractual relations exist, and what configurations of systems are probably in place

Identify any initial states of information exchanged in the steps in the next section. For example, if a purchase order is exchanged in an activity, its precondition to the activity might be 'filled in but unapproved'.

<i>Actor/System/Information/Contract</i>	<i>Preconditions or Assumptions</i>
All	Market operations are functioning according to the Market Tariff

2.1.2 MDC – Steps – Normal Sequence

#	Event	Primary Actor	Name of Process/Activity	Description of Process/Activity	Information Producer	Information Receiver	Name of Info Exchanged	Additional Notes	IECSA Environments
									<i>Reference the applicable IECSA Environment containing this data exchange. Only one environment per step.</i>
1a	Every metering cycle	Interval Meters	Provide interval meter readings	Provide interval meter readings	Interval Meters	Eligible Customer Metered Entity	Meter readings		Customer / ESP
1b		Interval Meters	Provide interval meter readings	Provide interval meter readings	Interval Meters	Metered Entities	Meter readings		Customer / ESP
2a		Metered Entities	Provide metering data	Provide metering data	Metered Entities	Settlement Data Mgmt Agent	Meter readings		Customer / ESP
2b		Standard Customers Meters	Provide monthly meter readings	Provide monthly meter readings	Standard Customers Meters	Settlement Data Mgmt Agent	Meter readings		Customer / ESP
2c		Eligible Customer Metered Entity	Provide interval metered data	Provide interval metered data	Eligible Customer Metered Entity	Settlement Data Mgmt Agent	Meter readings		Customer / ESP
2d		Load Profiles	Apply load profiles to non-interval meter readings	Apply load profiles to non-interval meter readings	Load Profiles	Settlement Data Mgmt Agent	Load data		Customer / ESP
3		Metered Entities	Provide metering data	Provide metering data	Metered Entities	Transmission Owner	Meter readings		Control Centers / ESPs

#	Event	Primary Actor	Name of Process/Activity	Description of Process/Activity	Information Producer	Information Receiver	Name of Info Exchanged	Additional Notes	IECSA Environments
4a		Transmission Owner	Provide validated metering data in a standard meter format	Provide validated metering data in a standard meter format	Transmission Owner	RTO Meter Data Management System	Meter readings		RTOs / Market Participants
4b		Settlement Data Mgmt Agent	Provide validated and aggregated metering data in a standard meter format	Provide validated and aggregated metering data in a standard meter format	Settlement Data Mgmt Agent	RTO Meter Data Management System	Meter readings		RTOs / Market Participants

2.1.3 MDC – Steps – Alternative / Exception Sequences

Describe any alternative or exception sequences that may be required that deviate from the normal course of activities. Note instructions are found in previous table.

#	Event	Primary Actor	Name of Process/Activity	Description of Process/Activity	Information Producer	Information Receiver	Name of Info Exchanged	Additional Notes	IECSA Environments

2.1.4 MDC – Post-conditions and Significant Results

Describe conditions that must exist at the conclusion of the Function. Identify significant items similar to that in the preconditions section.

Describe any significant results from the Function

<i>Actor/Activity</i>	<i>Post-conditions Description and Results</i>

2.1.5 MDC – Architectural Issues in Interactions

Elaborate on all architectural issues in each of the steps outlined in each of the sequences above. Reference the Step by number..

2.1.6 MDC – Current Implementation Status

*Describe briefly the current implementation status of the function and/or parts of it, referring to Steps above
Identify the key existing products, standards and technologies*

<i>Product/Standard/Technology</i> Eg. DNP 3	<i>Ref - Usage</i> 2.1.2.1[1] - Exchange of SCADA information

Current Implementations:

<i>Relative maturity of function across industry:</i>	<i>Ref - Status Discussion</i>
Very mature and widely implemented	
Moderately mature	
Fairly new	Fairly new

<i>Relative maturity of function across industry:</i>	<i>Ref - Status Discussion</i>
Future, no systems, no interactions	

<i>Existence of legacy systems involved in function:</i>	<i>Ref - Status Discussion</i>
Many legacy systems	
Some legacy systems	
Few legacy systems	Very few legacy systems
No legacy systems	
Extensive changes will be needed for full functionality	
Moderate changes will be needed	
Few changes will be needed	
No changes will be needed	

<i>Implementation Concerns</i>	<i>Ref - Status Discussion</i>
Data availability and accuracy	
Known and unknown market pressures	Could have market pressures changing functionality
Known and unknown technology opportunities	
Validation of capabilities of function	
Cost vs. benefit	

2.1.7 MDC – Diagram

For clarification, draw (by hand, by Power Point, by UML diagram) the interactions, identifying the Steps where possible.

Metering Data Collection Processes

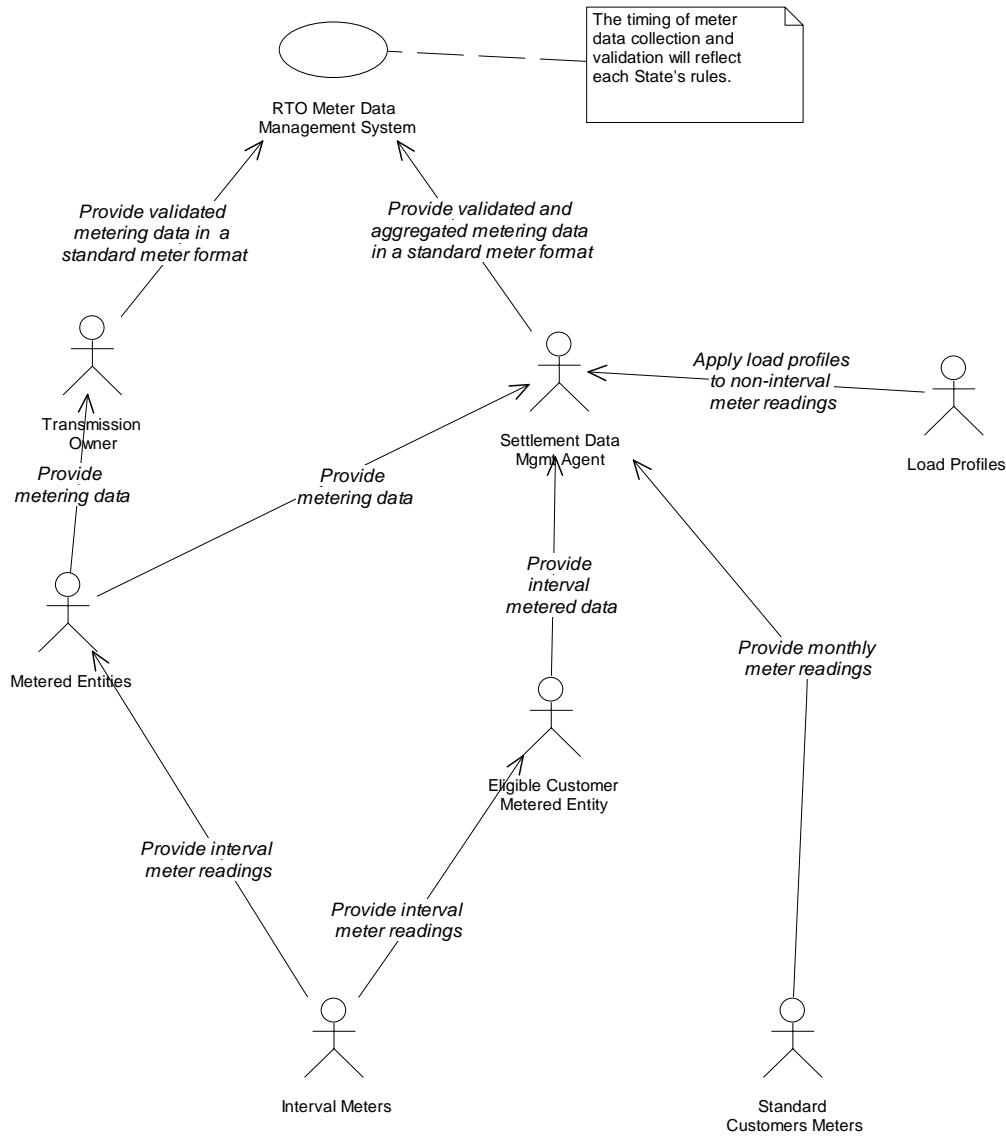

2.2 Transmission and Ancillary Services Schedule Checkout (TASC)

2.2.1 TASC – Preconditions and Assumptions

Describe conditions that must exist prior to the initiation of the Function, such as prior state of the actors and activities

Identify any assumptions, such as what systems already exist, what contractual relations exist, and what configurations of systems are probably in place

Identify any initial states of information exchanged in the steps in the next section. For example, if a purchase order is exchanged in an activity, its precondition to the activity might be 'filled in but unapproved'.

<i>Actor/System/Information/Contract</i>	<i>Preconditions or Assumptions</i>

2.2.2 TASC – Steps – Normal Sequence

#	Event	Primary Actor	Name of Process/Activity	Description of Process/Activity	Information Producer	Information Receiver	Name of Info Exchanged	Additional Notes	IECSA Environments
									<i>Reference the applicable IECSA Environment containing this data exchange. Only one environment per step.</i>
(1a)	Cycle for checking out actual vs. planned energy schedules	Operating Plan	Provide actual schedule	Provide actual schedule	Operating Plan	Settlement System	Actual energy schedule		RTOs / Market Participants
(1b)		Other 2 RTOs	Provide actual schedules from other RTOs	Provide actual schedules from other RTOs	Other 2 RTOs	Settlement System	Actual energy schedule		RTOs / Market Participants
(2)		Settlement Administrator	On 1st day after Trading Day, initiate preliminary schedule checkout	On 1st day after Trading Day, initiate preliminary schedule checkout	Settlement Administrator	Settlement System	Actual energy schedule vs. planned energy schedules		User Interface
(3)		Settlement System	Provide preliminary schedule checkout	Provide preliminary schedule checkout	Settlement System	Scheduling Coordinators	Actual energy schedule vs. planned energy schedules		User Interface

#	Event	Primary Actor	Name of Process/Activity	Description of Process/Activity	Information Producer	Information Receiver	Name of Info Exchanged	Additional Notes	IECSA Environments
(4)		Scheduling Coordinators	By 4th day after Trading Day, file schedule disputes	By 4th day after Trading Day, file schedule disputes	Scheduling Coordinators	Settlement System	Disputed energy schedules		User Interface
(5)		Settlement System	Review and resolve disputes	Review and resolve disputes	Settlement System	Settlement Administrator	Disputes		User Interface
(6)		Settlement Administrator	By 5th day after Trading Day, initiate final schedule checkout	By 5th day after Trading Day, initiate final schedule checkout	Settlement Administrator	Settlement System	Final resolutions on energy schedule		User Interface
(7a)		Settlement System	Report validated schedules to NERC	Report validated schedules to NERC	Settlement System	NERC	Final validated energy schedules		Inter-Corporation
(7b)		Settlement System	Report validated schedules to other RTOs	Report validated schedules to other RTOs	Settlement System	Other RTOs	Final validated energy schedules		RTOs / Market Participants

2.2.3 TASC – Steps – Alternative / Exception Sequences

Describe any alternative or exception sequences that may be required that deviate from the normal course of activities. Note instructions are found in previous table.

#	Event	Primary Actor	Name of Process/Activity	Description of Process/Activity	Information Producer	Information Receiver	Name of Info Exchanged	Additional Notes	IECSA Environments

2.2.4 TASC – Post-conditions and Significant Results

Describe conditions that must exist at the conclusion of the Function. Identify significant items similar to that in the preconditions section.

Describe any significant results from the Function

<i>Actor/Activity</i>	<i>Post-conditions Description and Results</i>

2.2.5 TASC – Architectural Issues in Interactions

Elaborate on all architectural issues in each of the steps outlined in each of the sequences above. Reference the Step by number..

2.2.6 TASC – Current Implementation Status

Describe briefly the current implementation status of the function and/or parts of it, referring to Steps above

Identify the key existing products, standards and technologies

<i>Product/Standard/Technology</i> Eg. DNP 3	<i>Ref - Usage</i> 2.1.2.1[1] - Exchange of SCADA information

Current Implementations:

<i>Relative maturity of function across industry:</i>	<i>Ref - Status Discussion</i>
Very mature and widely implemented	
Moderately mature	
Fairly new	Fairly new
Future, no systems, no interactions	

<i>Existence of legacy systems involved in function:</i>	<i>Ref - Status Discussion</i>
Many legacy systems	
Some legacy systems	
Few legacy systems	Very few legacy systems
No legacy systems	
Extensive changes will be needed for full functionality	
Moderate changes will be needed	
Few changes will be needed	
No changes will be needed	

<i>Implementation Concerns</i>	<i>Ref - Status Discussion</i>
Data availability and accuracy	
Known and unknown market pressures	Could have market pressures changing functionality
Known and unknown technology opportunities	

Validation of capabilities of function
--

Cost vs. benefit

2.2.7 TASC – Diagram

For clarification, draw (by hand, by Power Point, by UML diagram) the interactions, identifying the Steps where possible.

Transmission and Ancillary Services Schedule Checkout Processes

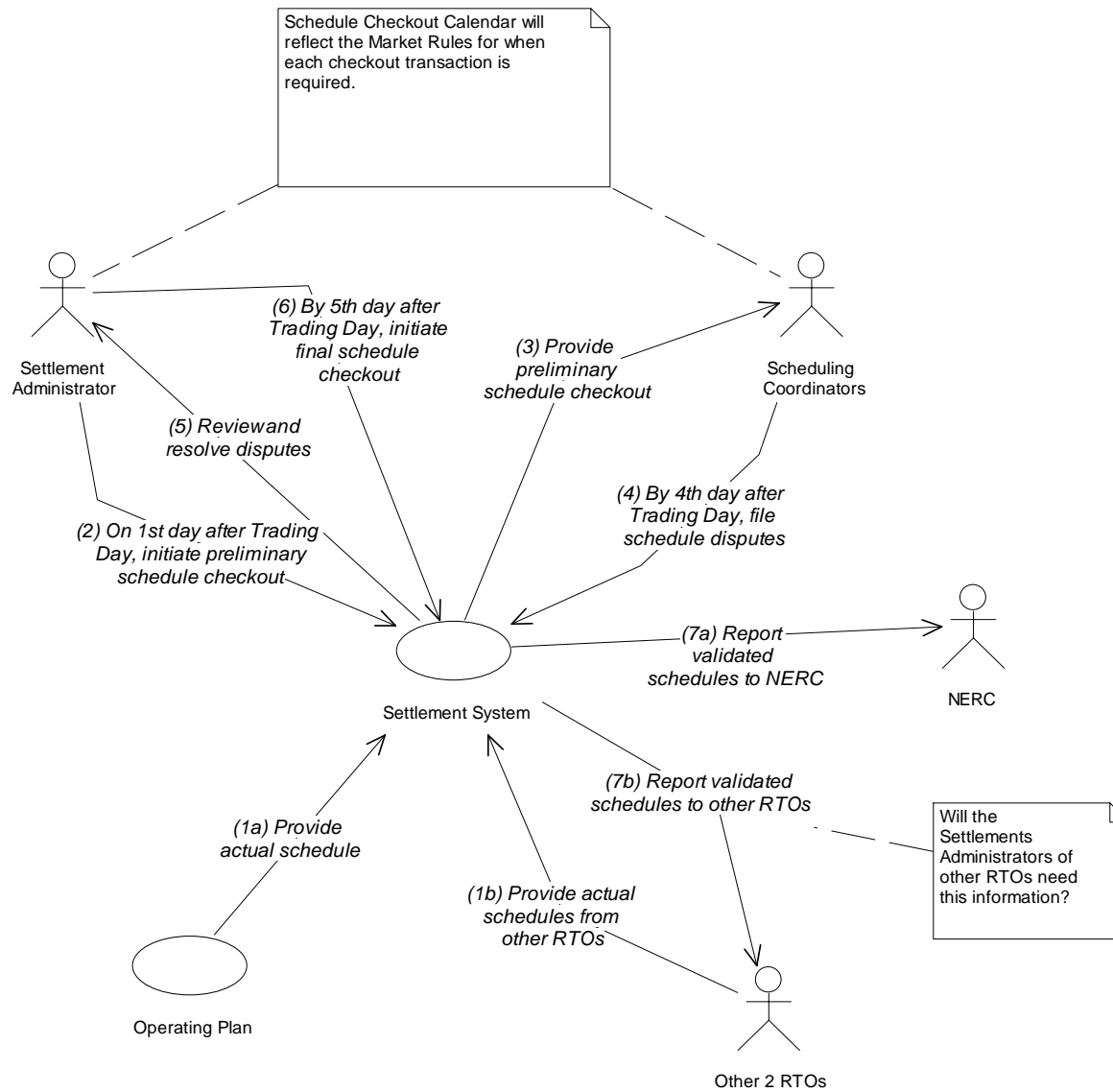

2.3 Market Operations Financial Settlements (MOFS)

2.3.1 MOFS – Preconditions and Assumptions

Describe conditions that must exist prior to the initiation of the Function, such as prior state of the actors and activities

Identify any assumptions, such as what systems already exist, what contractual relations exist, and what configurations of systems are probably in place

Identify any initial states of information exchanged in the steps in the next section. For example, if a purchase order is exchanged in an activity, its precondition to the activity might be 'filled in but unapproved'.

<i>Actor/System/Information/Contract</i>	<i>Preconditions or Assumptions</i>

2.3.2 MOFS – Steps – Normal Sequence

#	Event	Primary Actor	Name of Process/Activity	Description of Process/Activity	Information Producer	Information Receiver	Name of Info Exchanged	Additional Notes	IECSA Environments
									<i>Reference the applicable IECSA Environment containing this data exchange. Only one environment per step.</i>
(1a)	Cycle for handling market operations settlements	RTO Meter Data Management System	Provide metering data	Provide metering data	RTO Meter Data Management System	Settlement System	Metering data		RTOs / Market Participants
(1b)		RTO Meter Data Management System	Provide relevant metering data	Provide relevant metering data	RTO Meter Data Management System	Transmission Owner	Metering data		RTOs / Market Participants
(2)		Settlement Administrator	On day 46 after Trading Day, initiate preliminary settlement	On day 46 after Trading Day, initiate preliminary settlement	Settlement Administrator	Settlement System	Preliminary settlement information		User Interface
(3)		Settlement System	Provide preliminary settlement	Provide preliminary settlement	Settlement System	Scheduling Coordinators	Preliminary settlement information		User Interface
(4)		Scheduling Coordinators	By day 52, file settlement disputes	By day 52, file settlement disputes	Scheduling Coordinators	Settlement System	Any disputed settlements		User Interface

#	Event	Primary Actor	Name of Process/Activity	Description of Process/Activity	Information Producer	Information Receiver	Name of Info Exchanged	Additional Notes	IECSA Environments
(5)		Settlement System	Review and resolve disputes	Review and resolve disputes	Settlement System	Settlement Administrator	Disputed information		User Interface
(6)		Settlement Administrator	By day 58, issue final settlement	By day 58, issue final settlement	Settlement Administrator	Settlement System	Final settlement information		User Interface
(7)		Settlement System	Provide final settlement	Provide final settlement	Settlement System	Scheduling Coordinators	Final settlement information		User Interface

2.3.3 MOFS – Steps – Alternative / Exception Sequences

Describe any alternative or exception sequences that may be required that deviate from the normal course of activities. Note instructions are found in previous table.

#	Event	Primary Actor	Name of Process/Activity	Description of Process/Activity	Information Producer	Information Receiver	Name of Info Exchanged	Additional Notes	IECSA Environments

2.3.4 MOFS – Post-conditions and Significant Results

Describe conditions that must exist at the conclusion of the Function. Identify significant items similar to that in the preconditions section.

Describe any significant results from the Function

<i>Actor/Activity</i>	<i>Post-conditions Description and Results</i>

2.3.5 MOFS – Architectural Issues in Interactions

Elaborate on all architectural issues in each of the steps outlined in each of the sequences above. Reference the Step by number..

2.3.6 MOFS – Current Implementation Status

*Describe briefly the current implementation status of the function and/or parts of it, referring to Steps above
Identify the key existing products, standards and technologies*

<i>Product/Standard/Technology</i> Eg. DNP 3	<i>Ref - Usage</i> 2.1.2.1[1] - Exchange of SCADA information

Current Implementations:

<i>Relative maturity of function across industry:</i>	<i>Ref - Status Discussion</i>
Very mature and widely implemented	
Moderately mature	
Fairly new	Fairly new

<i>Relative maturity of function across industry:</i>	<i>Ref - Status Discussion</i>
Future, no systems, no interactions	

<i>Existence of legacy systems involved in function:</i>	<i>Ref - Status Discussion</i>
Many legacy systems	
Some legacy systems	
Few legacy systems	Very few legacy systems
No legacy systems	
Extensive changes will be needed for full functionality	
Moderate changes will be needed	
Few changes will be needed	
No changes will be needed	

<i>Implementation Concerns</i>	<i>Ref - Status Discussion</i>
Data availability and accuracy	
Known and unknown market pressures	Could have market pressures changing functionality
Known and unknown technology opportunities	
Validation of capabilities of function	
Cost vs. benefit	

2.3.7 MOFS – Diagram

For clarification, draw (by hand, by Power Point, by UML diagram) the interactions, identifying the Steps where possible.

Transmission and Ancillary Services Settlement Process

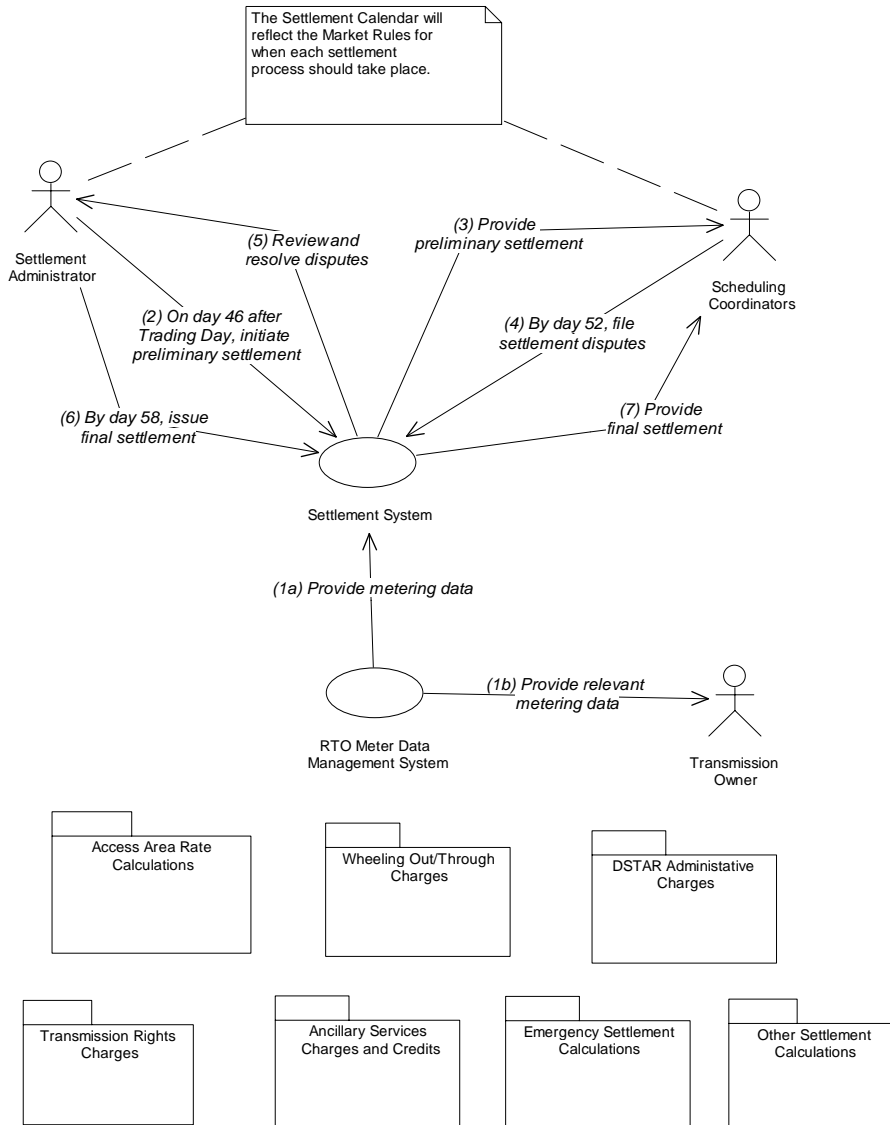

2.4 Market Operations Accounting and Billing (MOAB)

2.4.1 MOAB – Preconditions and Assumptions

Describe conditions that must exist prior to the initiation of the Function, such as prior state of the actors and activities

Identify any assumptions, such as what systems already exist, what contractual relations exist, and what configurations of systems are probably in place

Identify any initial states of information exchanged in the steps in the next section. For example, if a purchase order is exchanged in an activity, its precondition to the activity might be 'filled in but unapproved'.

<i>Actor/System/Information/Contract</i>	<i>Preconditions or Assumptions</i>

2.4.2 MOAB – Steps – Normal Sequence

#	Event	Primary Actor	Name of Process/Activity	Description of Process/Activity	Information Producer	Information Receiver	Name of Info Exchanged	Additional Notes	IECSA Environments
									<i>Reference the applicable IECSA Environment containing this data exchange. Only one environment per step.</i>
(1a)	Cycle for Accounting and Billing	Settlement System	Provide settlement information	Provide settlement information	Settlement System	Billing System	Settlement data		RTOs / Market Participants
(1b)		RTO Meter Data Management System	Provide transmission metering data	Provide transmission metering data	RTO Meter Data Management System	Billing System	Metering data		RTOs / Market Participants
(2)		Settlement Administrator	Issue invoice	By day 91, issue invoice	Settlement Administrator	Billing System	Invoice		User Interface
(3)		Scheduling Coordinators	Pay invoices	By day 96, pay invoices	Scheduling Coordinators	Billing System	Payment		User Interface
(4)		Billing System	Pay Transmission Owners	By day 97, pay Transmission Owners based on metering data	Billing System	Transmission Owner	Payment		User Interface

2.4.3 MOAB – Steps – Alternative / Exception Sequences

Describe any alternative or exception sequences that may be required that deviate from the normal course of activities. Note instructions are found in previous table.

#	Event	Primary Actor	Name of Process/Activity	Description of Process/Activity	Information Producer	Information Receiver	Name of Info Exchanged	Additional Notes	IECSA Environments

2.4.4 MOAB – Post-conditions and Significant Results

Describe conditions that must exist at the conclusion of the Function. Identify significant items similar to that in the preconditions section.

Describe any significant results from the Function

<i>Actor/Activity</i>	<i>Post-conditions Description and Results</i>

2.4.5 MOAB – Architectural Issues in Interactions

Elaborate on all architectural issues in each of the steps outlined in each of the sequences above. Reference the Step by number..

2.4.6 MOAB – Current Implementation Status

Describe briefly the current implementation status of the function and/or parts of it, referring to Steps above
Identify the key existing products, standards and technologies

<i>Product/Standard/Technology</i> Eg. DNP 3	<i>Ref - Usage</i> 2.1.2.1[1] - Exchange of SCADA information

Current Implementations:

<i>Relative maturity of function across industry:</i>	<i>Ref - Status Discussion</i>
Very mature and widely implemented	
Moderately mature	
Fairly new	Fairly new
Future, no systems, no interactions	

<i>Existence of legacy systems involved in function:</i>	<i>Ref - Status Discussion</i>
Many legacy systems	
Some legacy systems	
Few legacy systems	Very few legacy systems
No legacy systems	
Extensive changes will be needed for full functionality	
Moderate changes will be needed	
Few changes will be needed	

No changes will be needed

<i>Implementation Concerns</i>	<i>Ref - Status Discussion</i>
Data availability and accuracy	
Known and unknown market pressures	Could have market pressures changing functionality
Known and unknown technology opportunities	
Validation of capabilities of function	
Cost vs. benefit	

2.4.7 MOAB – Diagram

For clarification, draw (by hand, by Power Point, by UML diagram) the interactions, identifying the Steps where possible.

Accounting and Billing Processes

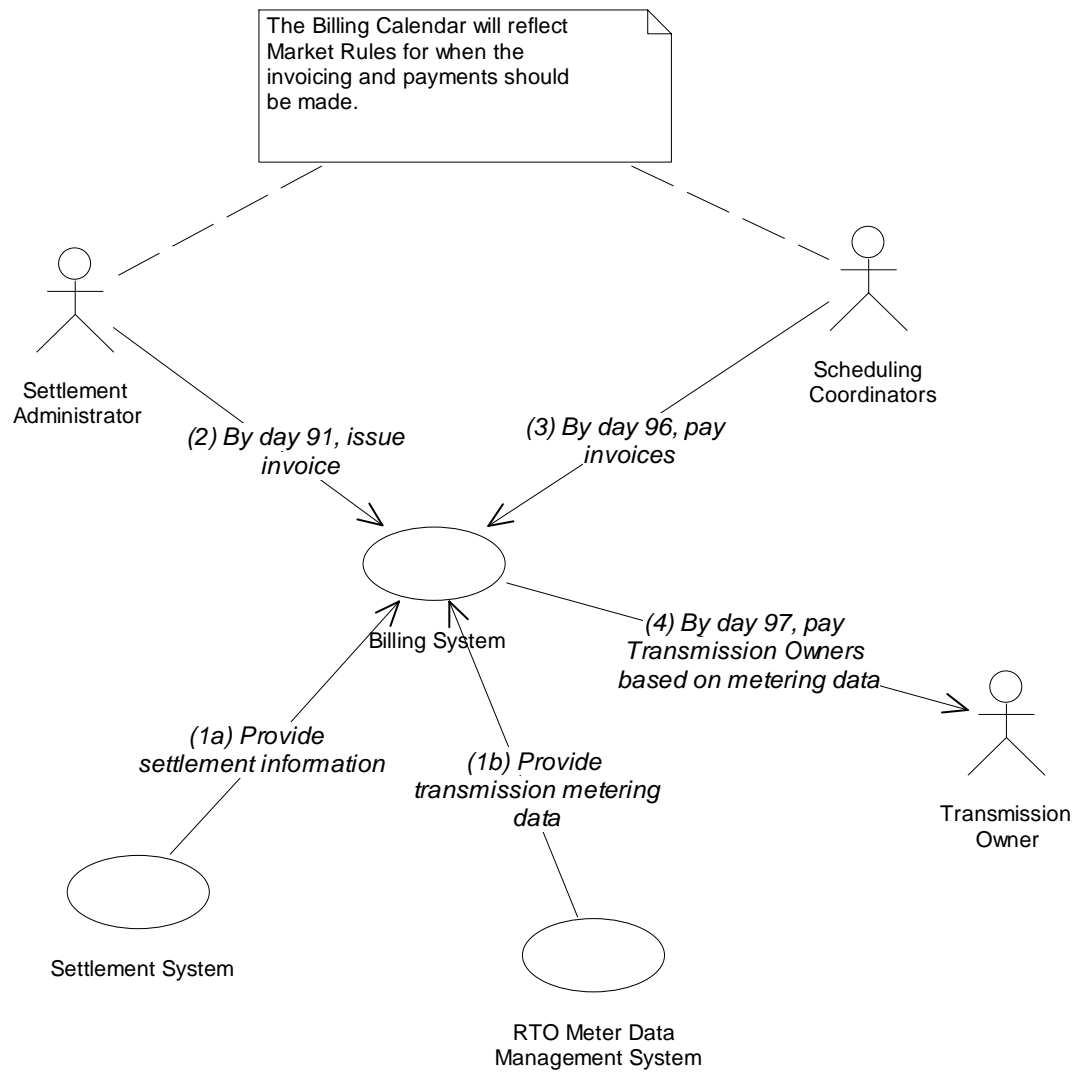

2.5 Market Monitoring and Auditing (MMA)

2.5.1 MMA – Preconditions and Assumptions

Describe conditions that must exist prior to the initiation of the Function, such as prior state of the actors and activities

Identify any assumptions, such as what systems already exist, what contractual relations exist, and what configurations of systems are probably in place

Identify any initial states of information exchanged in the steps in the next section. For example, if a purchase order is exchanged in an activity, its precondition to the activity might be 'filled in but unapproved'.

<i>Actor/System/Information/Contract</i>	<i>Preconditions or Assumptions</i>

2.5.2 MMA – Steps – Normal Sequence

#	Event	Primary Actor	Name of Process/Activity	Description of Process/Activity	Information Producer	Information Receiver	Name of Info Exchanged	Additional Notes	IECSA Environments
									<i>Reference the applicable IECSA Environment containing this data exchange. Only one environment per step.</i>
1a	Periodically or Spot Check	Auditor	Review archival information	Review archival information	Auditor	Archives	Market operations information		Inter-Corporation
1b		Auditor	Review logs	Review logs	Auditor	Logs	Market operations information		Inter-Corporation

2.5.3 MMA – Steps – Alternative / Exception Sequences

Describe any alternative or exception sequences that may be required that deviate from the normal course of activities. Note instructions are found in previous table.

#	Event	Primary Actor	Name of Process/Activity	Description of Process/Activity	Information Producer	Information Receiver	Name of Info Exchanged	Additional Notes	IECSA Environments

2.5.4 MMA – Post-conditions and Significant Results

Describe conditions that must exist at the conclusion of the Function. Identify significant items similar to that in the preconditions section.

Describe any significant results from the Function

<i>Actor/Activity</i>	<i>Post-conditions Description and Results</i>

2.5.5 MMA – Architectural Issues in Interactions

Elaborate on all architectural issues in each of the steps outlined in each of the sequences above. Reference the Step by number..

2.5.6 MMA – Current Implementation Status

Describe briefly the current implementation status of the function and/or parts of it, referring to Steps above
Identify the key existing products, standards and technologies

<i>Product/Standard/Technology</i> Eg. DNP 3	<i>Ref - Usage</i> 2.1.2.1[1] - Exchange of SCADA information

Current Implementations:

<i>Relative maturity of function across industry:</i>	<i>Ref - Status Discussion</i>
Very mature and widely implemented	
Moderately mature	
Fairly new	Fairly new

<i>Relative maturity of function across industry:</i>	<i>Ref - Status Discussion</i>
Future, no systems, no interactions	

<i>Existence of legacy systems involved in function:</i>	<i>Ref - Status Discussion</i>
Many legacy systems	
Some legacy systems	
Few legacy systems	Very few legacy systems
No legacy systems	
Extensive changes will be needed for full functionality	
Moderate changes will be needed	
Few changes will be needed	
No changes will be needed	

<i>Implementation Concerns</i>	<i>Ref - Status Discussion</i>
Data availability and accuracy	
Known and unknown market pressures	Could have market pressures changing functionality
Known and unknown technology opportunities	
Validation of capabilities of function	
Cost vs. benefit	

2.5.7 MMA – Diagram

For clarification, draw (by hand, by Power Point, by UML diagram) the interactions, identifying the Steps where possible.

Market Monitoring and Auditing Processes

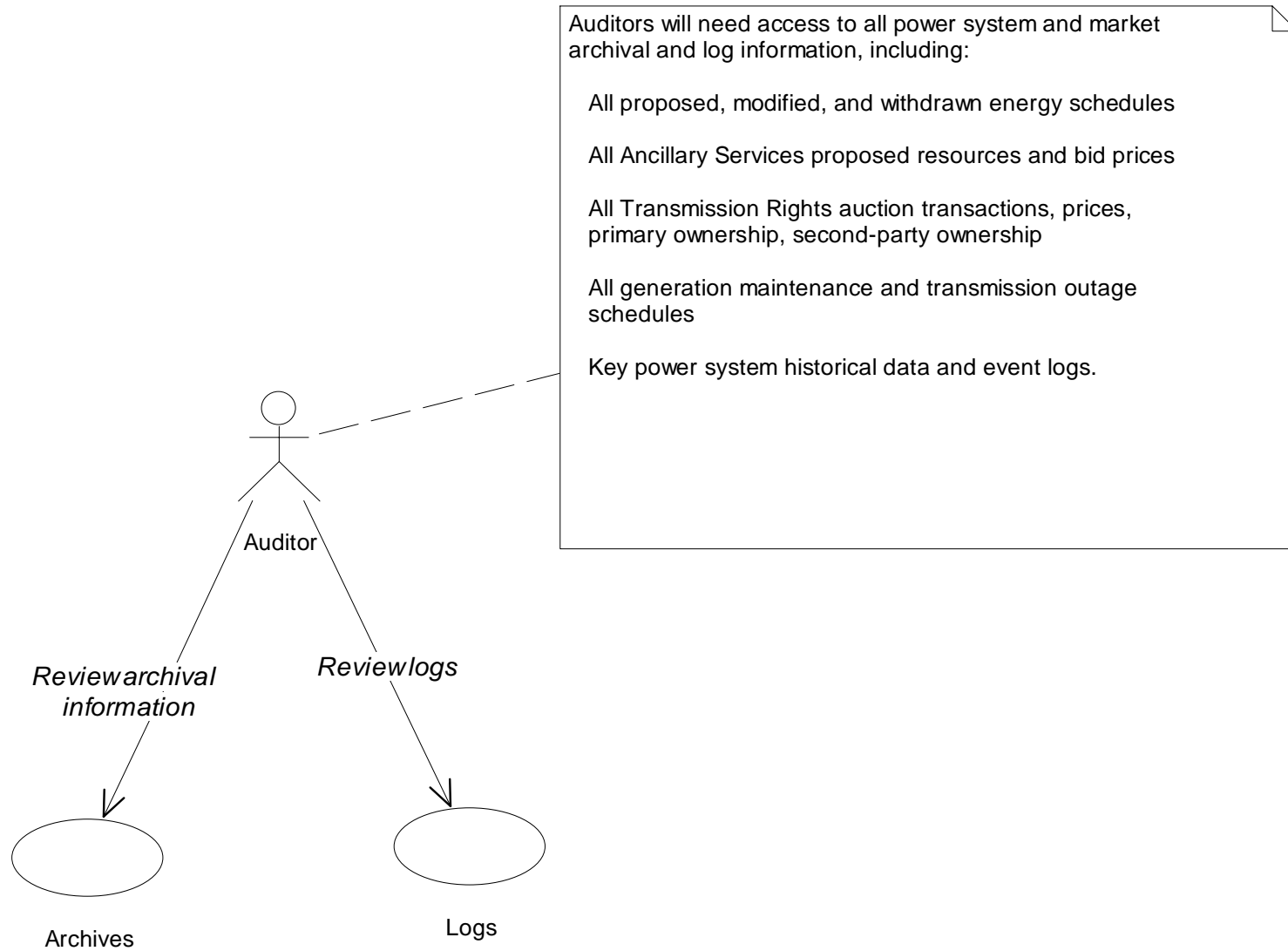

3 Auxiliary Issues

3.1 References and contacts

Documents and individuals or organizations used as background to the function described; other functions referenced by this function, or acting as “sub” functions; or other documentation that clarifies the requirements or activities described. All prior work (intellectual property of the company or individual) or proprietary (non-publicly available) work must be so noted.

ID	Title or contact	Reference or contact information
[1]		
[2]		

3.2 Action Item List

As the function is developed, identify issues that still need clarification, resolution, or other notice taken of them. This can act as an Action Item list.

ID	Description	Status
[1]		
[2]		

3.3 Revision History

For reference and tracking purposes, indicate who worked on describing this function, and what aspect they undertook.

No	Date	Author	Description
0.	Feb 27, 2004	Frances Cleveland	

No	Date	Author	Description