

# Integrated Energy and Communications Systems Architecture (IECSA)



**CEIDS**

**EPRI**



*Electricity  
Innovation  
Institute*

# Poor Power System Reliability: A Toll Felt Throughout the US Economy

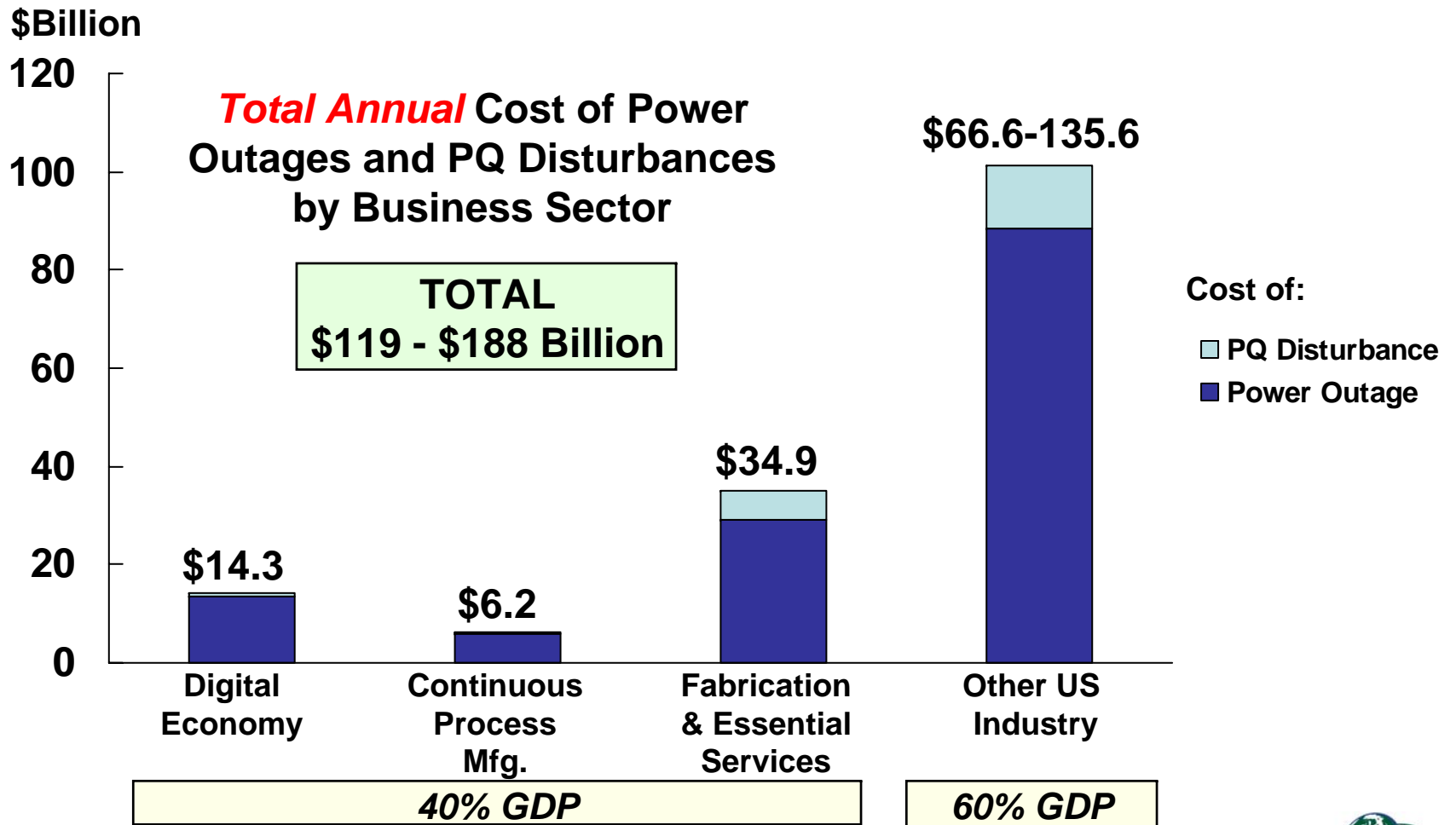

Source: Primen Study: The Cost of Power Disturbances to Industrial & Digital Economy Companies

# The Electric Grid Faces Real Challenges

## Infrastructure Constraints



**Grid Constraints**  
**Operational Constraints**  
**Market Constraints**  
**Aging Infrastructure**

## Vulnerability



TransformerFailure.mpg

**Security**  
**Maintenance**  
**Vandalism**

## Natural Disaster



**..... Acts of God**

# The 2003 Blackout Was a Wakeup Call



*Safety, social, economic, and political impacts*

# Contributing Factors to the Blackout

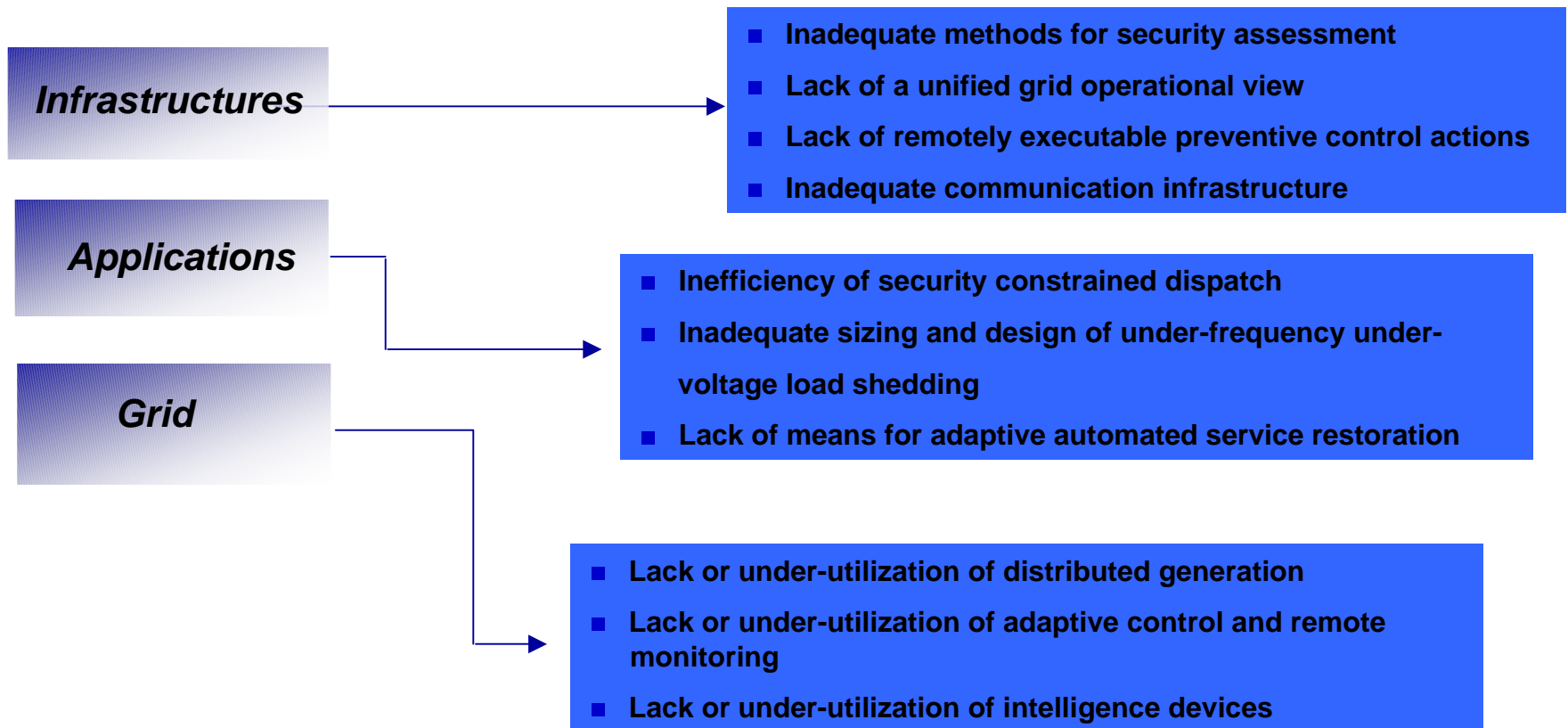

*Challenge to eliminate deficiencies – Overall approach is essential*



# Fundamentals of Grid Reliability

- Proactive failure detection
- Self-healing grid
- Dynamic consumer interface

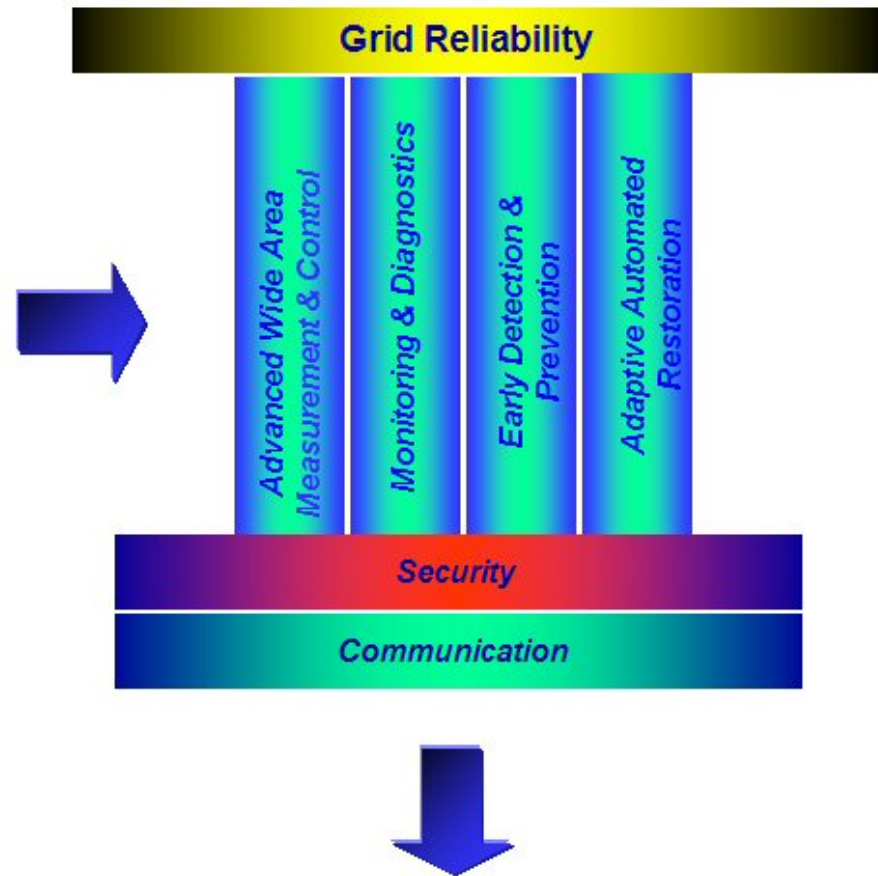

*The key to reliability ..... proactive diagnosis and reactive healing*

# Requirements for Grid Reliability

- Remote monitoring
- Early detection & decision support
- Prevention & recovery
- Fault isolation & restoration
- Crew management
- Emergency backup
- Transfer of authority

*Grid reliability = **grid rehabilitation** – protective + preventive  
+ modern integrated energy and communication infrastructure*

# A New Culture is Needed for Grid Reliability

*Emerging needs for an Integrated Energy and Communication System Architecture (IECSA)*



*A next generation power system consisting of automated transmission and distribution systems supporting efficient and reliable power system operations and handling emergency conditions with automated “self-healing” actions, while at the same time responding to the present and future utility business enterprise, energy market place requirements, and end-customer needs*

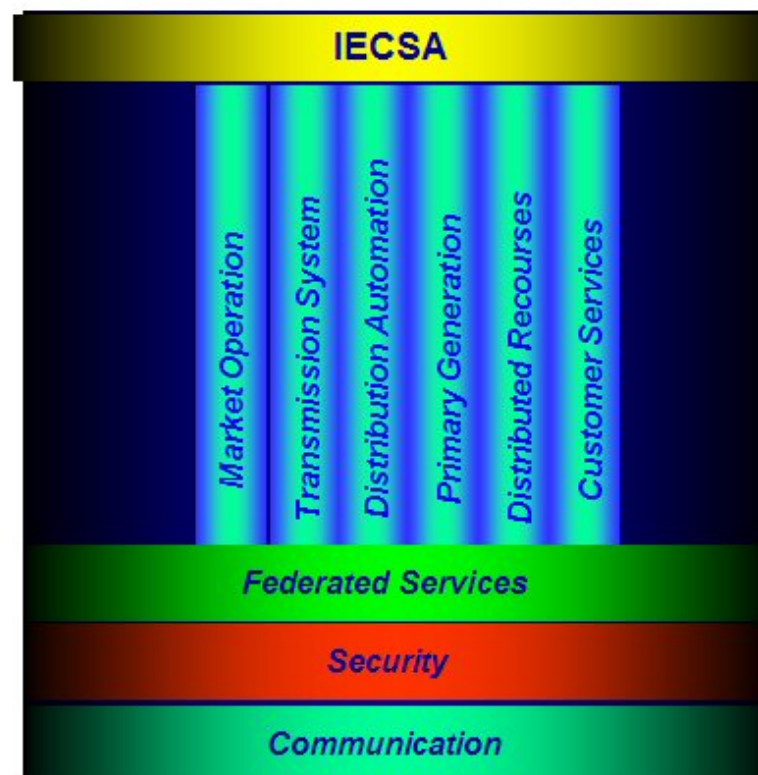

*IECSA: Making the grid smart enough to react to problems before they spread*



## What is IECSA?

A next generation power system consisting of automated transmission and distribution systems that support efficient and reliable power system operations and handle emergency conditions with automated “self-healing” actions, while at the same time responding to present and future utility business enterprise, energy market place requirements, and end-customer needs.

IECSA is an open, standards-based set of blueprints for integrating the data communications networks and intelligent equipment necessary to support the power delivery infrastructure of the future to meet the demands of a digital society.

# The IECSA Concept

## Tomorrow's Utility Network

### The Self-Healing Grid

- Optimization in real-time
- Intelligent islanding
- Simulation and modeling
- Online contingency analysis
- Network-level visualization
- Asset management
- Wide-area monitoring & control

### Integrated Consumer Communications

- Load management
- Real-time pricing
- Equipment monitoring
- Customer-sited generation
- In-building networks
- Power trading and marketing
- Micro-grids

# Integrated Energy and Communications Systems Architecture

## Project Background

- New computing and communications technologies have significant potential for improving utility operations however...
- An open industry-wide distributed computing infrastructure for integrating intelligent equipment is not complete...
- Portions of infrastructure have been under development but significant gaps exist ...

# Integrated Energy and Communications Systems Architecture

## Background: Needs...

- A robust overall technical architecture for data communications and equipment interoperability
- Vendor-neutral, based on open systems and industry standards
- Built upon related ongoing and industry infrastructure and standards work
- Apply latest advancements in systems engineering approaches

# Integrated Energy and Communications Systems Architecture

## Objectives

- Develop a complete set of system requirements for the future power system and connecting consumers to energy markets
- Define an overall system architecture based on analysis of the requirements
- Evaluate proposed architectures and develop recommendations for next phases
- Contribute to relevant standards development organizations as appropriate

# Scope of IECSA

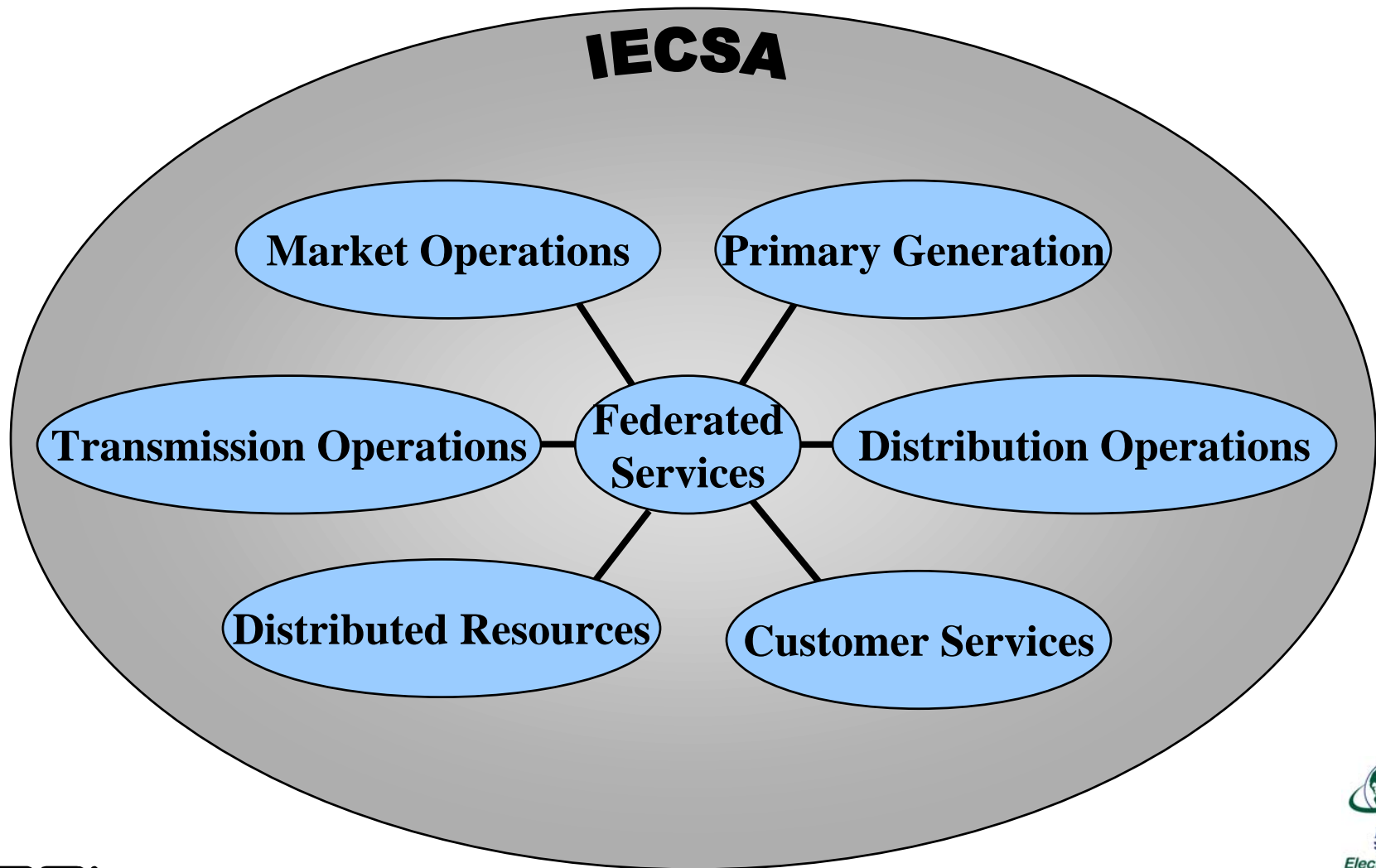

# Dual Infrastructure: Power System Infrastructure

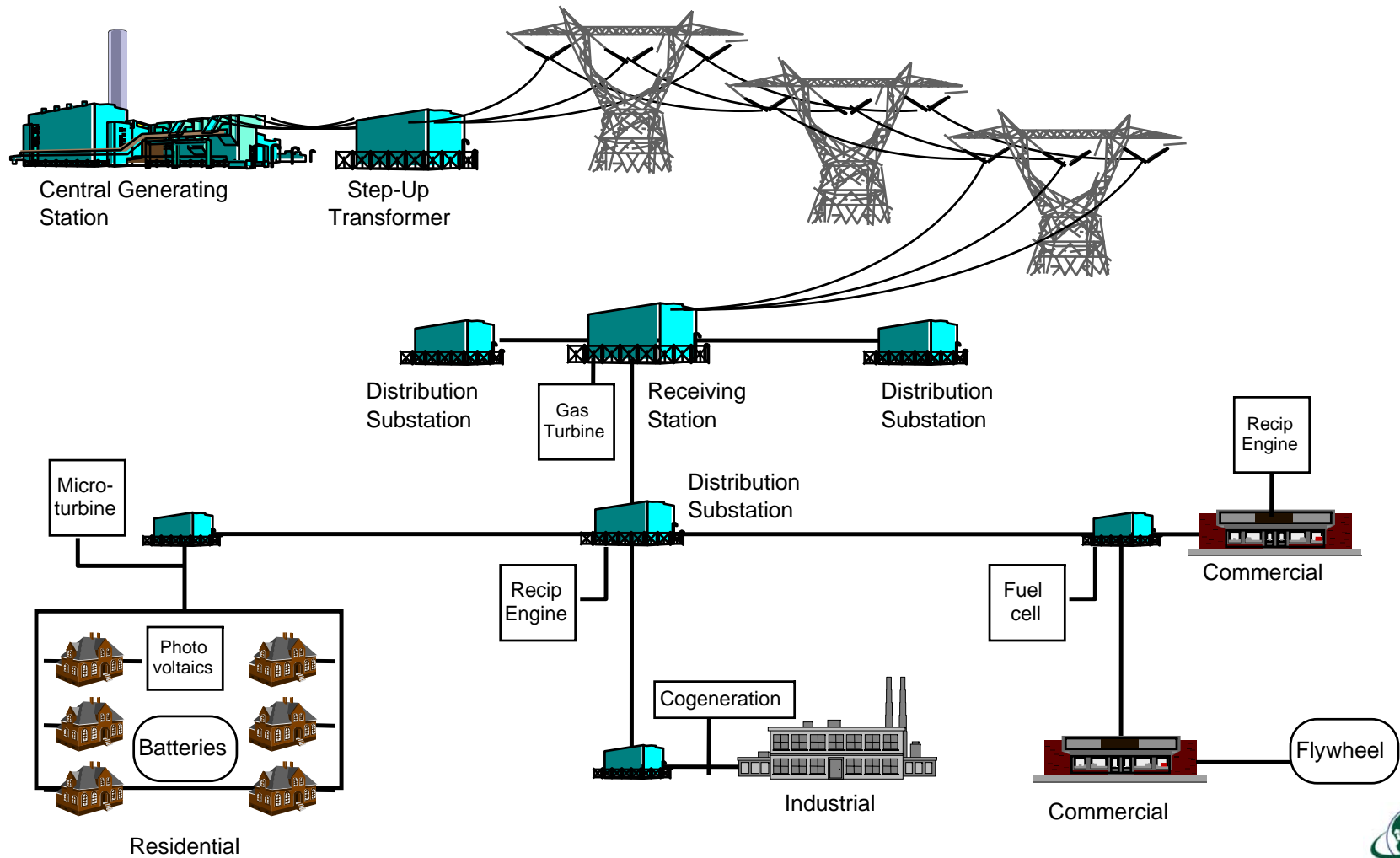

# Dual Infrastructure: Power System Infrastructure and Information Infrastructure

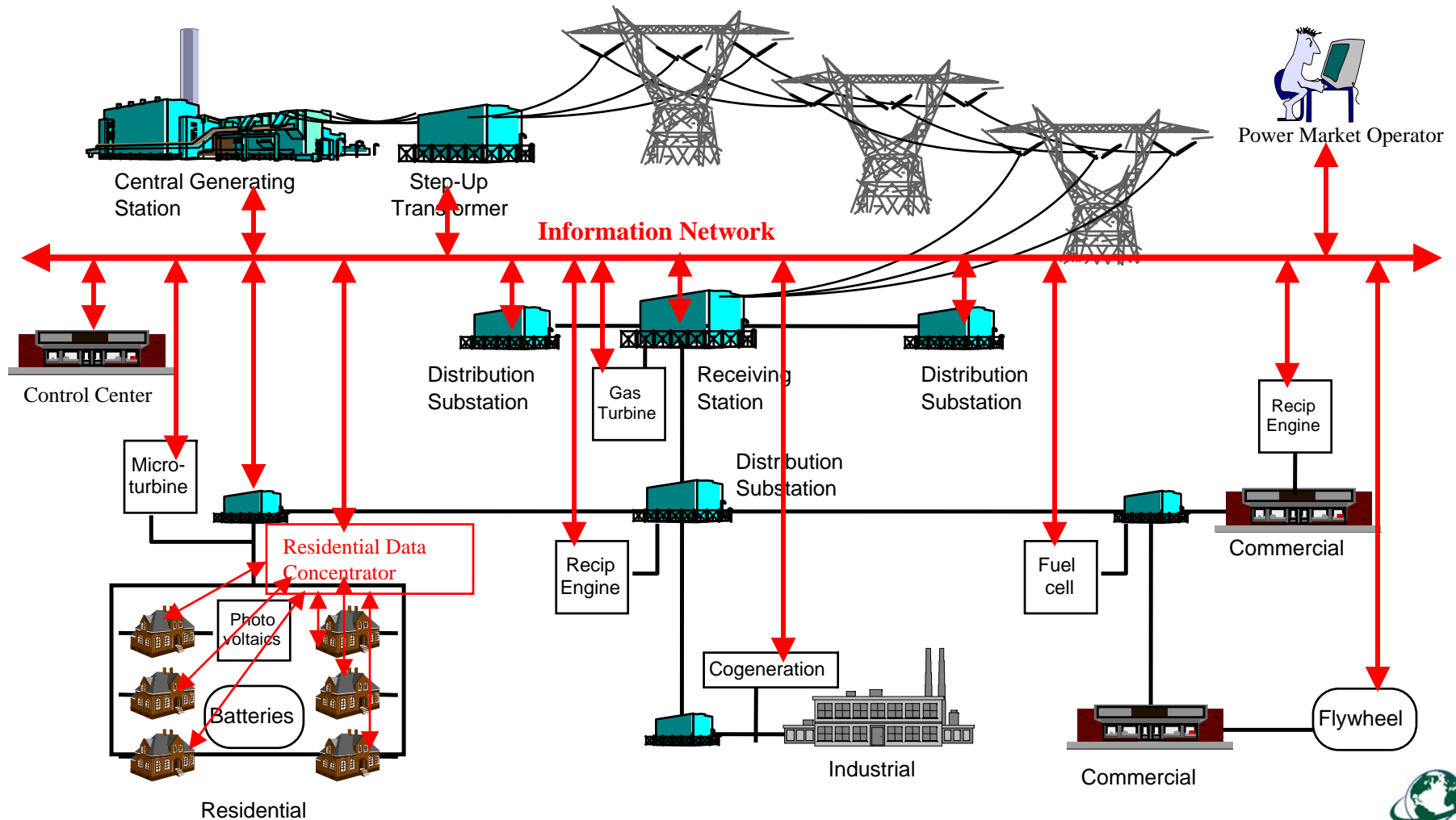



# Why Do We Need an Architecture?

**Lack of interoperability creates a huge integration problem!**

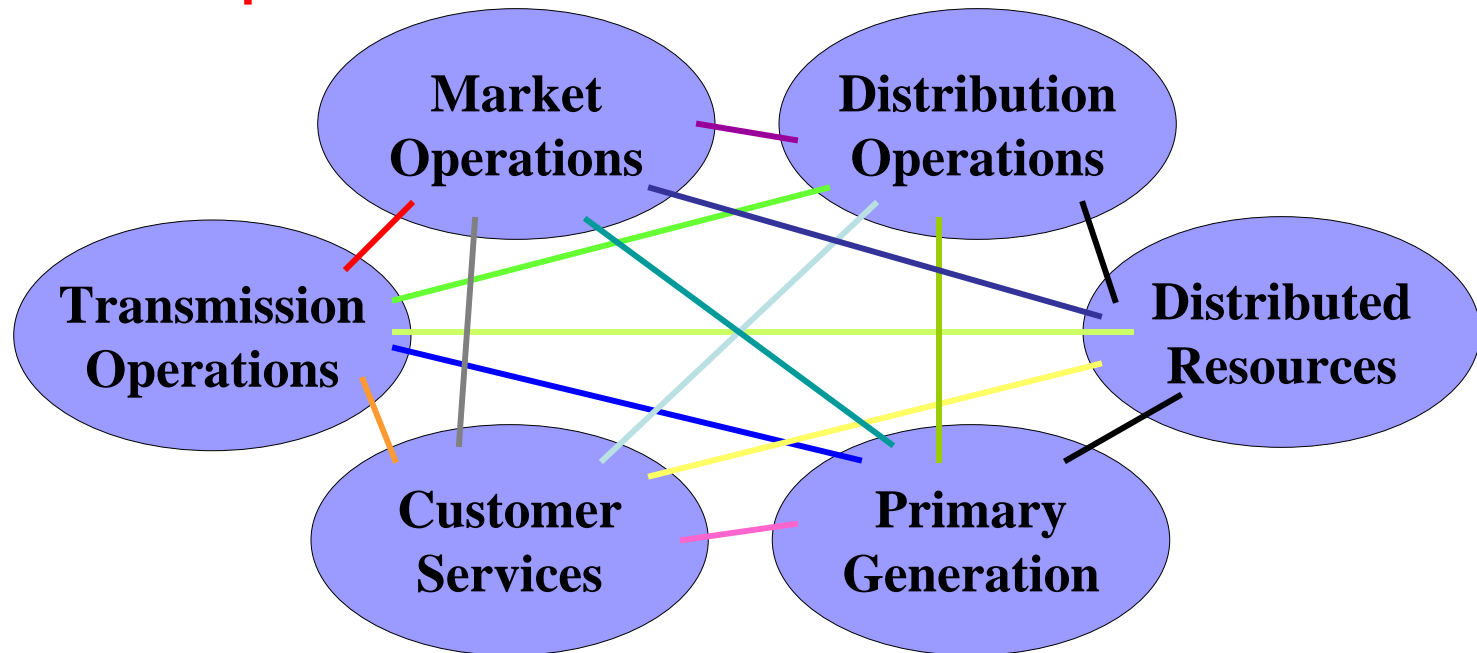

- Everything must know how to talk to everything else
- Culminating explosion of complexity
- System integrators find many solutions for the same thing – no consistency – no leveraging of knowledge

# The Status Quo Functions (Sort Of)

“Middleware” is a good stopgap solution, but...

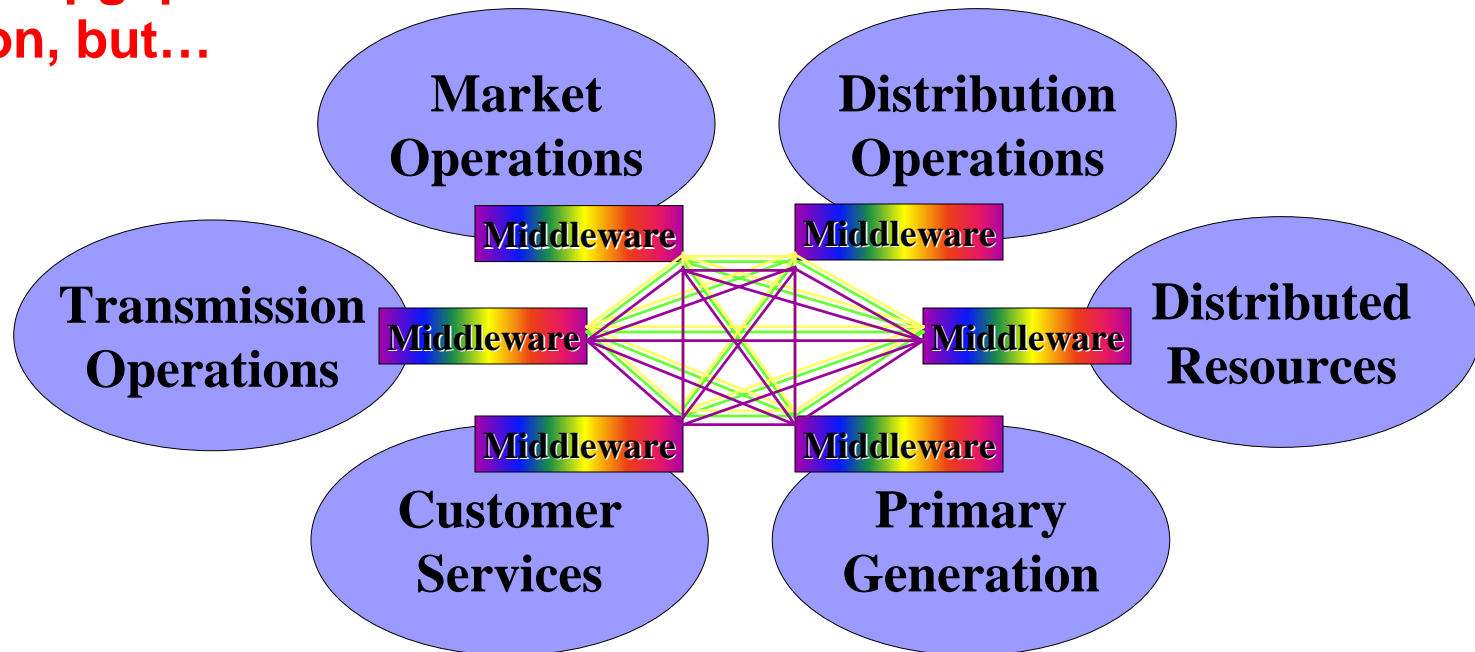

- Interoperable does not always mean interworkable
- Incompatibility between vendors sometimes exists
- Incomplete or ambiguous requirements often lead to poor system integration solutions

# IECSA has an Architecture Development Focus

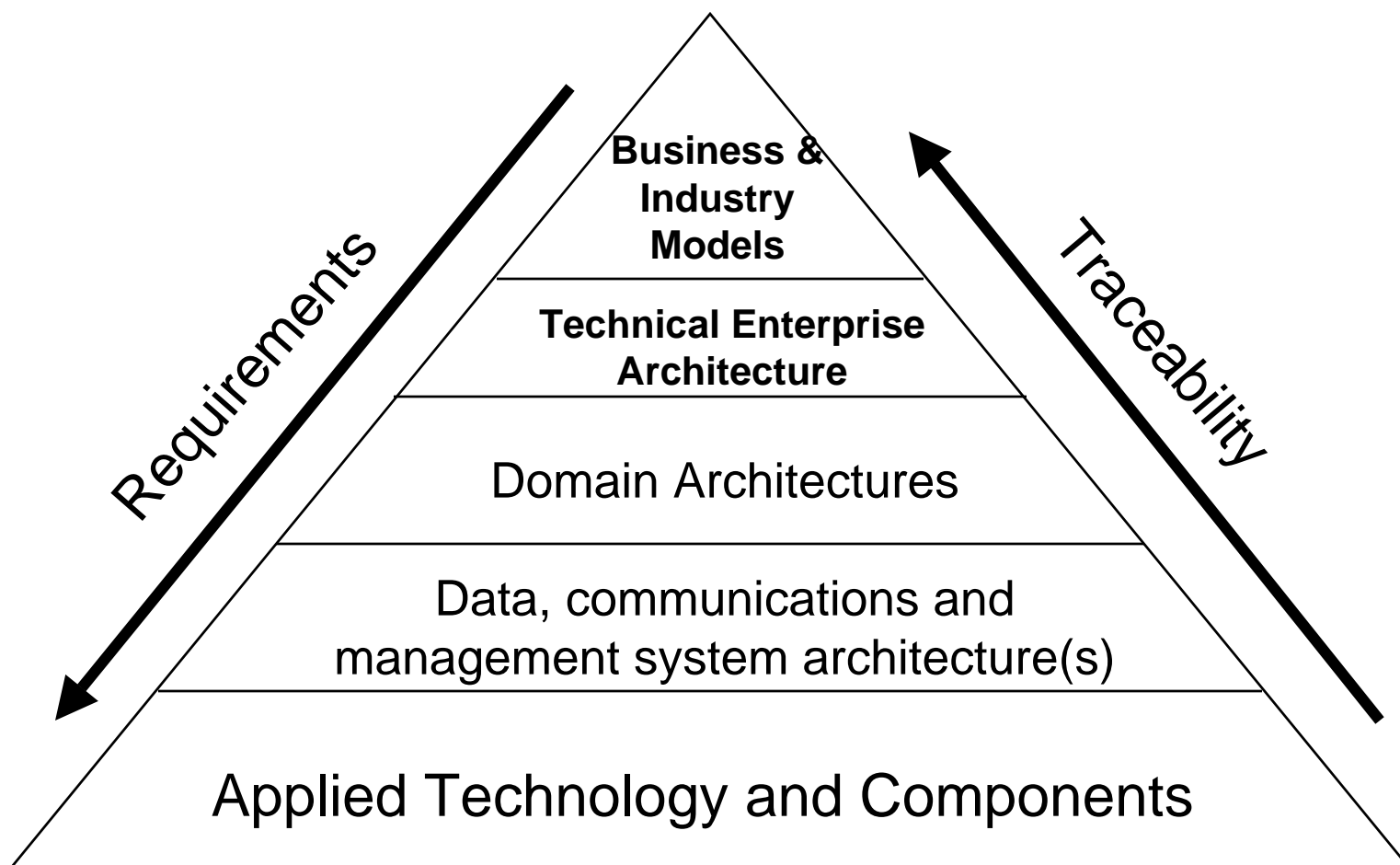

# IECSA Will be an Integrated Architecture

**Self-Healing** and **Adaptive**

**Interactive** with consumers and markets

**Optimized** to make best use of resources and equipment

**Predictive** rather than just reacting to emergencies

**Distributed** across geographical and organizational boundaries

**Integrated**, merging monitoring, control, protection, maintenance, EMS, DMS, marketing, and IT

**Secure** from attack - Some utilities implement these functions now, but not on a wide enough scale to address the needs of the grid as a whole.

Integrated Systems  
Standardized  
Information and Processes



Islands of automation  
Some Interoperability and  
Information Exchange



Isolated non-interoperable  
Systems

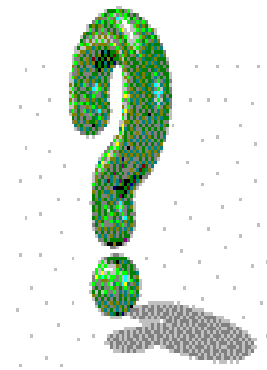

# How is the Architecture Being Developed?



## Example of a Building:

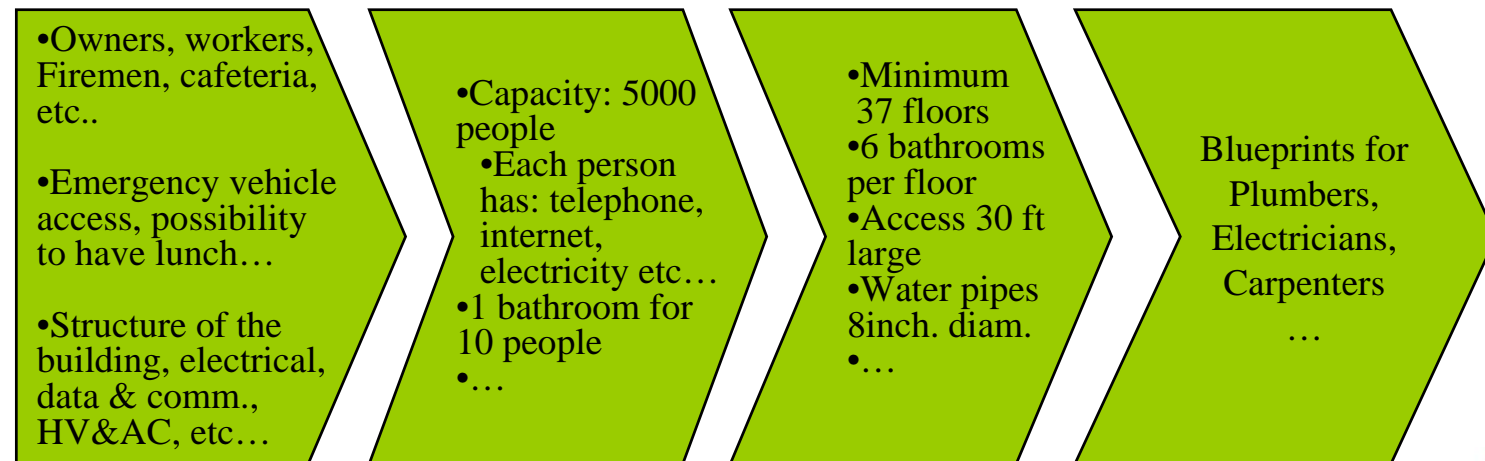
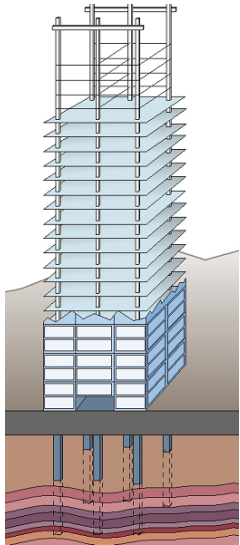

# IECSA Architecture Focus

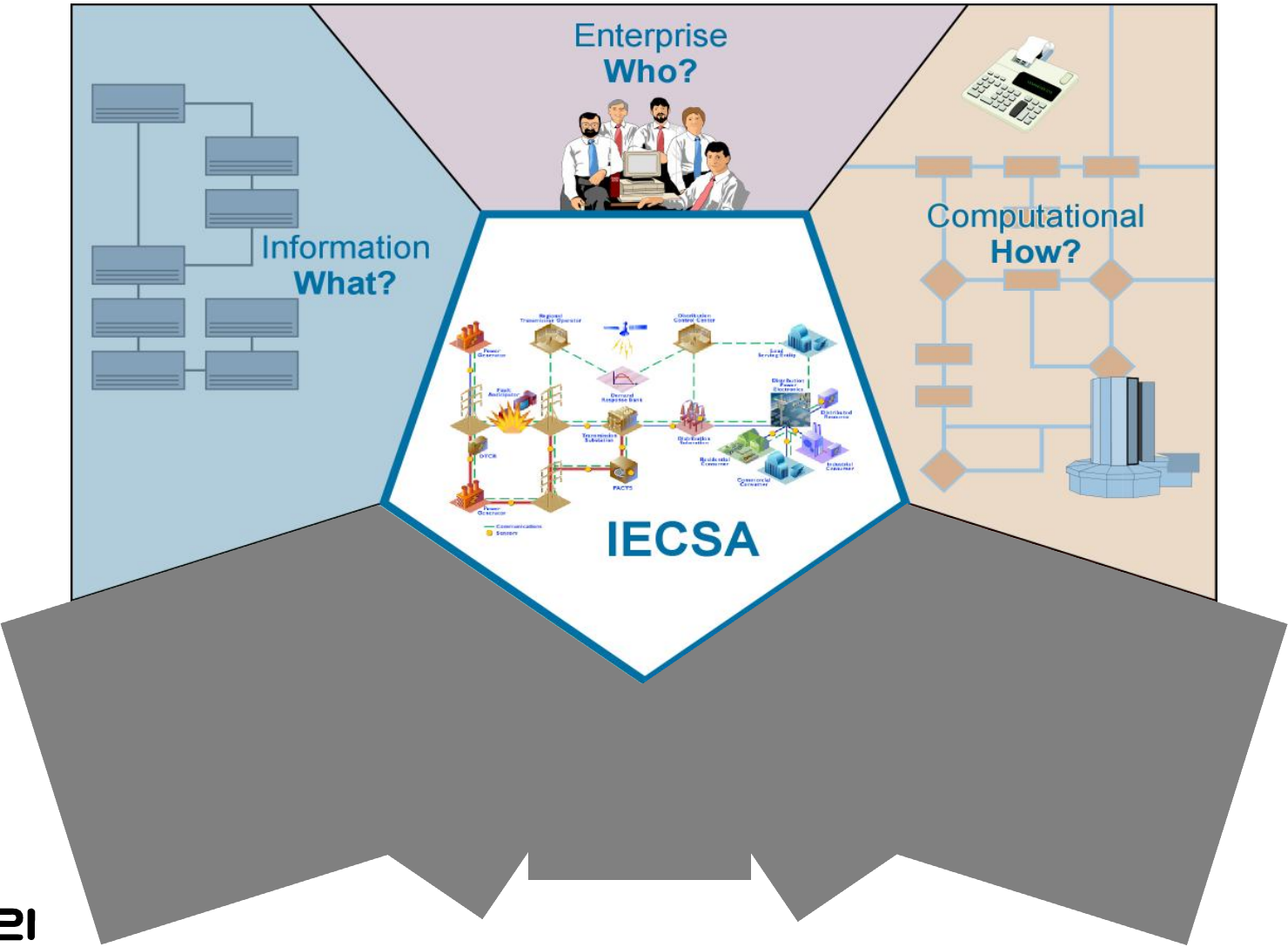

# Integrated Energy and Communications Systems Architecture

## Approach as Defined in RFP

- Task 1 Initial Scope and Stakeholder Definition
- Task 2 Assessment of existing Infrastructure Development
- Task 3 Requirements Development
- Task 4 Requirements Analysis
- Task 5 Architecture Definition and Analysis
- Task 6 Standards and Technology Assessment
- Task 7 Recommendations

# IECSA Overall Process Flow

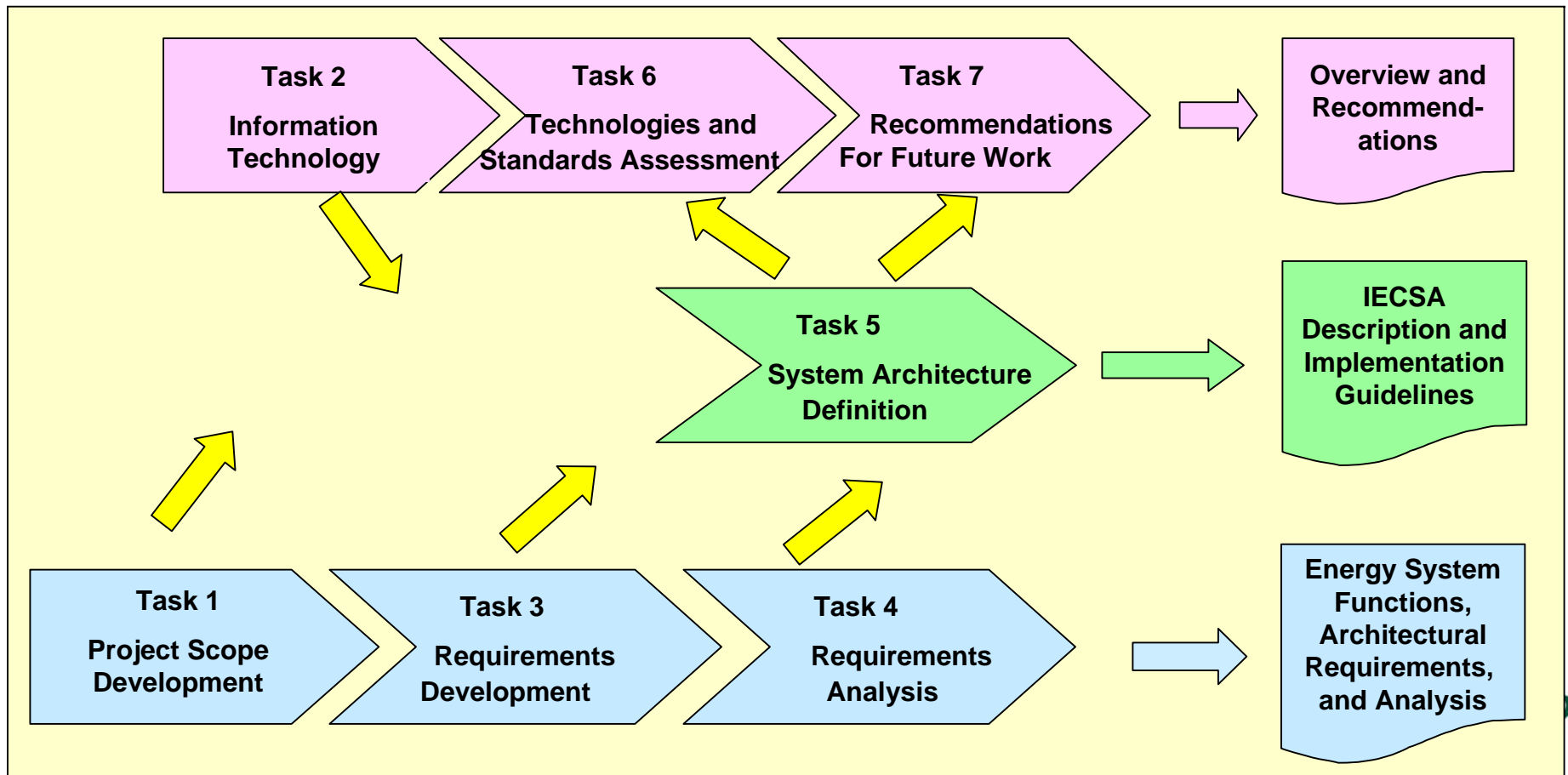
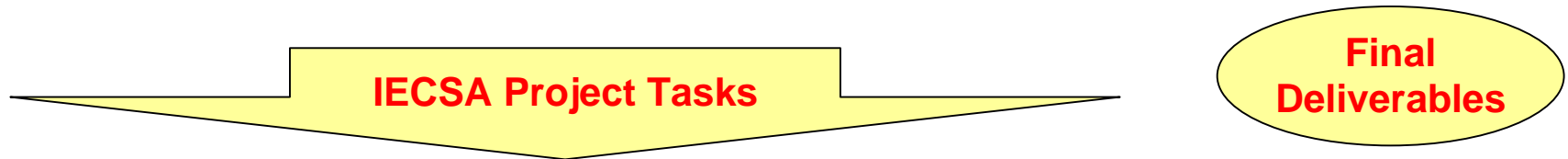



# Integrated Energy and Communications System Architecture Project Schedule

- Task 1 Initial Scope and Stakeholder Definition
- Task 2 Assessment of Existing Infrastructure Development
- Task 3 Requirements Development
- Task 4 Requirements Analysis
- Task 5 Architecture Definition and Analysis
- Task 6 Standards and Technology Assessment
- Task 7 Recommendations

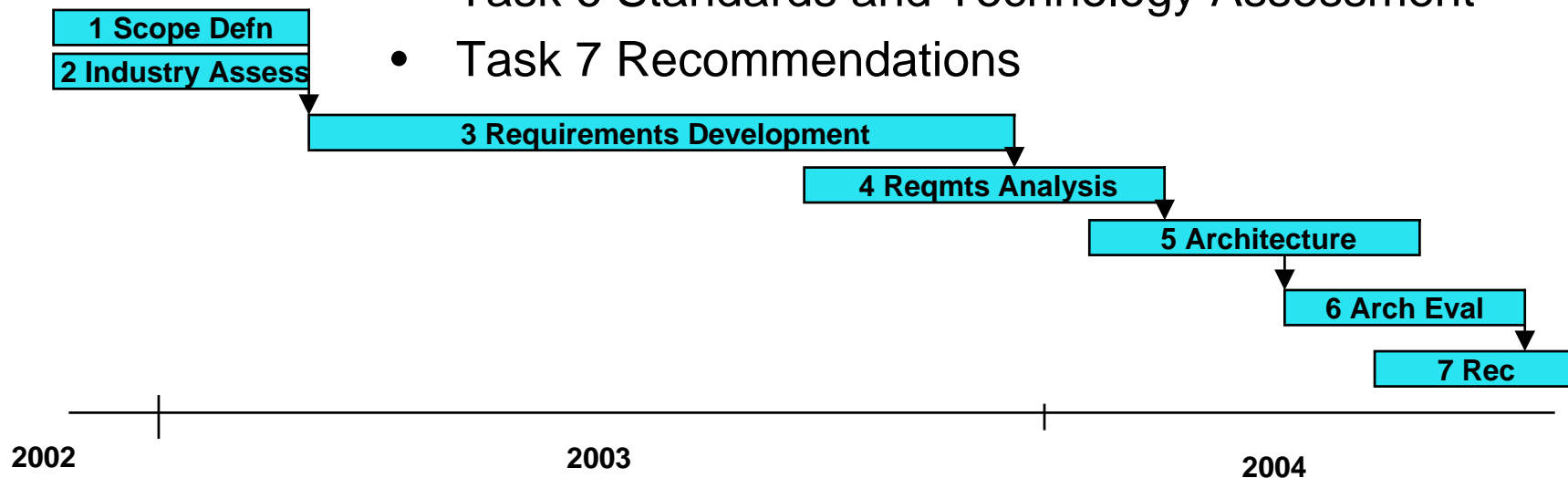

# Integrated Energy and Communications Systems Architecture

## Prior Industry Work to Integrate/Build Upon

- Utility Communications Architecture (UCA<sup>®</sup>) foundation work and field trials
- IEC TC 57 Working Groups: 9-16
- IEEE SCC-36,21,22,31 PES and CS
- ANSI C12 series, X12,
- EPRI/DOD Complex Interactive Networks
- Object Management Group (OMG) Utilities TF
- ISO JTC1 WG 25, CMU/SEI, INCOSE, EIA
- ASHRAE SPC135
- Other

# Systems Engineering Processes

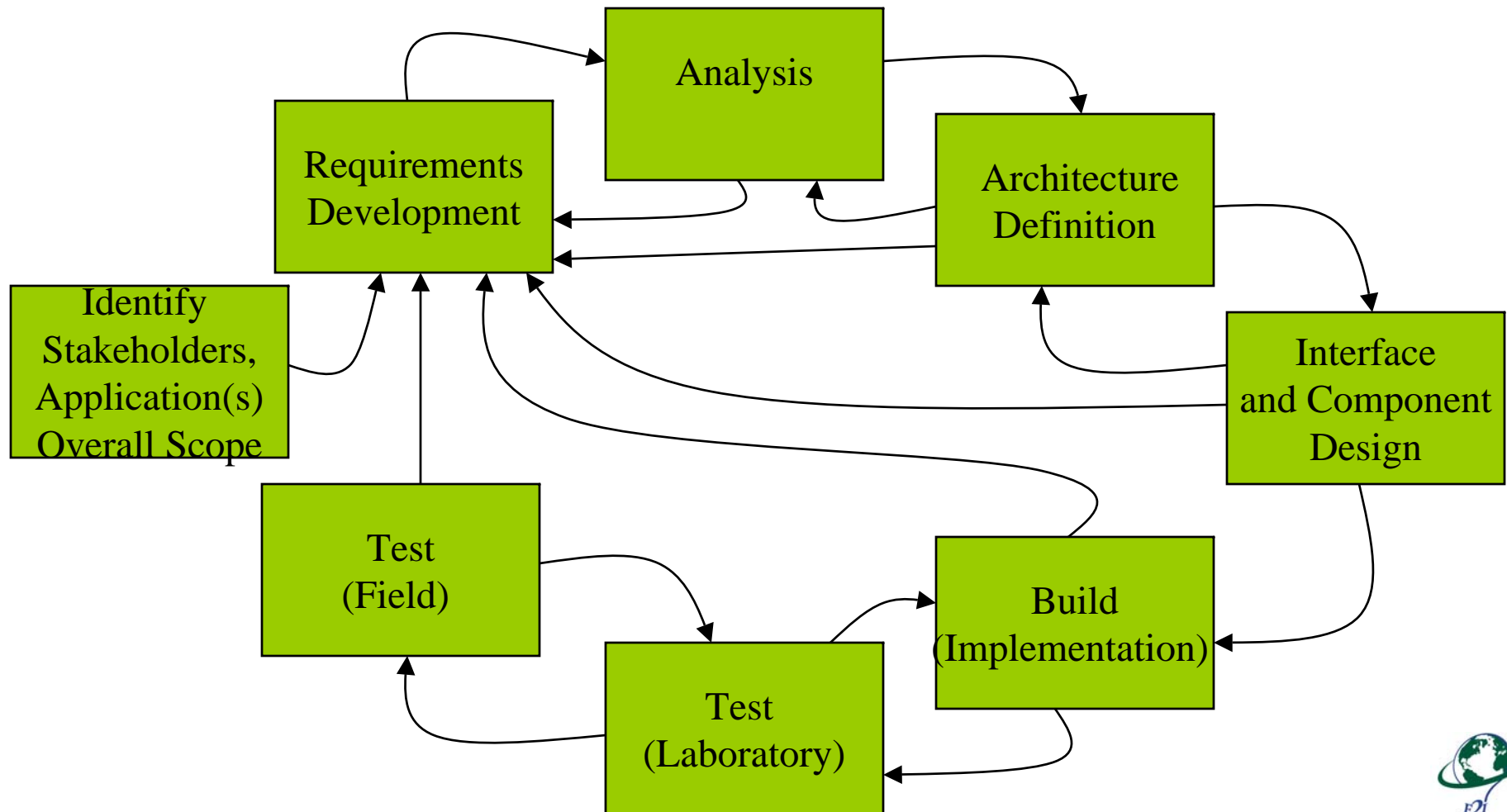

# IECSA Task 1 – Process

- Define the scope and identify priorities

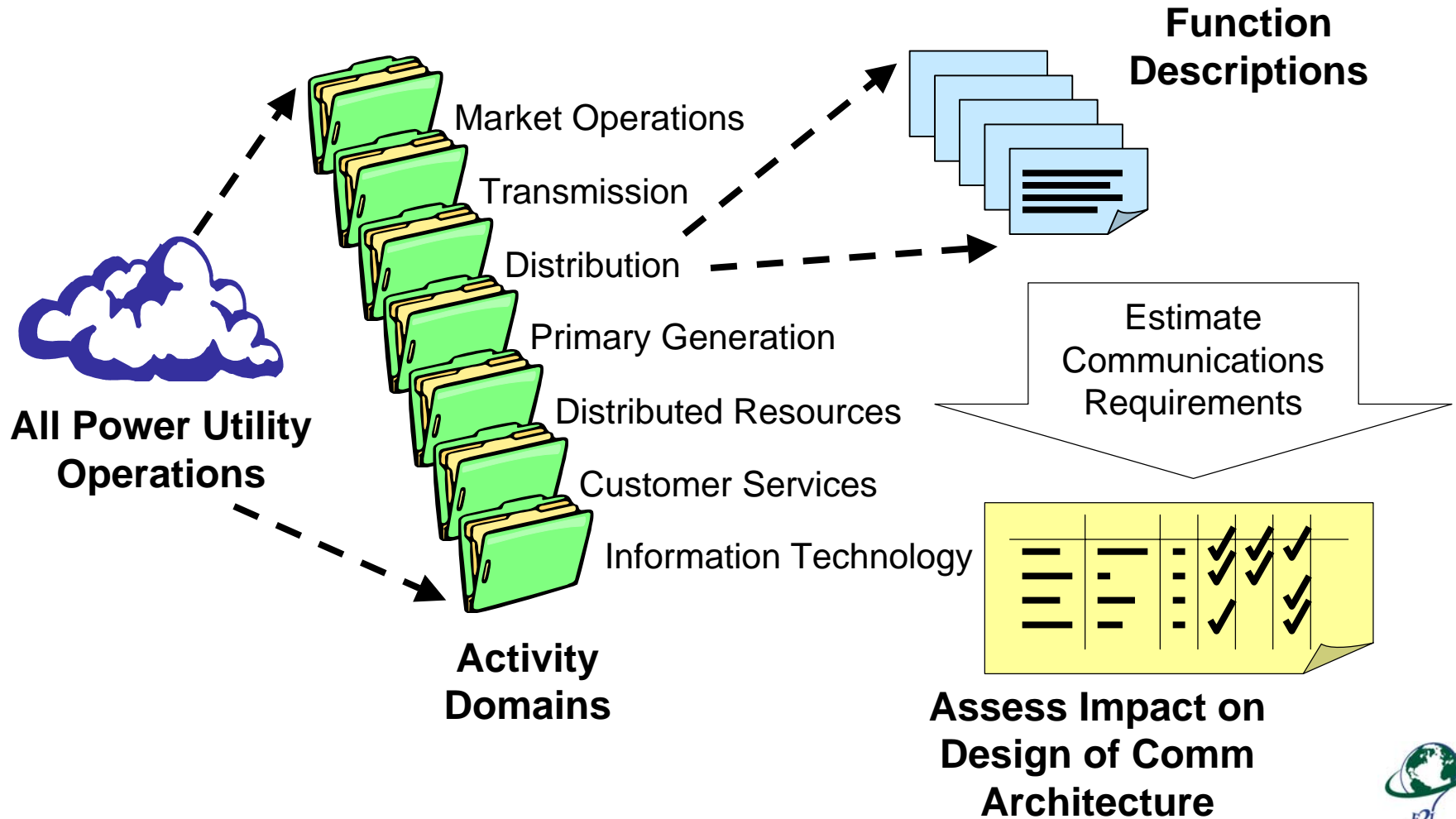

# IECSA Task 1 Methodology

- **Develop a high-level process** for capturing and describing all of the functional and system management requirements of electric energy operations
  - Organize operations into domains (e.g. market operations)
  - Identify all functions (e.g. distribution automation, generation dispatch) that are/will/could be used for operations
  - Describe each function very briefly
  - Identify key interfaces between entities for each function
  - Determine all system management requirements (data management, security, etc.) for supporting each function
- **Evaluate and rate** the impact of each functional and system management requirement on the design of an architecture
- **Identify and briefly assess those functions** that could have significant impact on architectural designs

# Task 1 – Analyzing Function

**Day Ahead Market: Energy Marketers Submit Day-ahead Energy Schedules**

## Enterprise Activity Spreadsheet

**PURPOSE** of SCHEDULING COORDINATORS SUBMIT DAY-AHEAD ENERGY SCHEDULES function  
**IS TO** for Scheduling Coordinators or other entities to submit 24-hour energy schedules in the Day-Ahead market, and the RTOs/ISOs to validate the submittals (depending on market design),  
**DIRECTLY INVOLVING** Scheduling Coordinators (or other entities), RTOs/ISOs, Auditors, Other Market Participants,  
**PERFORMING** Energy schedule submittal and validation,  
**WITH KEY INTERFACES** between

1. Scheduling Coordinators and RTOs/ISOs
2. RTOs/ISOs and neighboring RTOs/ISOs
3. RTOs/ISOs and Web Server for Market Participants,

**WITH COMMUNICATION CONFIGURATION REQUIREMENTS** of One to many WANs (probably Internet-based) between RTOs, Scheduling Coordinators, other Market Participants, Regulators, and Auditors,  
**WITH COMMUNICATION SERVICE QUALITY REQUIREMENTS** of High availability, rapid response, high data accuracy, and high data frequency needed for interactions between RTOs and Market Participants to ensure fairness in any energy scheduling process,  
**WITH SECURITY REQUIREMENTS** of High security in all areas because of fairness requirements with market rules and financial implications,  
**WITH DATA MANAGEMENT REQUIREMENTS** of Large database for energy schedules, requiring timely access, frequent updates, and data exchanges across organizational boundaries,  
**WITH CONSTRAINTS/CONCERNS** of a few special constraints, since WAN connections to Market Participants, but systems and applications are new and/or changing to meet changing market environments.

## Analysis Results Range: 0 to 3

- **Configuration = 0** because using pre-existing communication systems and/or the Internet
- **Performance = 3** because timely delivery and response (on the order of minutes) between RTOs/ISOs and Market Participants is critical to meeting market rules.
- **Security = 3** because interactions with Market Participants involves many only partially trusted parties, possibly with connections over the Public Internet.
- **Data Management = 3** because Market Participant characteristics will change frequently and large volumes of new types of data
- **Constraints = 2** because systems and applications are new and/or changing to meet changing market environments

# Overview of the Domains

- **Market operations**, including energy transactions, power system scheduling, congestion management, emergency power system management, metering, settlements and auditing.
- **Transmission operations**, including optimal operations under normal conditions, prevention of harmful contingencies, short term operations planning, emergency control operations, transmission maintenance operations and support of distribution system operations.
- **Distribution operations**, including planning and real-time timeframes, optimal operations under normal and emergency conditions, support of transmission system operations, asset management, advanced distribution automation of distribution systems with significant DR penetration.
- **Customer services**, including AMR, time-of-use and real-time pricing, meter management, aggregation for market participation, power quality monitoring, outage management and, in-building services and services using communications with end use loads within customer facilities.
- **Primary generation**, including automatic generation control, generation maintenance scheduling and coordination of wind farms.
- **Distributed resources**, including participation of DR in market operations, DR monitoring and control by non- utility stakeholders, micro-grid management and DR maintenance management.
- **Federated System Management functions**, including bandwidth management, security management, network device configuration, address management, and database replication and management.

# Task 1 - Results

- Definition of Project Scope
- Breadth of functions
- Tool Selection
- Collaboration Environment
- Validation of Process
- Examples of Scenarios

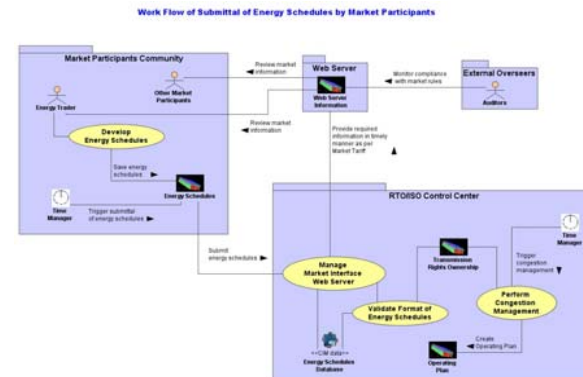
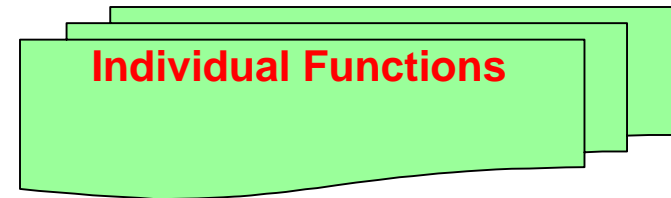

Example of Information Flow Diagram of Submittal of Energy Schedules



## Task 2 – Industry Assessment

- What is the current state of communications technology?
- Which technologies might be suitable for the architecture?
- Which organizations are developing appropriate technologies?
- What is the scope of the work ahead, especially Task 6: Standards Assessment?

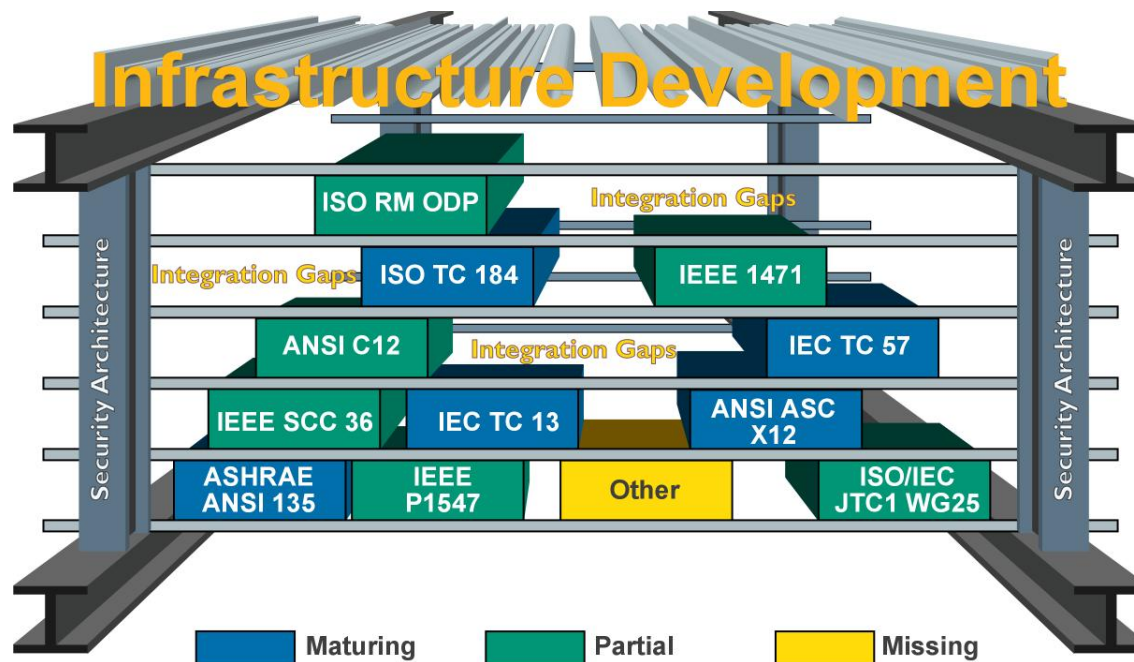

# Task 2 - Process

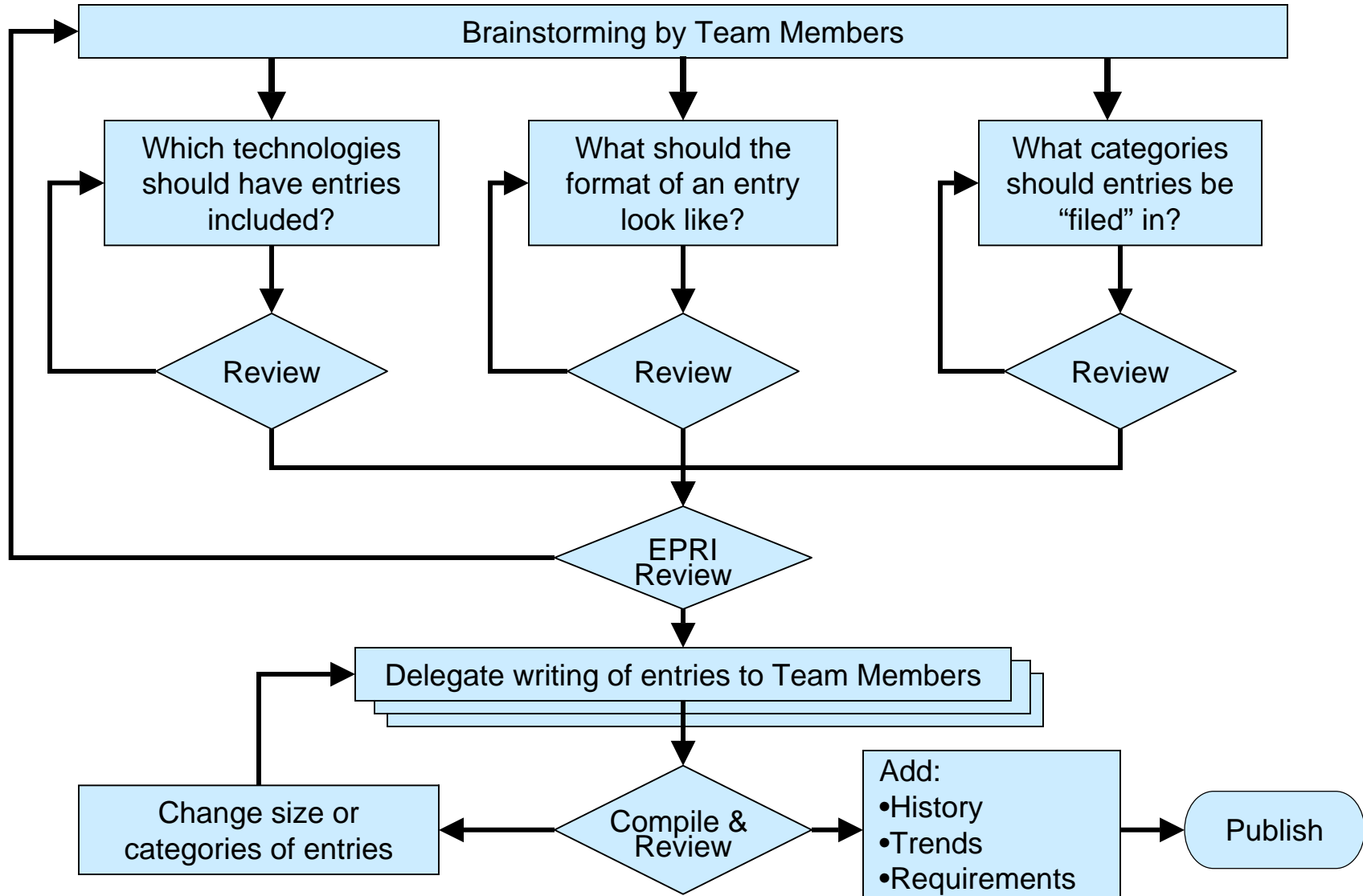

# Task 2 - Results

## Table of Contents

1. Introduction
2. Issues in Developing an Architecture
  - Drivers
  - History
  - Requirements
3. Utility Technologies
4. In-Building Technologies
5. Networking Technologies
  - Standards Organizations
  - Government and Regulatory
  - Consortia and Trade Organizations
  - Individual Private Organizations
6. Enterprise Info Technologies
7. Systems Engineering
8. Advanced Research
9. Index

### 5.1.2.3. IEEE 802.11 Wireless Local Area Network (LAN)

URL: <http://www.wirelessethernet.org/OpenSection/index.asp>

**Description:** This standard provides wireless connectivity to a mobile or portable equipment within a LAN area. The IEEE 802.11 standard specifies both the physical (PHY) and medium access control (MAC) layers of the network. The physical layer can use either direct sequence spread spectrum, frequency hopping spread spectrum, or infrared (IR) pulse position modulation. The MAC layer specifies CSMA/CA protocol. Security is one of the major concerns of wireless LANs in general and this technology in particular. IEEE 802.11a and 802.11b have data rates of 55 and 11 Mbps respectively. IEEE 802.11b is currently in widespread use. Wireless Fidelity (WIFI) Alliance certifies interoperability of WIFI technology product using 802.11b.

**Keywords:** LAN, Wireless, Physical layer, MAC layer, Spread spectrum, Infrared, Mobile computing, Technology VP

# Task 3 Process and Interim Results

Identify key functions from Task 1 Enterprise Activity Spreadsheet to shine a spotlight on (Cones)



Develop domain template as a guideline for domain experts to provide functional and non-functional requirements, bridging expertise Between power systems and distributed computing systems



Capture requirements of these key functions in the domain template using IECSA Team and Stakeholder domain experts. Make sure to Identify architecturally significant issues for analysis in Task 4

Iteratively refine the information captured until both power engineering and distributed computing experts are satisfied with the details of the Enterprise Activity requirements and architectural issues.



Develop functional and information flow diagrams of these key Enterprise Activities



Document the results to be reviewed by stakeholders and used in Tasks 4+.



## Task 3 - Stakeholder Engagement

### Process under way

- Covers breadth of stakeholder communities
- Priority is identifying those who can
  - complement current analysis
  - provide quality input on analyses

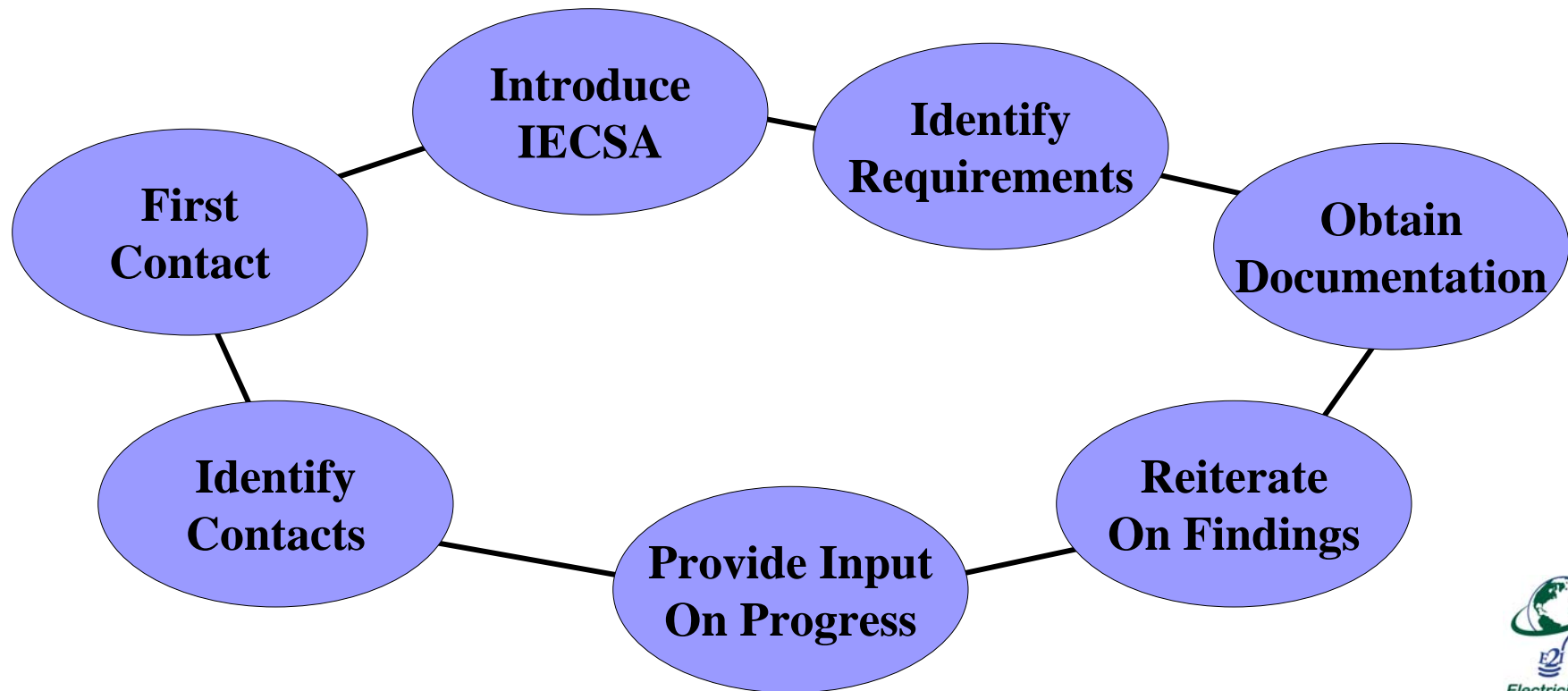

## Stakeholder Targets

- Business: Project funders, government (GSA, DOD), utilities, vendors
- Regulatory: PUCs, FERC, NERC, FBI, NIST
- Technical perspective input
  - Standards participation colleagues – esp. utilities
  - User group participants
  - Selected organizations (NIST, NSA, DOD, GTI)
  - Standards outside of traditional “utility”...(ITU, API, ...)

# Focusing on the Electric Grid

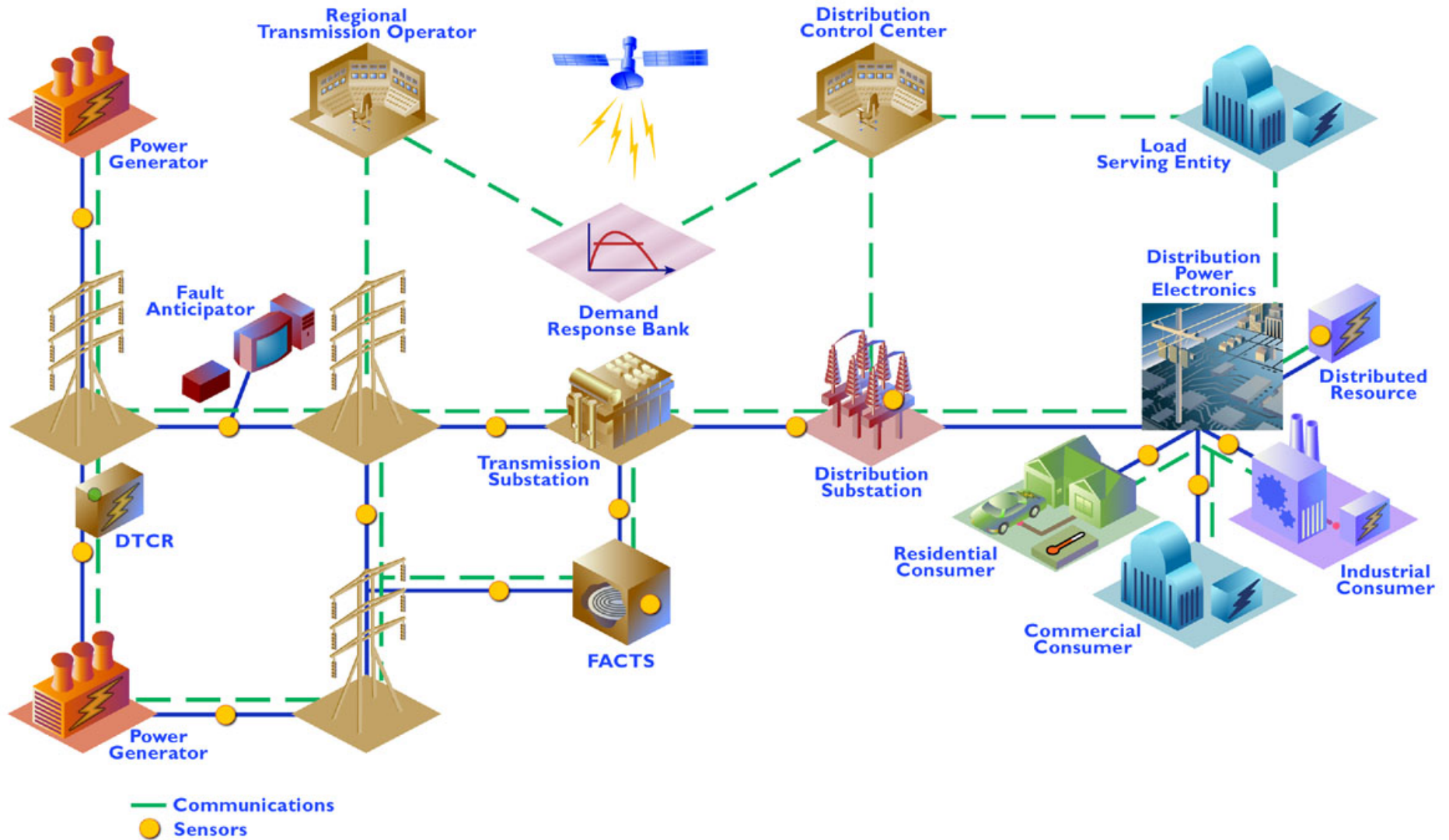

# Wide Area Protection and Control

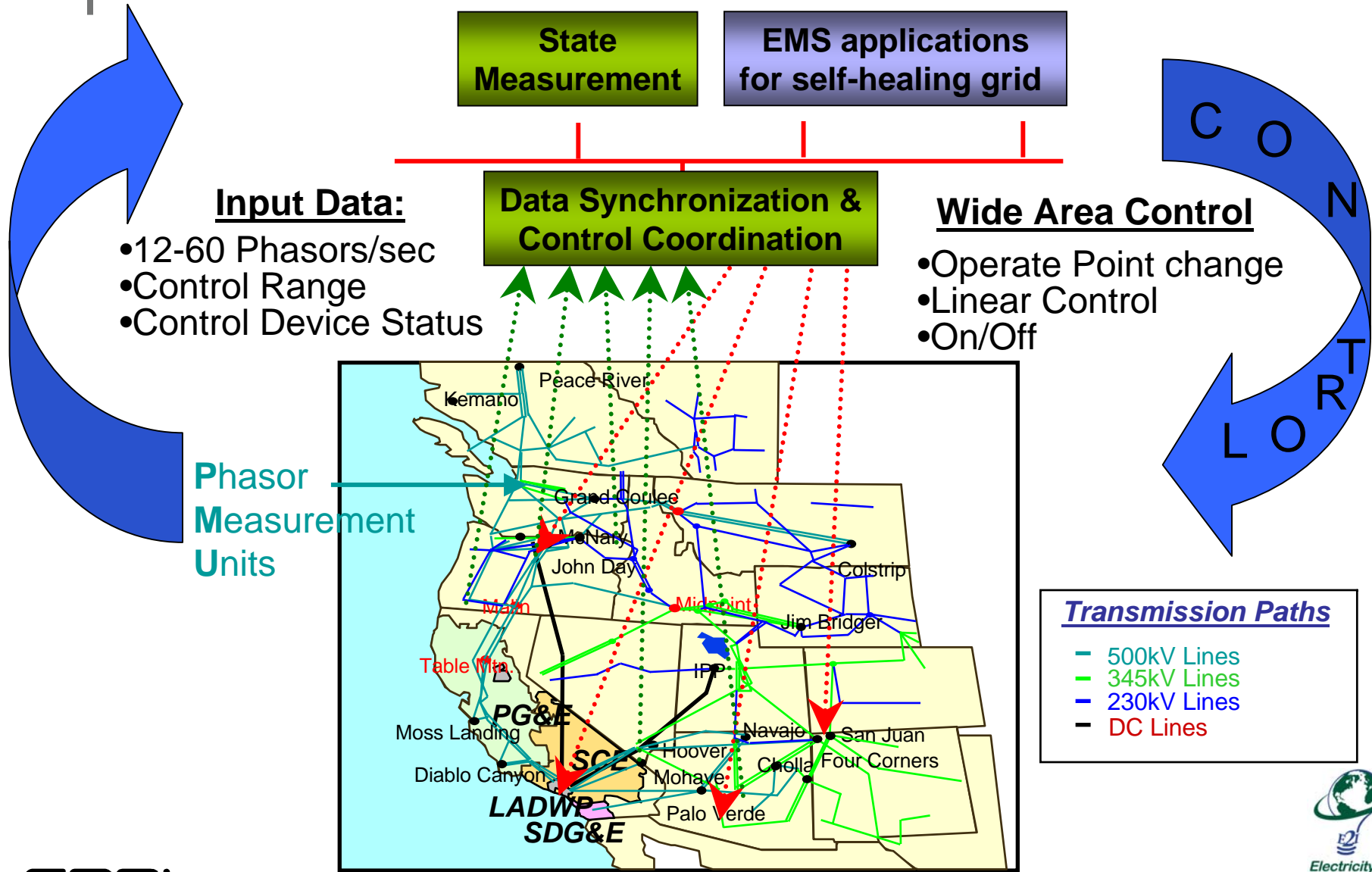



# WACS-WAMS Information Flow Diagram

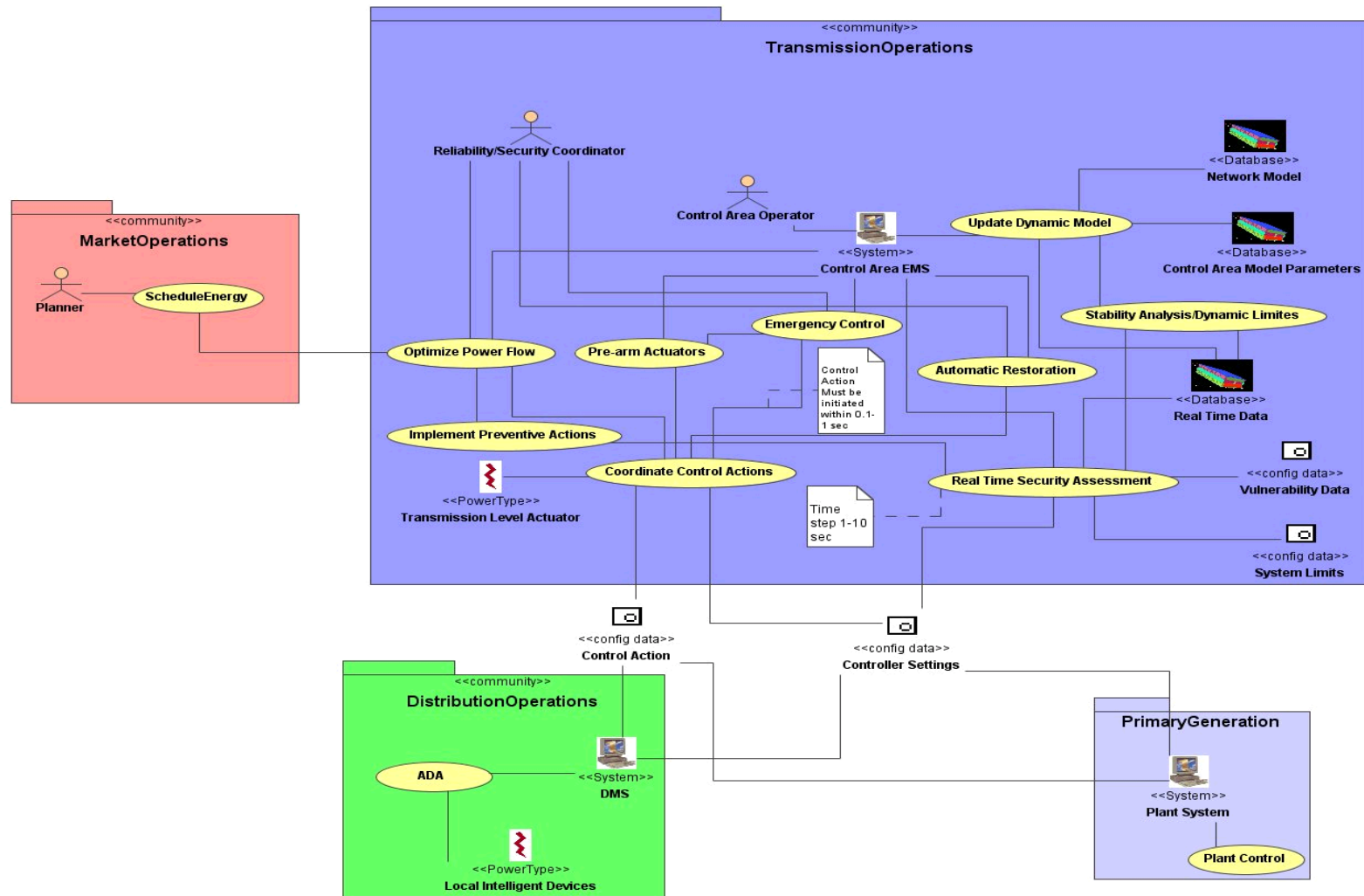

# Advanced Distribution Automation (ADA)

What Do We Need to Know to Optimally Control Distribution Operations?

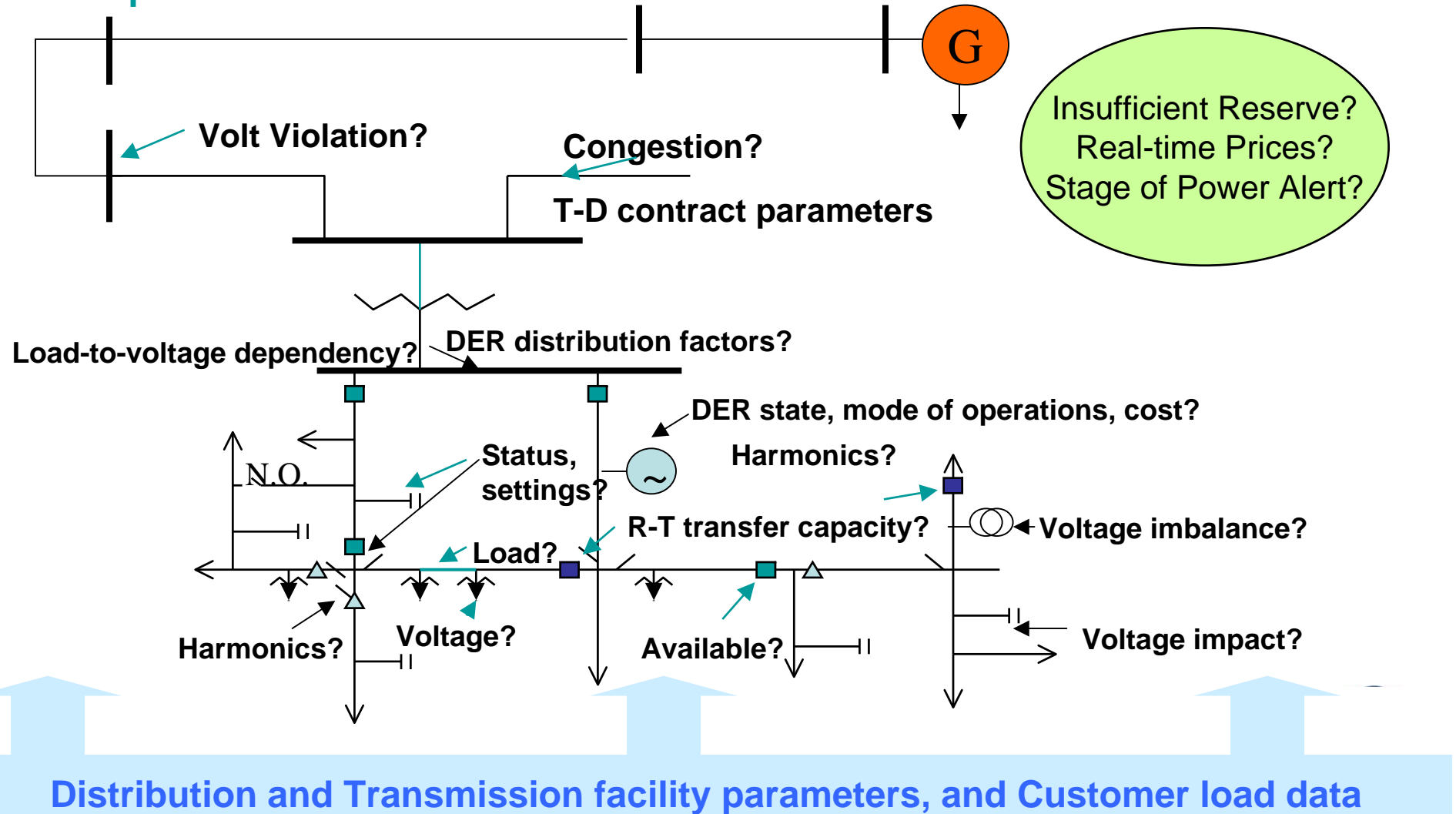

# Distribution Operation Modeling and Analysis

## Distribution Operation Modeling and Analysis (DOMA)

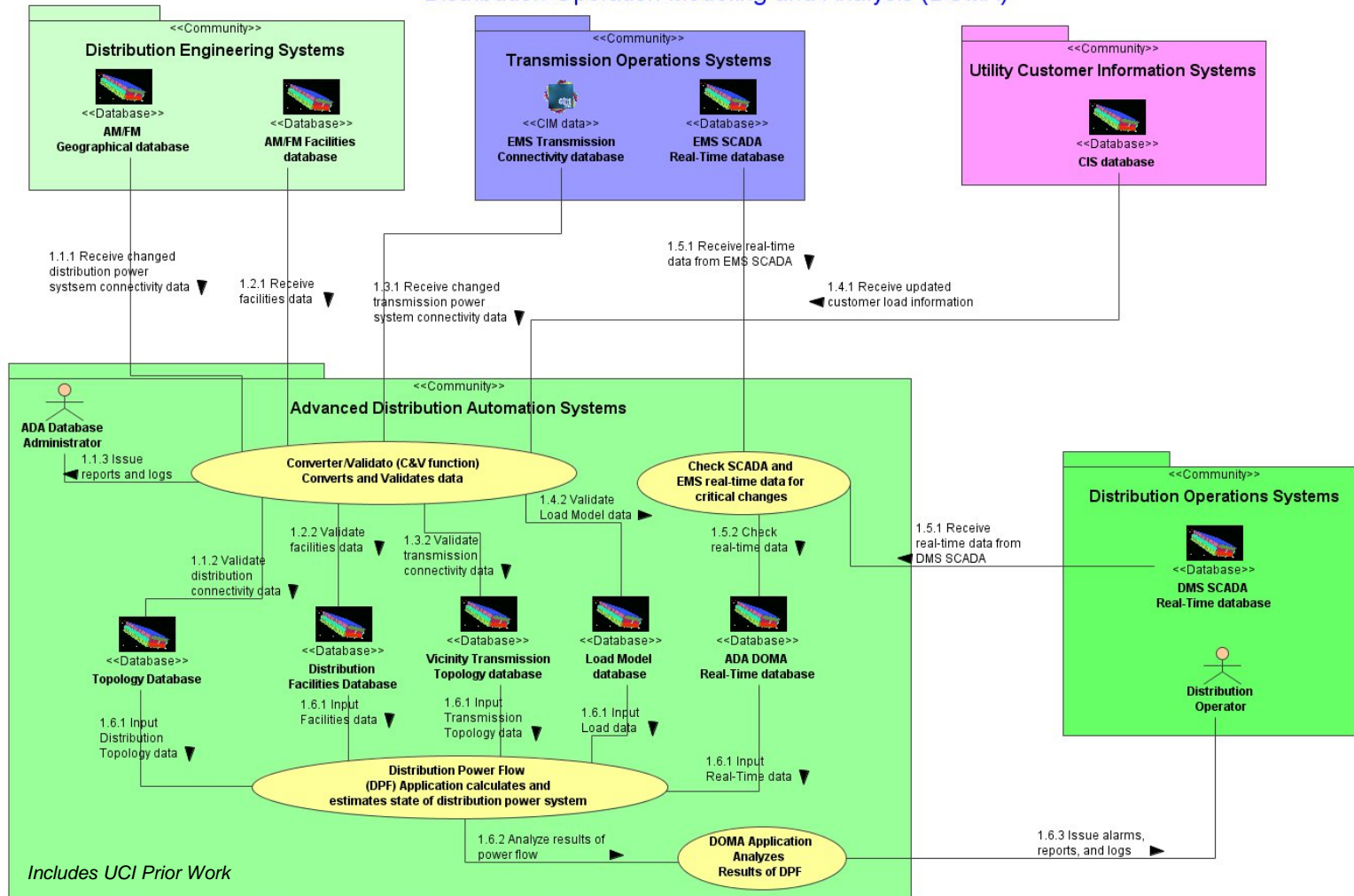

# Customer Interface and Operations

**Customer Systems: In-building networks and networked equipment**

**Wide-Area Communications and Distributed Computing**

**Energy Industry Networked Applications**

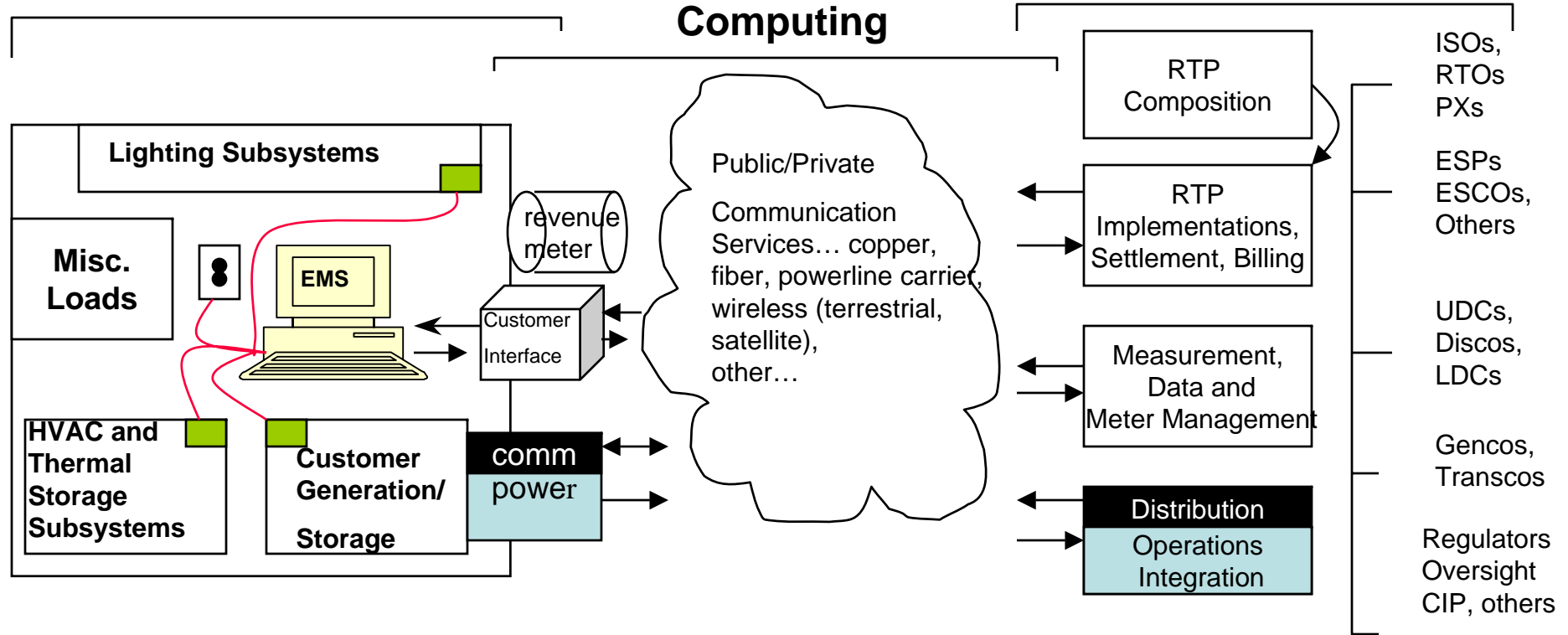

Customer Communication System Architecture

# RTP Function Work Flow

Real-Time Pricing Enterprise Activity (RTP Function)  
 Showing Interactions and Information Flows between Applications

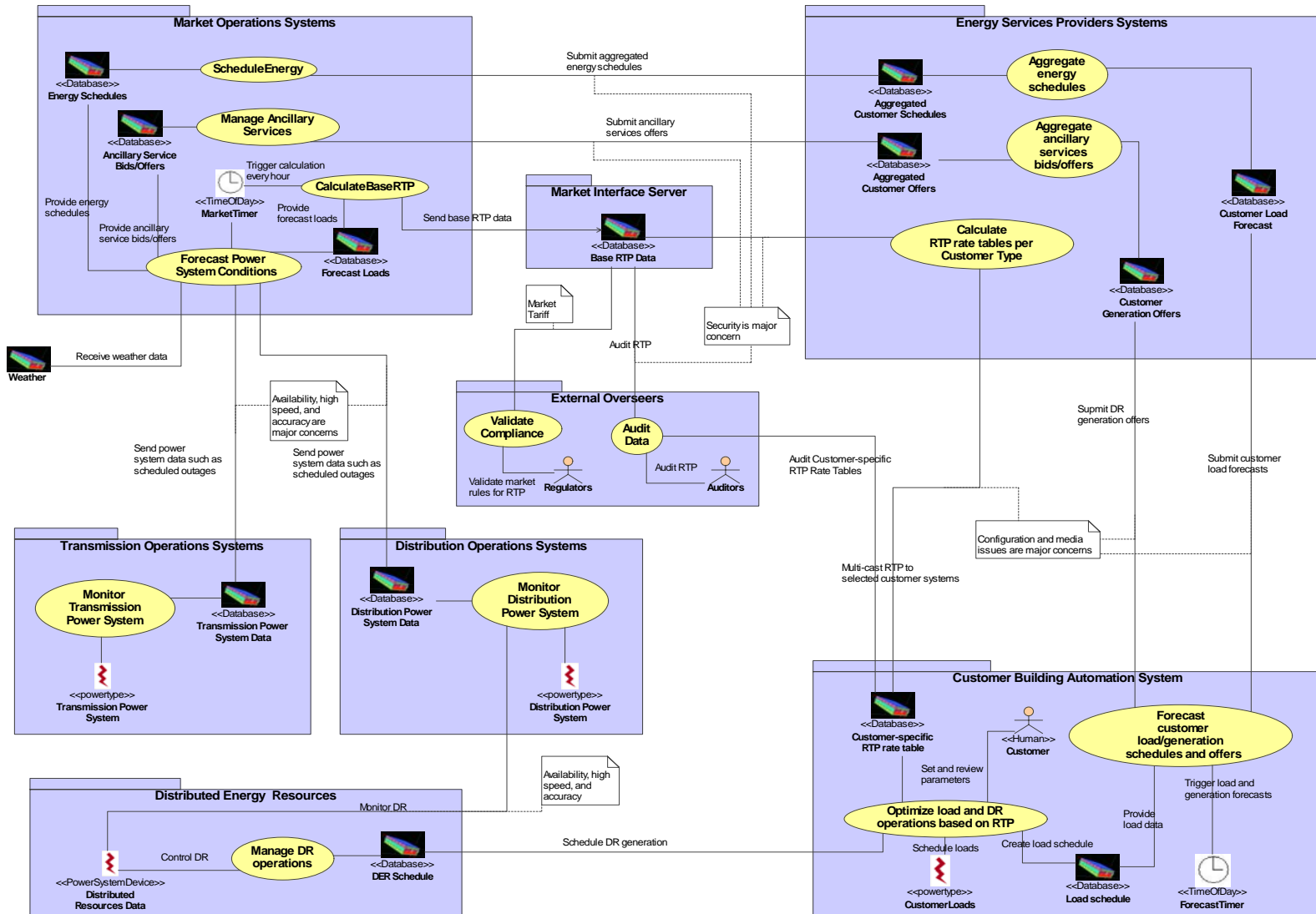

# Future With No Architecture

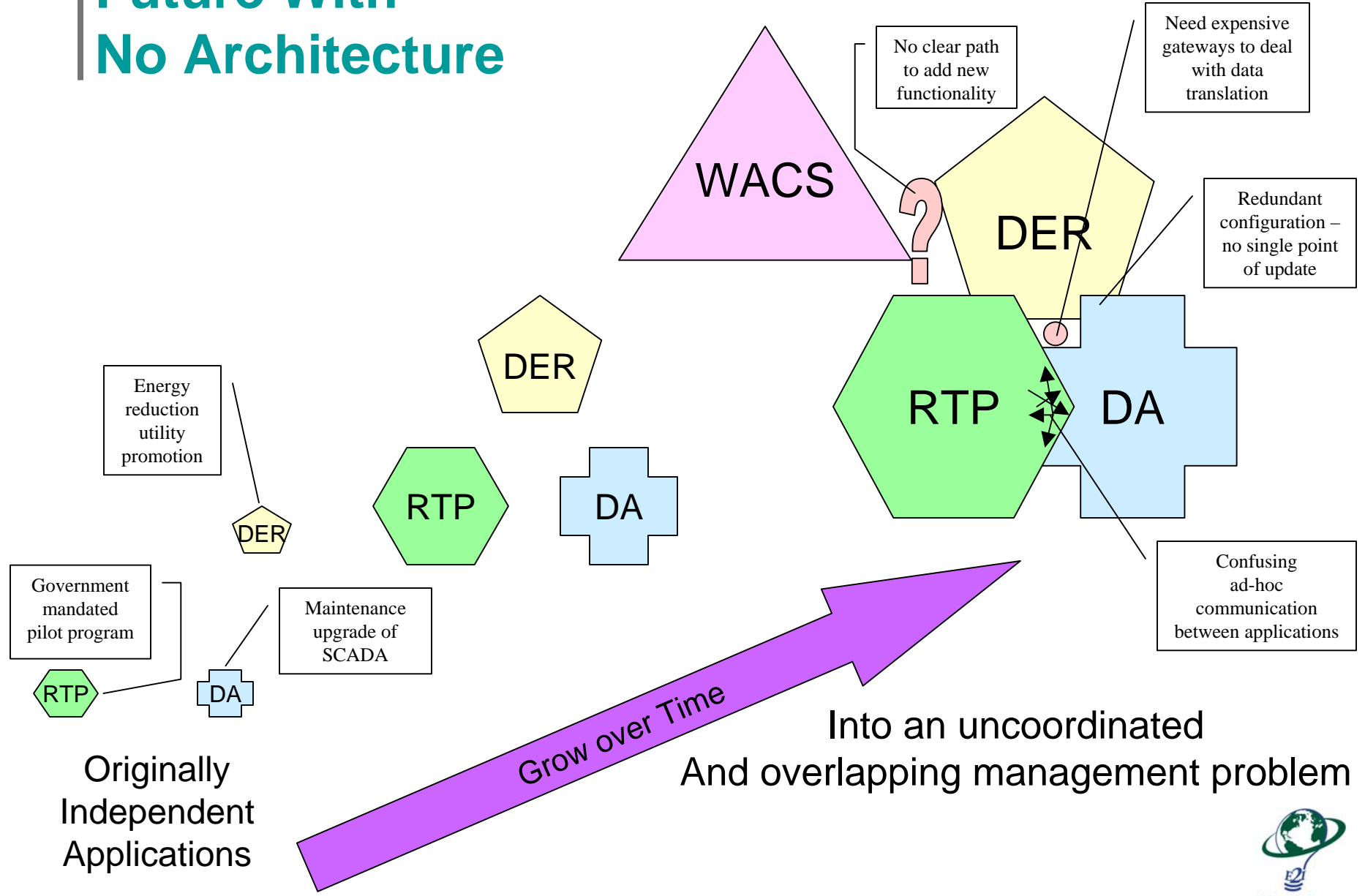

Into an uncoordinated  
And overlapping management problem

# Future With An Enterprise Architecture

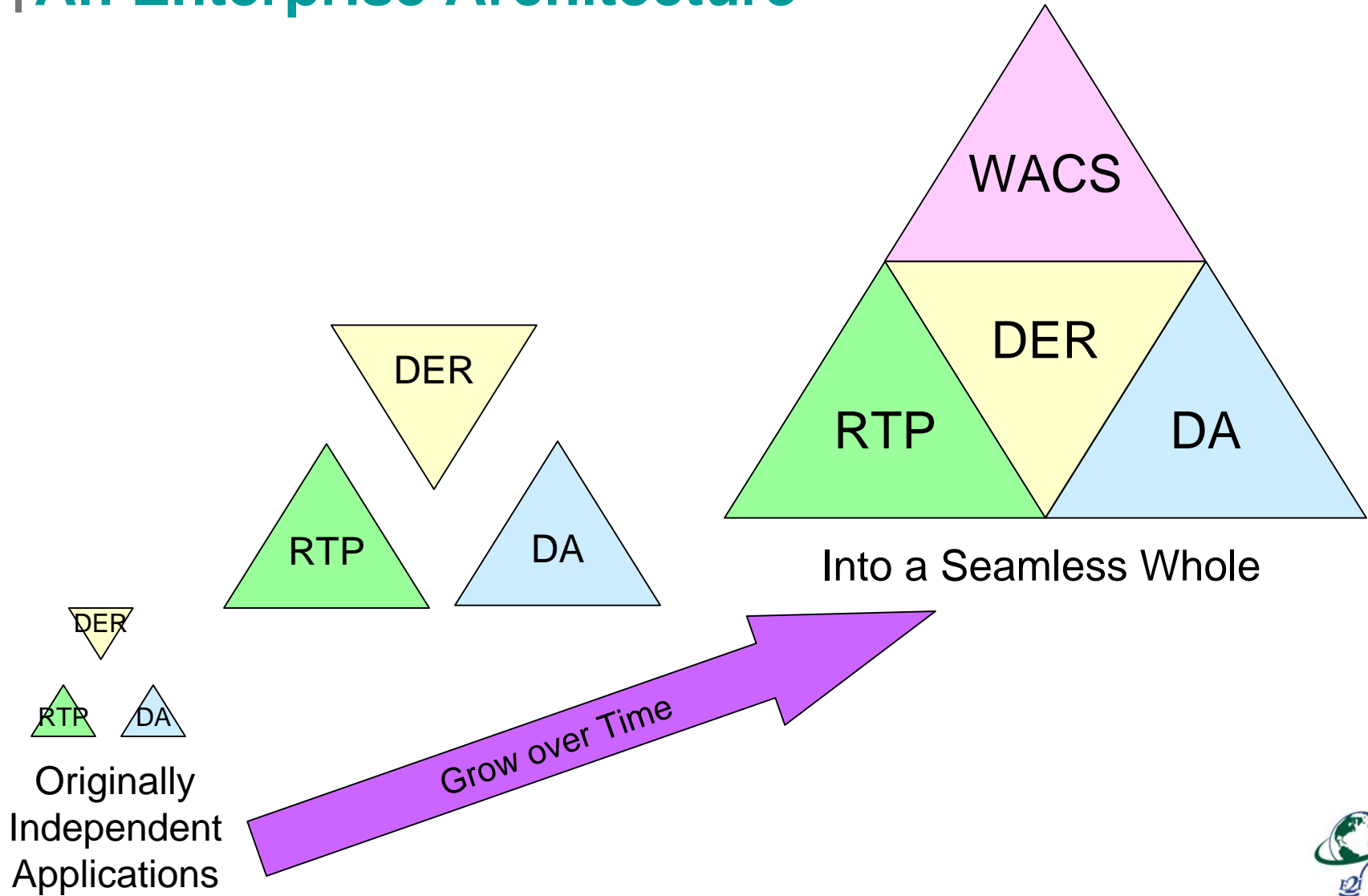

# Task 4 Process: Requirements Analysis

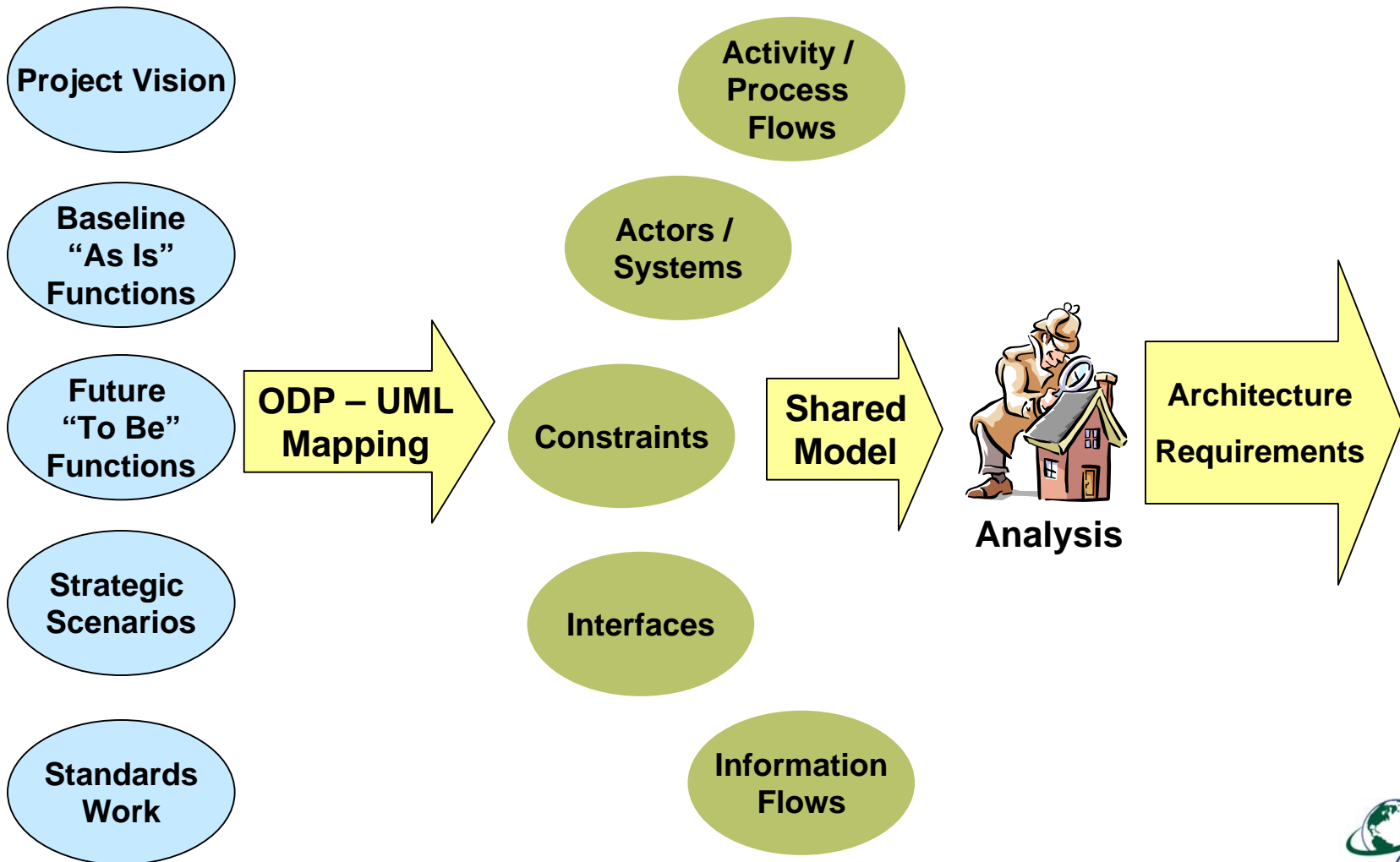



# Tasks 5-7 Expected Processes

- Pick up from Task 2 list of existing technologies
- Extract architectural requirements from Task 4 RM-ODP/UML analysis
- Evaluate existing industry standards, including CIM, 61850, Web services, ebXML methodologies, security techniques and solutions, network management, data management, etc.
- Develop cross-reference between the architectural requirements and the possible technology solutions, referring back to Task 3 results for validation
- Identify gaps and alternatives, and analyze expected future directions of these technologies
- Develop IECSA Reference Architecture, covering existing solutions, future probable solutions, gaps and issues, legacy system migration strategies, etc.

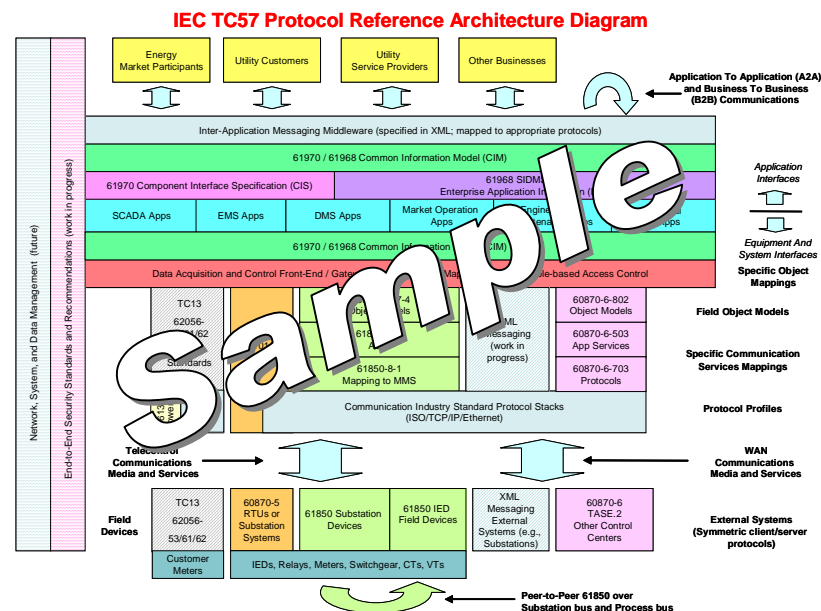

# Final Deliverables

- **IECSA Executive Overview and Recommendations**
  - Value Story
  - Methodology used by Project Team
  - Executive level overview of the IECSA
  - Recommendations for standard bodies
  - Recommendations for future efforts
- **IECSA Description and Implementation Guidelines**
  - Guidelines for Using the IECSA Documentation Set
  - The IECSA – A Reference Architecture
    - **Architecture Definition**
    - **Common Services and Standard Protocols**
    - **Specific Technologies and Standards**
  - Example Usage Scenarios for the IECSA
- **Energy System Functions, Architectural Requirements, and Analysis**
  - Energy System Domains and Related Functions
  - Key Requirements of Energy System Functions
  - UML Models of Functions and their Architectural Issues
  - Analysis of Architectural Requirements
  - Analysis of Key Existing Standards and Technologies

**IECSA Executive Overview  
And Recommendations**

**IECSA Description and  
Implementation Guidelines**

**Energy System Functions,  
Architectural Requirements  
and Analysis**

# How to Use the IECSA

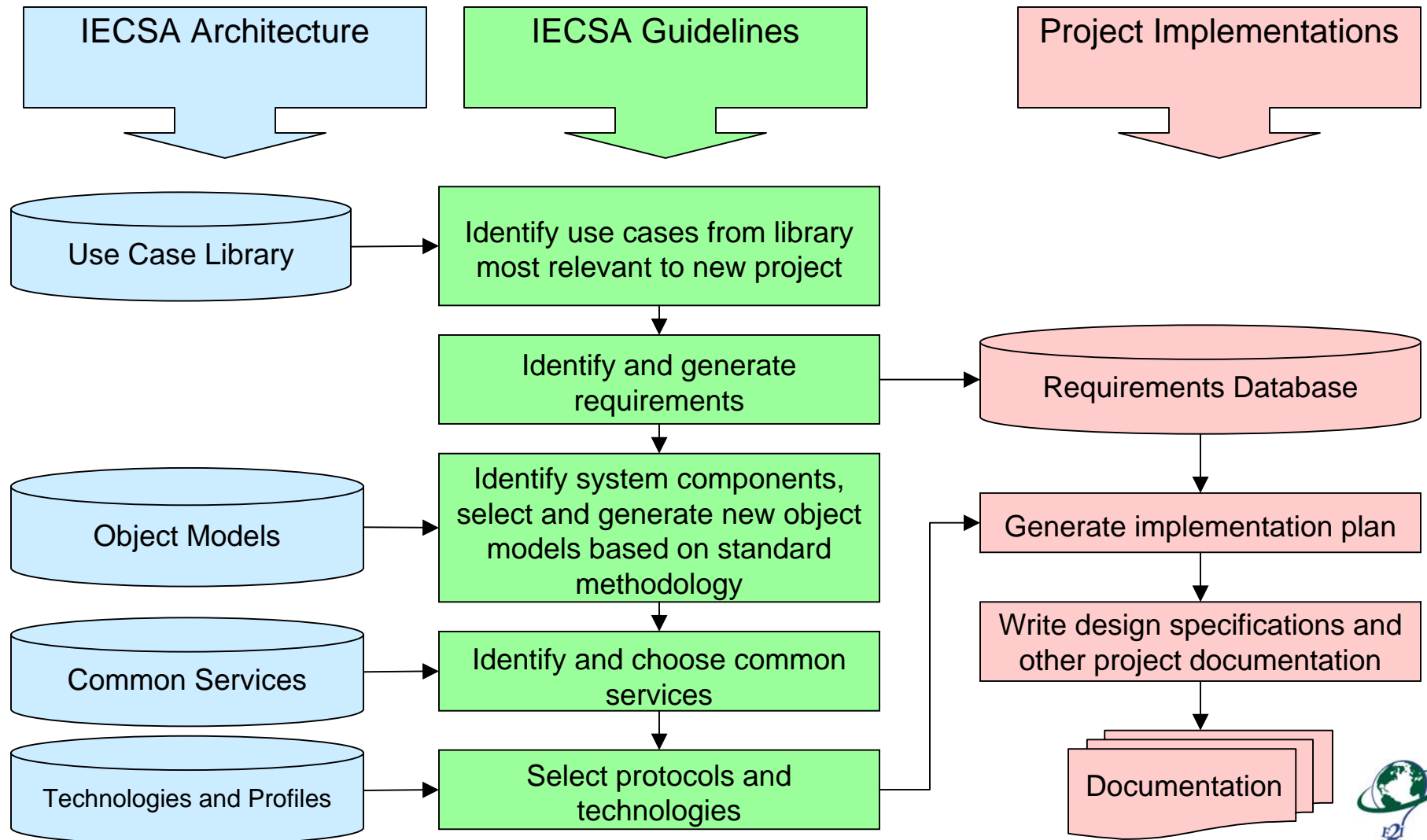

# When to Use the IECSA – Some Examples

- Utility *develops requirements* for a new SCADA system
- Systems integrator *responds to an RFQ* for a utility communications network
- Hardware vendor *plans new product* development
- Regulator *develops new legislation* for real-time pricing
- A&E firm *designs a facility* linked into the utility communications network
- Facility engineer *considers options* for real-time pricing

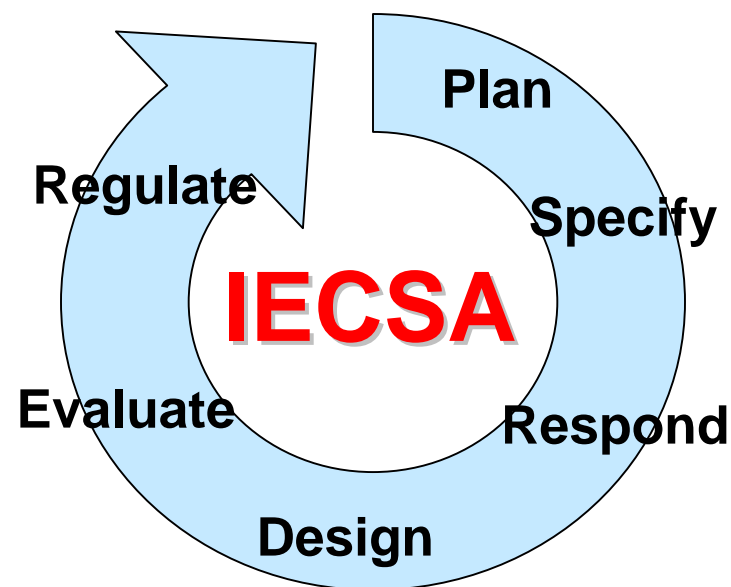

# IECSA Demonstration Projects

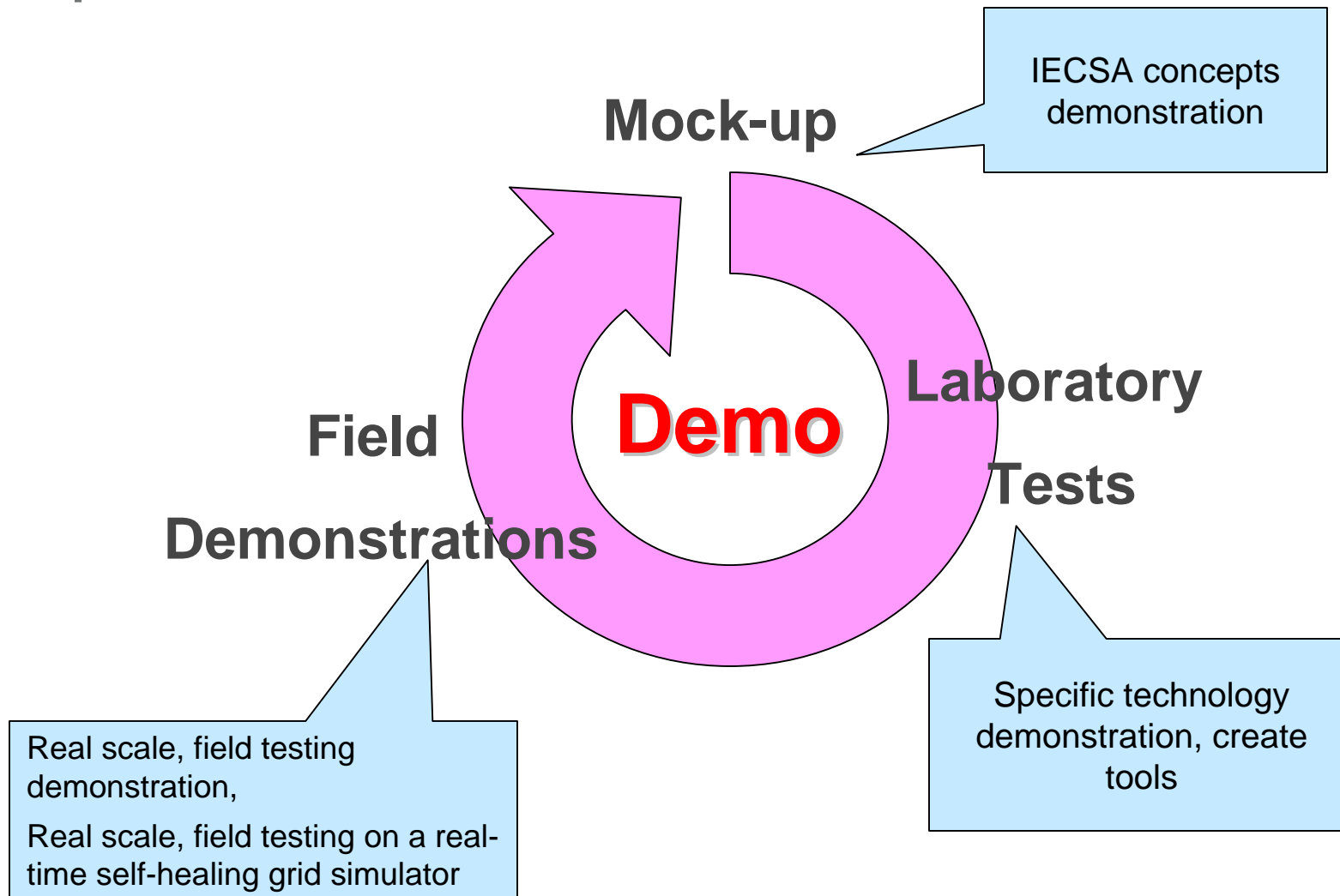

# IECSA Demonstration Goals

Use as much as possible:

- Existing demonstration projects
- On-going standards efforts
- Partnerships
- Incremental demonstrations
- Technology transfer opportunities
- Opportunities
  - Location
  - Facilities
  - Funding
  - Support
  - Other resources



# The Public Face of IECSA

